

ARTESYN LGA110D SERIES

Non Isolated DCDC Converter

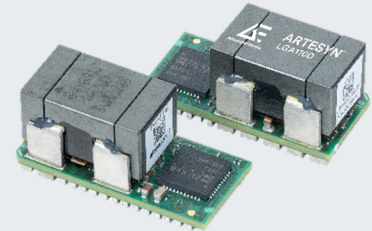

PRODUCT DESCRIPTION

The LGA110D power supply features a 7.5 to 14Vdc input voltage range and a 350W output power.

The LGA110D is a new design of high performance DC-DC converter. LGA110D has 2 phase design. It offers a total 350W output with just dimensions of 27.5 mm x 12.8 mm x 13.4 mm. State-of-the-art circuit topology provides a very high efficiency up to 96% which allows an operating temperature range of -40°C to +85°C.

Further features include remote On/Off, variable output voltage as well as over-current protection, over-voltage protection, and over-temperature protection.

SPECIAL FEATURES

- 2 phase design
- Dual or single output configuration possible
- High efficiency up to 96%
- Small size 27.5 mm x 12.8 mm x 13.4 mm (LxWxH)
- PMBus™ supporting
- No minimum load requirement
- Wide operating temperature range
- Exceptional power density 203W/sq-in
- Automatic loop compensation
- Excellent transient response
- Analog or Digital control
- Tape and reel packaging
- Reflow compatible
- Possible to stack up to 8 phases for 440A

- I-mon and T-mon supported
- IPC9592B compliant

SAFETY

- Designed to meet EN60950-1 and EN62368-1

WARRANTY

- 2 years (consult factory for extended terms)

AT A GLANCE

Total Power

350Watts

Total Current

110A (Single)

55A (Dual)

Output Voltage

0.5 to 5Vdc

of Outputs

Dual or Single



MODEL NUMBERS

Standard	Input Voltage	Output Voltage	Minimum Load	Maximum Load
LGA110D-01DADJJB	7.5-14Vdc	0.5 ¹ -5.0Vdc	0A	110A

Note 1 - 0.5V can only be set via PMBus command.

Order Information

LGA	110	D	-	01	D	ADJ	J	B
①	②	③		④	⑤	⑥	⑦	⑧

①	Model series	LGA: Series Name
②	Output current	110: Rated Output Current = 110A
③	Control	D: Digital Control POL
④	Input Voltage Range	01: 7.5 to 14Vdc
⑤	Number of Outputs	D: Dual Output
⑥	Output type	ADJ: Adjustable Output
⑦	Rohs Compliance	J:Pb free (Rohs 6/6 compliant)
⑧	Option	B: New designed version

ELECTRICAL SPECIFICATIONS

Absolute Maximum Ratings

Stress in excess of those listed in the “Absolute Maximum Ratings” may cause permanent damage to the power supply. These are stress ratings only and functional operation of the unit is not implied at these or any other conditions above those given in the operational sections of this TRN. Exposure to any absolute maximum rated condition for extended periods may adversely affect the power supply’s reliability.

Parameter	Model	Symbol	Min	Typ	Max	Unit
Input Voltage (DC continuous operation)	All models	V_{IN}	-	-	15	V
Operating Ambient Temperature ¹	All models	T_A	-40	-	+85	°C
Storage Temperature	All models	T_{STG}	-40	-	+125	°C
Output Voltage	All models	V_{OUT}	0.5	-	5.0	V
Logic I/O Voltage SHARE, EN1, EN2, PG1, PG2, SALRT, SCL, SDA, SYNC, VSET0, VSET1, CFG, ADDR, ASCRCFG	All models		-0.3	-	6.0	V
Analog Input Voltages VS1+, VS1-, VS2+, VS2-	All models		-0.3	-	6.5	V

Note 1 - At low temperatures, (at < -20°C), the accuracy of PMBus™ monitored parameters will be adversely affected. At high temperatures, please refer to “Thermal Derating” section.

ELECTRICAL SPECIFICATIONS

Input Specifications

Table 2. Input Specifications						
Parameter	Condition ¹	Symbol	Min	Nom	Max	Unit
Operating Input Voltage, DC	$0.5 \leq V_O \leq 3.3V$ $3.3 < V_O \leq 5V$	V_{IN}	7.5 10	- -	14 14	V V
Maximum Input Current	$V_{IN}=7.5V_{dc}$ $V_O = 3.3V$ $I_O = 80A$	$I_{IN,max}$	-	-	40	A
Standby Input Current ($V_O = \text{Off}$, $I_O = 0 A$)		I_{IN}	-	45	50	mA
Standby Input Power ($V_O = \text{Off}$, $I_O = 0 A$)		P_{IN}	-	0.54	0.60	W
Standby Input Power ($V_O = \text{On}$, $I_O = 0 A$)		P_{IN}	-	TBD	-	W
Efficiency at 12 V & 25°C	1.0V at 110A 1.8V at 100A 2.5V at 90A 3.3V at 80A 5.0V at 70A		87.5 91.5 93.0 94.0 95.0	88.5 92.5 94.0 95.0 96.0	- - - - -	%
Input Capacitor (Internal)			-	140	-	uF
Input Capacitor (External required) ²			-	88	-	uF
Input Voltage UVLO Threshold Range ³	Falling		6.5	6.9	-	V
Input Voltage UVLO Threshold Range ³	Rising		-	7.3	7.5	V
Logic Input/Output Characteristics						
Logic Input Low, VIL			-	-	0.8	V
Logic Input High, VIH			2	-	-	V
Logic Output Low, VOL	2mA sinking		-	-	0.5	V
Logic Output High, VOH	2mA sourcing		2.25	-	-	V
Logic Input Leakage Current			-100	-	100	nA

Note 1 - Typical values given at $V_{IN}=12V$, switching frequency = 533kHz for $0.5V \leq V_O \leq 5V$, $T_A = 25^\circ C$, unless otherwise specified under conditions.

Note 2 - Minimum: 4 x 22uF/16V 0805 ceramic cap (C2012X6S1C226M125AC or equivalent)

Note 3 - For 5V V_O configuration, it will use PMBus to set UVLO (Falling) to 8.9V and UVLO (Rising) to 9.2V.

ELECTRICAL SPECIFICATIONS

Output Specifications

Table 3. Output Specifications						
Parameter	Condition	Symbol	Min	Nom	Max	Unit
Output Voltage	$V_{IN} = 7.5V$ to $14V$	V_{O1}, V_{O2}	0.5	-	3.3	Vdc
	$V_{IN} = 10V$ to $14V$	V_{O1}, V_{O2}^1	0.5	-	5.0	Vdc
Output Current (Independent Output 1 and 2)	V_{O1} or $V_{O2} = 0.5V$	I_{O1}, I_{O2}	0	-	55	A
	V_{O1} or $V_{O2} = 1.0V$		0	-	55	A
	V_{O1} or $V_{O2} = 1.8V$		0	-	50	A
	V_{O1} or $V_{O2} = 2.5V$		0	-	45	A
	V_{O1} or $V_{O2} = 3.3V$		0	-	40	A
	V_{O1} or $V_{O2} = 5.0V$		0	-	35	A
Combined output 1 and 2	$V_O = 0.5V$	I_O	0	-	110	A
	$V_O = 1.0V$		0	-	110	A
	$V_O = 1.8V$		0	-	100	A
	$V_O = 2.5V$		0	-	90	A
	$V_O = 3.3V$		0	-	80	A
	$V_O = 5.0V$		0	-	70	A
Output Power	All	P_O	-	-	350	W
Output Set-point Accuracy ²	Set by PMBus™ or trim resistors		-1.0	-	+1.0	%
Output Voltage Set-point Resolution	Set by PMBus™ command	V_O	-0.025	-	+0.025	%
Output Voltage Positive Sensing Bias Current	VS [0,1] + = 4V (negative = sinking)		-100	-	100	μA
Output Voltage Negative Sensing Bias Current	VS [0,1] - = 0V		-20	-	20	μA
Line Regulation	$0.5V \leq V_O \leq 1.0V$		-	2	10	mV
	$1.0V < V_O \leq 5.0V$		-	0.2	1	%
Load Regulation	$0.5V \leq V_O \leq 1.0V$		-	5	10	mV
	$1.0V < V_O \leq 5.0V$		-	0.5	1	%
Ripple and Noise (with recommended caps) Single Output	$0.5V \leq V_O \leq 1.0V$		-	10	20	mV _{pk-pk}
	$1.0V < V_O \leq 5.0V$		-	1	2	% _{pk-pk}
Ripple and Noise (with recommended caps) Dual outputs(V_{O1}, V_{O2})	$0.5V \leq V_O \leq 1.0V$		-	10	20	mV _{pk-pk}
	$1.0V < V_O \leq 5.0V$		-	1	1	% _{pk-pk}
Transient Response Deviation (Independent Output 1 and 2)	50% of I_O step load, slew rate = 1A/us		-	-	-	-
	$0.5V \leq V_O \leq 1.0V$		-	50	60	mV _{pk-pk}
	$1.0V < V_O \leq 5.0V$		-	3	4	% _{pk-pk}
Transient Response Deviation (Combined output 1 and 2)	50% of I_O step load, slew rate = 1A/us		-	-	-	-
	$0.5V \leq V_O \leq 1.0V$		-	30	40	mV _{pk-pk}
	$1.0V < V_O \leq 5.0V$		-	3	4	% _{pk-pk}
Output Capacitor per Output (external minimum) ³	Dual outputs	C_O	-	1990	-	μF
	Single output	C_O	-	3980	-	μF

ELECTRICAL SPECIFICATIONS

Output Specifications

Table 3. Output Specifications con't						
Parameter	Condition	Symbol	Min	Nom	Max	Unit
Switching Frequency ⁴	$0.5V \leq V_O \leq 5.0V$	f_{sw}	-	533	800	KHz
PMBus™ Clock Frequency ⁵			100	-	400	KHz
Ton Delay/Toff Delay			-	5	-	mS
Ton Delay/Toff Delay Range	Set by PMBus™ command		0	-	5000	mS
Ton Delay/Toff Delay Accuracy	Turn on delay Turn off delay		-1 0	- -	1 1	mS
Ton Ramp/Toff Ramp Duration	Set by PMBus™ command		0	-	100	mS
Ton Ramp/Toff Ramp Duration Accuracy			-250	-	250	uS
Power Good Vo Threshold			85	90	95	%
Power Good Vo Hysteresis			-	5	10	%
Power-good Delay Applies to turn-on only (Low to High transition)	Factory Default Set using PMBus™		- 0	1 -	2 500	mS mS
Power Good Low Voltage	V_{IN} from 0-14V		-	-	0.5	V
MTBF	Calculated according to Telcordia SR-332 Issue 4 at 50% Electrical stress and 40°C components ambient temperature		20	-	-	MHours
Over Voltage Protection	All		-	110	-	% V_O
Over Current Protection ⁶	I_{O1}, I_{O2}		-	65	-	A
Over Temperature Protection	All		-	110	125	°C

Note 1 - Vo1 and Vo2 are the outputs of dual output module.

Note 2 - V_O measured at the termination of the VSx+ and VSx- sense points across line, load, temperature variation.

Note 3 - Dual mode (2 outputs): 2 x 680uF/6.3V Polymer Tan caps (T530X687M006ATE010 or equivalent)

+ 6 x 100uF/6.3V X6S 1210 ceramic caps (GRM32EC80J107ME20L or equivalent)

+ 3 x 10uF/16V X6S 0603 ceramic caps (GRM188C81C106MA73 or equivalent)

Single mode (1 output): 4 x 680uF/6.3V Polymer Tan caps (T530X687M006ATE010 or equivalent)

+ 12 x 100uF/6.3V X6S 1210 ceramic caps (GRM32EC80J107ME20L or equivalent)

+ 6 x 10uF/16V X6S 0603 ceramic caps (GRM188C81C106MA73 or equivalent)

Note 4 - For dual outputs condition, the switching frequency of both outputs must be the same.

Note 5 - For operation PMBus™ clock frequency at 400kHz, see PMBus™ Power System Management Protocol Specification for timing parameter limits.

Note 6 - The OCP set point applies per phase. The total OCP current value will be twice of I_{O1} in single mode. Please refer to Table 10 for OCP setting.

ELECTRICAL SPECIFICATIONS

LGA110D-01DADJJB Performance Curves

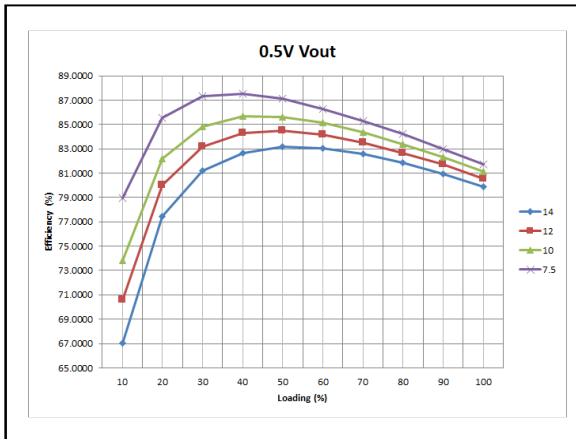

Figure 1: LGA110D-00DADJJB Efficiency Curves at different V_{IN} @ 25°C
Loading: I_O = 10% increment to 110A, V_O = 0.5V Frequency=533KHz

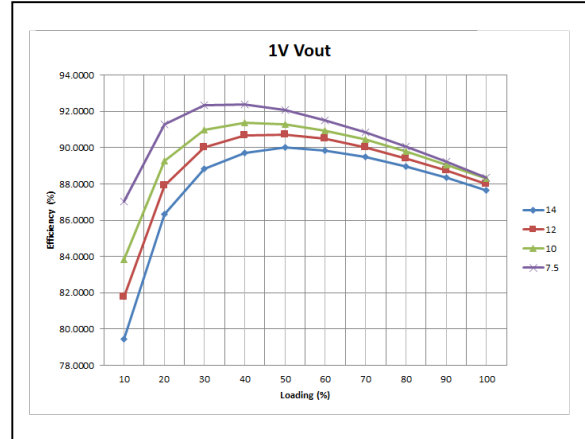

Figure 2: LGA110D-01DADJJB Efficiency Curves at different V_{IN} @ 25°C
Loading: I_O = 10% increment to 110A, V_O = 1V Frequency=533KHz

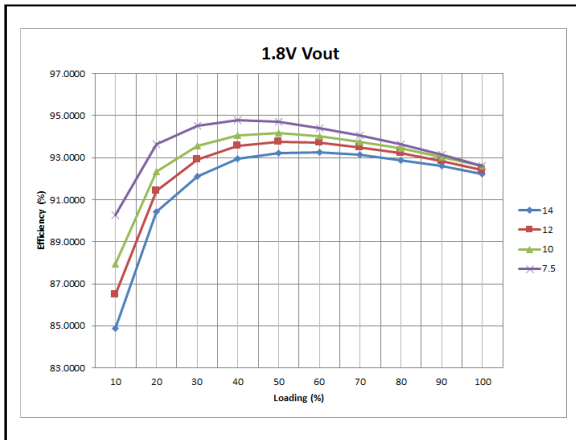

Figure 3: LGA110D-01DADJJB Efficiency Curves at different V_{IN} @ 25°C
Loading: I_O = 10% increment to 100A, V_O = 1.8V Frequency=533KHz

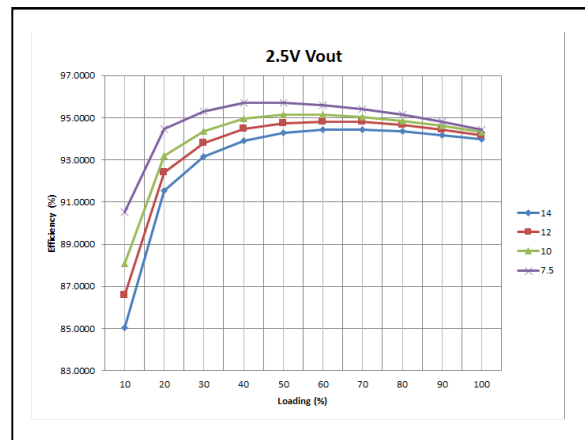

Figure 4: LGA110D-01DADJJB Efficiency Curves at different V_{IN} @ 25°C
Loading: I_O = 10% increment to 90A, V_O = 2.5V Frequency=533KHz

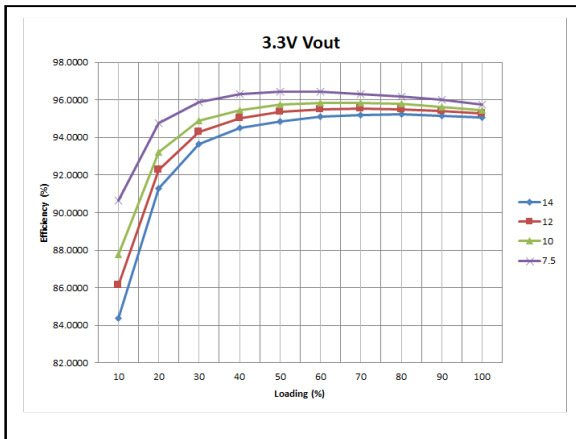

Figure 5: LGA110D-01DADJJB Efficiency Curves at different V_{IN} @ 25°C
Loading: I_O = 10% increment to 80A, V_O = 3.3V Frequency=533KHz

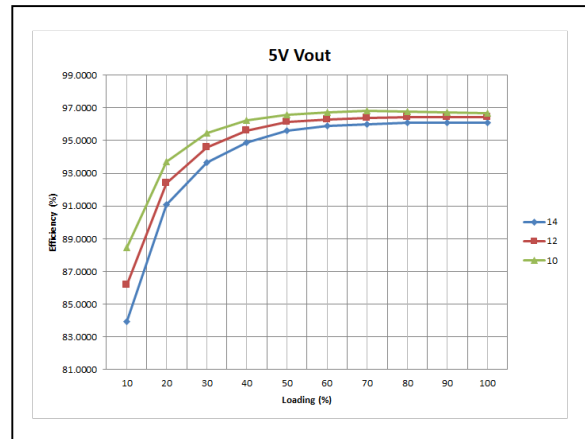

Figure 6: LGA110D-00DADJJB Efficiency Curves at different V_{IN} @ 25°C
Loading: I_O = 10% increment to 70A, V_O = 5V Frequency=533KHz

ELECTRICAL SPECIFICATIONS

LGA110D-01DADJJB Performance Curves (Efficiency at different switching frequency)

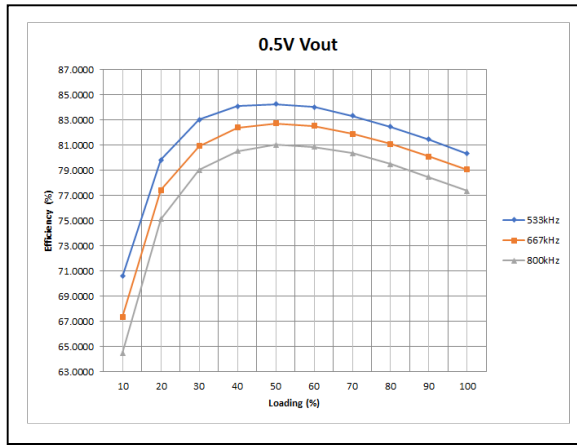

Figure 7: LGA110D-01DADJJB Efficiency Curves at different switching frequency @ 25°C, Vin = 12V
Loading: I_o = 10% increment to 110A

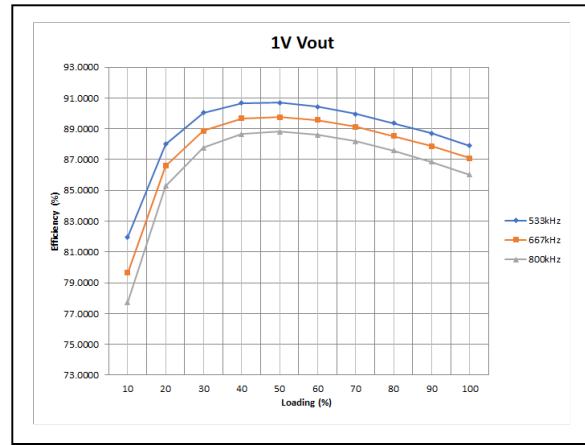

Figure 8: LGA110D-01DADJJB Efficiency Curves at different switching frequency @ 25°C, Vin = 12V
Loading: I_o = 10% increment to 110A

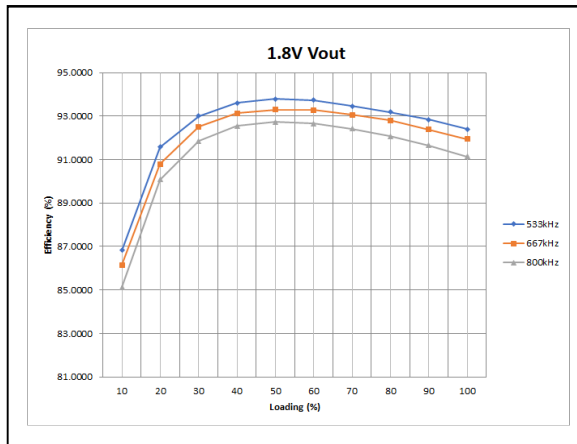

Figure 9: LGA110D-01DADJJB Efficiency Curves at different switching frequency @ 25°C, Vin = 12V
Loading: I_o = 10% increment to 100A

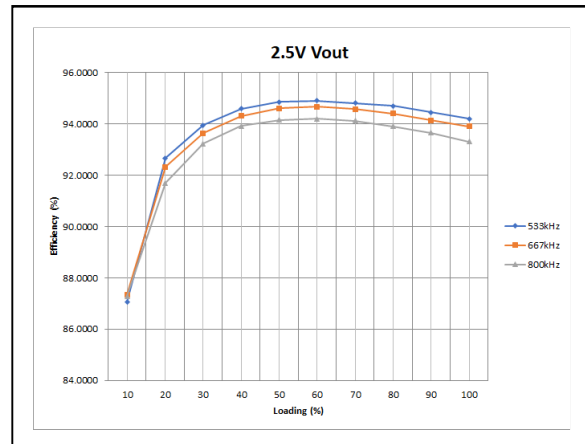

Figure 10: LGA110D-01DADJJB Efficiency Curves at different switching frequency @ 25°C, Vin = 12V
Loading: I_o = 10% increment to 90A



Figure 11: LGA110D-01DADJJB Efficiency Curves at different switching frequency @ 25°C, Vin = 12V
Loading: I_o = 10% increment to 80A

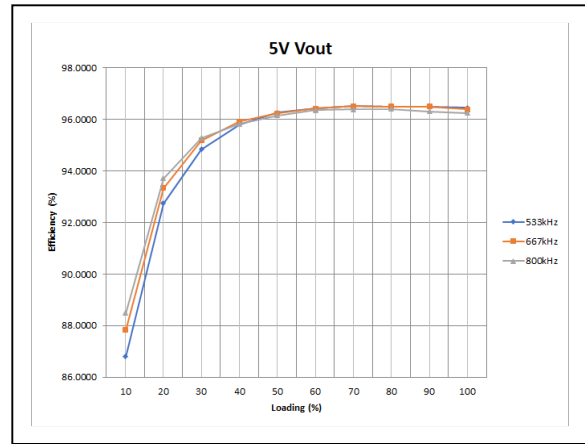

Figure 12: LGA110D-01DADJJB Efficiency Curves at different switching frequency @ 25°C, Vin = 12V
Loading: I_o = 10% increment to 70A

ELECTRICAL SPECIFICATIONS

LGA110D-01DADJJB Performance Curves (Thermal Derating)

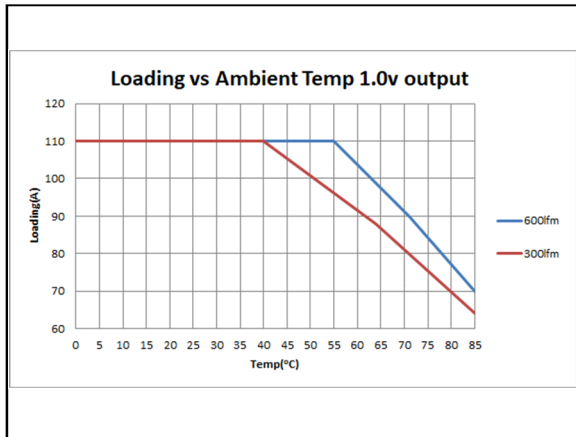

Figure 13: LGA110D-01DADJJB Thermal Derating Curves (Two modules with longitudinal airflow)
 Vin = 14V Load: I_O = 64 to 110A, V_O = 1.0V F_{SW} = 533kHz

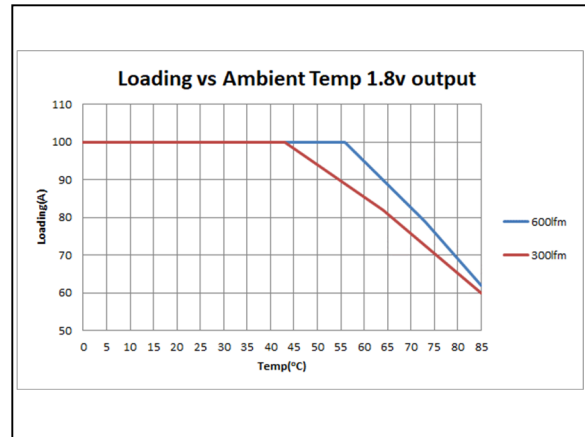

Figure 14: LGA110D-01DADJJB Thermal Derating Curves (Two modules with longitudinal airflow)
 Vin = 14V Load: I_O = 60 to 100A, V_O = 1.8V F_{SW} = 533kHz

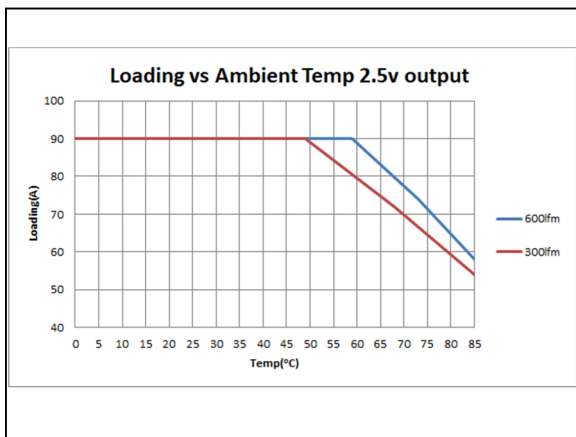

Figure 15: LGA110D-01DADJJB Thermal Derating Curves (Two modules with Longitudinal airflow)
 Vin = 14V Load: I_O = 54 to 90A, V_O = 2.5V F_{SW} = 533kHz

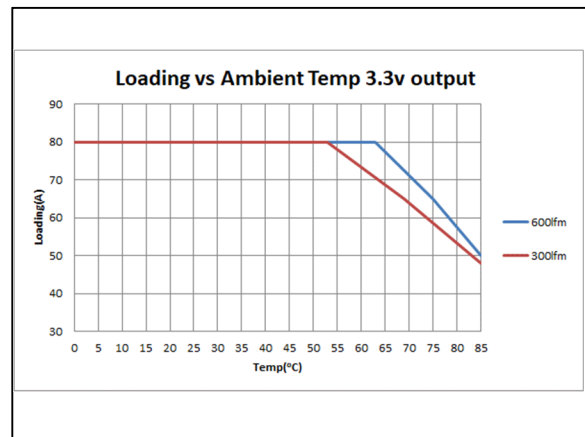

Figure 16: LGA110D-01DADJJB Thermal Derating Curves (Two modules with Longitudinal airflow)
 Vin = 14V Load: I_O = 48 to 80A, V_O = 3.3V F_{SW} = 533kHz

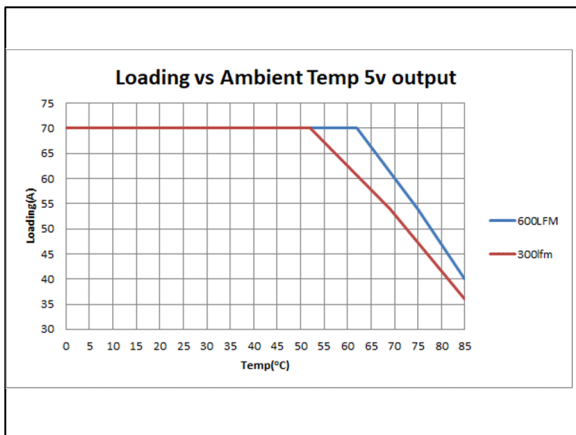

Figure 17: LGA110D-01DADJJB Thermal Derating Curves (Two modules with Longitudinal airflow)
 Vin = 14V Load: I_O = 36 to 70A, V_O = 5.0V F_{SW} = 533kHz

Note: One module temperature is much better than two modules.

ELECTRICAL SPECIFICATIONS

LGA110D-01DADJJB Performance Curves (Ripple and Noise)

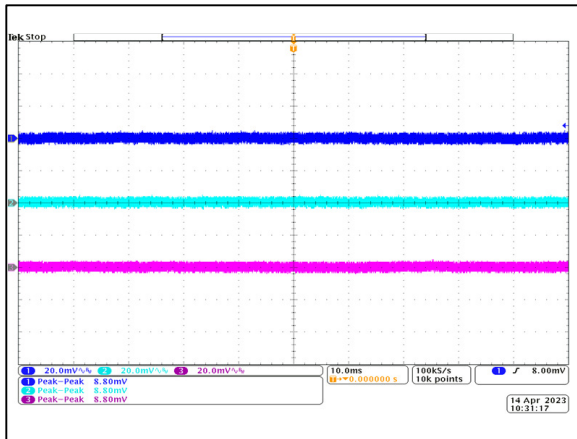

Figure 18: LGA110D-01DADJJB Ripple and Noise - $V_o = 0.5V$
Full Load
Ch 1: V_{O1} Ch 2: V_{O2} Ch 3: V_{O3}

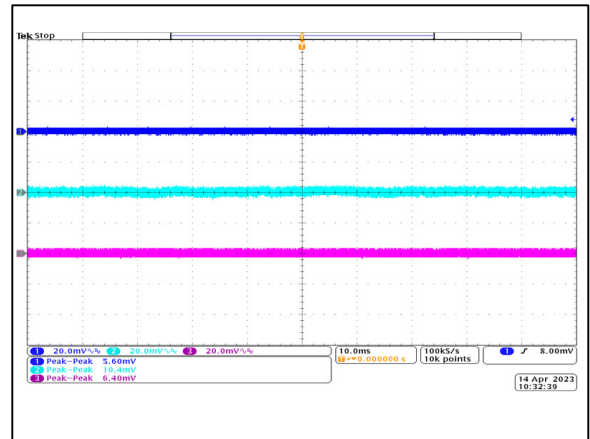

Figure 19: LGA110D-01DADJJB Ripple and Noise - $V_o = 1.0V$
Full Load
Ch 1: V_{O1} Ch 2: V_{O2} Ch 3: V_{O3}

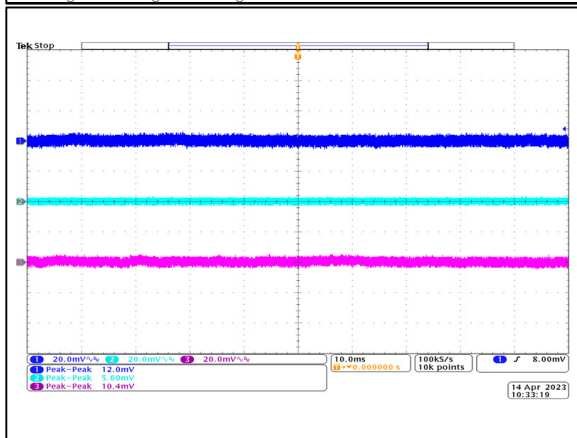

Figure 20: LGA110D-01DADJJB Ripple and Noise - $V_o = 1.8V$
Full Load
Ch 1: V_{O1} Ch 2: V_{O2} Ch 3: V_{O3}

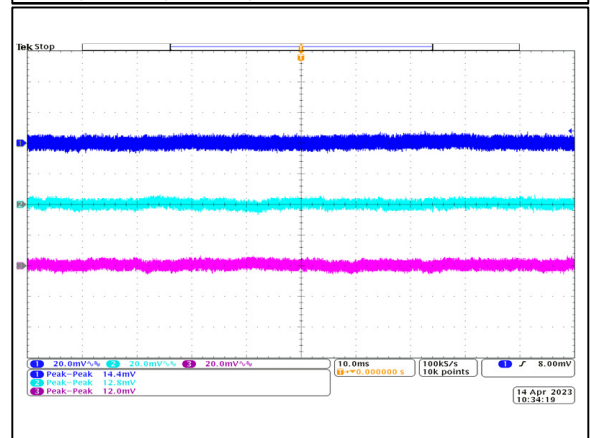

Figure 21: LGA110D-01DADJJB Ripple and Noise - $V_o = 2.5V$
Full Load
Ch 1: V_{O1} Ch 2: V_{O2} Ch 3: V_{O3}

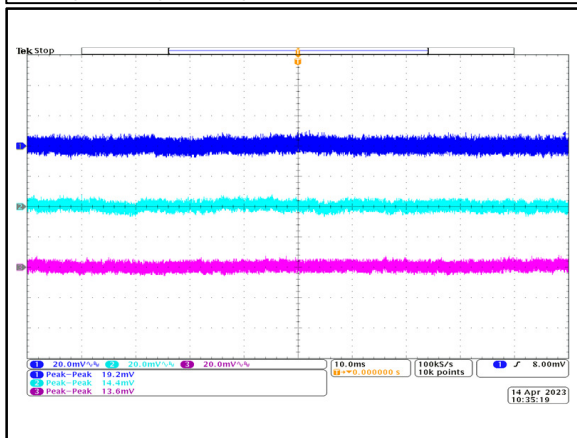

Figure 22: LGA110D-01DADJJB Ripple and Noise - $V_o = 3.3V$
Full Load
Ch 1: V_{O1} Ch 2: V_{O2} Ch 3: V_{O3}

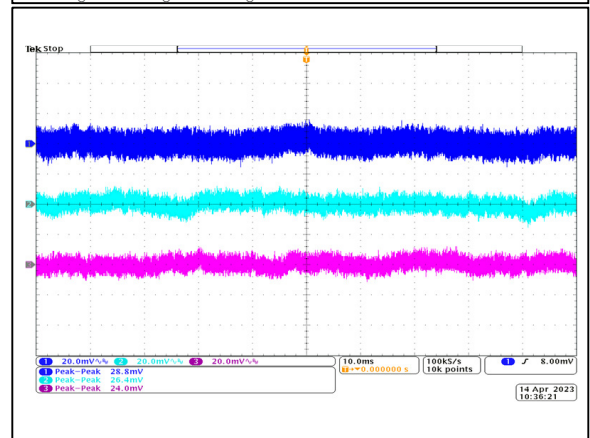

Figure 23: LGA110D-01DADJJB Ripple and Noise - $V_o = 5.0V$
Full Load
Ch 1: V_{O1} Ch 2: V_{O2} Ch 3: V_{O3}

Note: V_{O1} and V_{O2} are the outputs of dual output module, V_{O3} is the output of single output module.

ELECTRICAL SPECIFICATIONS

LGA110D-01DADJJB Performance Curves (Start Up)

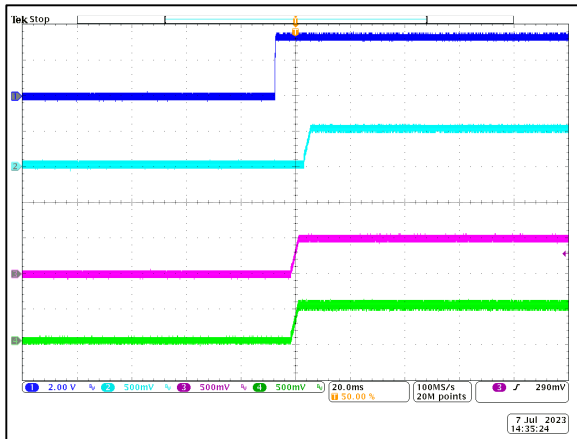

Figure 24: LGA110D-01DADJJB Start Up - $V_o = 0.5V$
Full Load
Ch 1: Enable Ch 2: V_{O1} Ch 3: V_{O2} Ch 4: V_{O3}

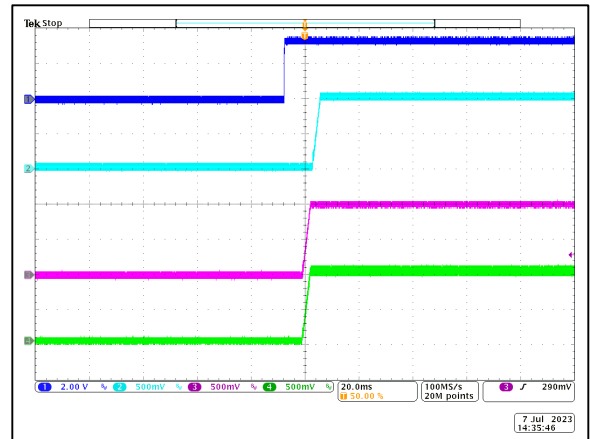

Figure 25: LGA110D-01DADJJB Start Up - $V_o = 1V$
Full Load
Ch 1: Enable Ch 2: V_{O1} Ch 3: V_{O2} Ch 4: V_{O3}

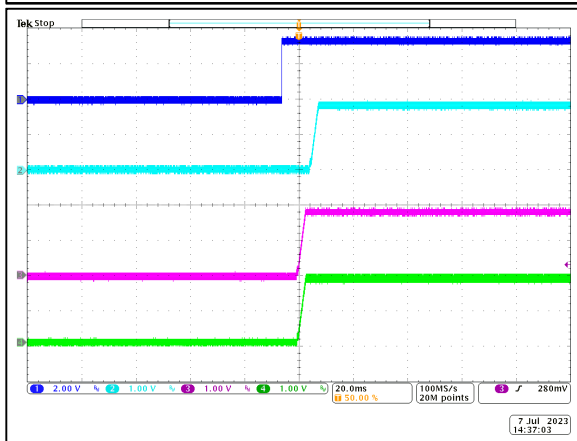

Figure 26: LGA110D-01DADJJB Start Up - $V_o = 1.8V$
Full Load
Ch 1: Enable Ch 2: V_{O1} Ch 3: V_{O2} Ch 4: V_{O3}

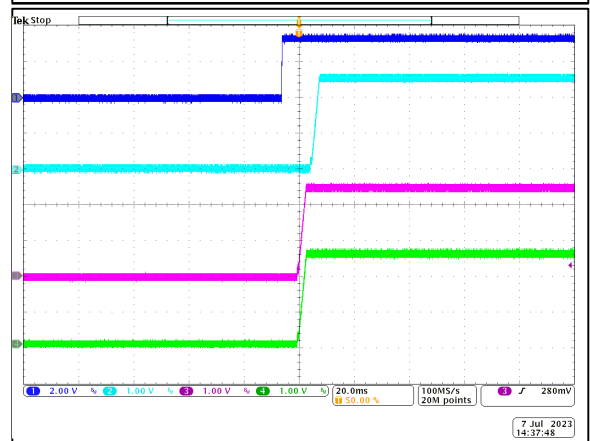

Figure 27: LGA110D-01DADJJB Start Up - $V_o = 2.5V$
Full Load
Ch 1: Enable Ch 2: V_{O1} Ch 3: V_{O2} Ch 4: V_{O3}

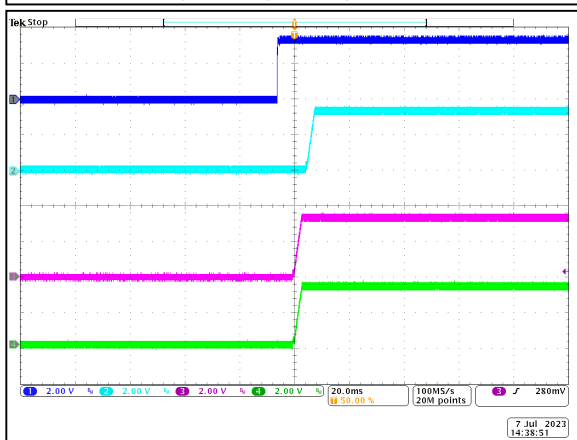

Figure 28: LGA110D-01DADJJB Start Up - $V_o = 3.3V$
Full Load
Ch 1: Enable Ch 2: V_{O1} Ch 3: V_{O2} Ch 4: V_{O3}

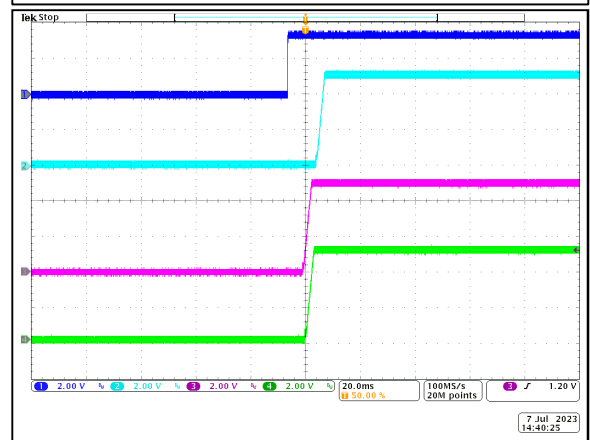

Figure 29: LGA110D-01DADJJB Start Up - $V_o = 5.0V$
Full Load
Ch 1: Enable Ch 2: V_{O1} Ch 3: V_{O2} Ch 4: V_{O3}

Note: V_{O1} and V_{O2} are the outputs of dual output module, V_{O3} is the output of single output module.

ELECTRICAL SPECIFICATIONS

LGA110D-01DADJJB Performance Curves (Slow Dynamic Load Response – 2 phase 2 output)

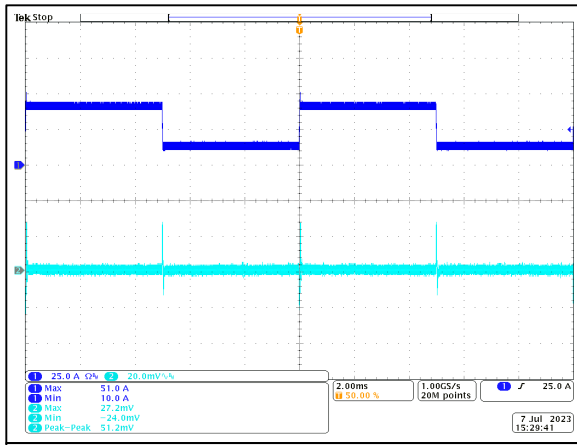

Figure 30: LGA110D-01DADJJB Transient Response - Vo Deviation
25% to 75% to 25% load change, 1A/ μ S slew rate, Vin = 12Vdc Vo = 0.5V
Ch 1: Io Ch 2: Vo F_{SW}=533kHz

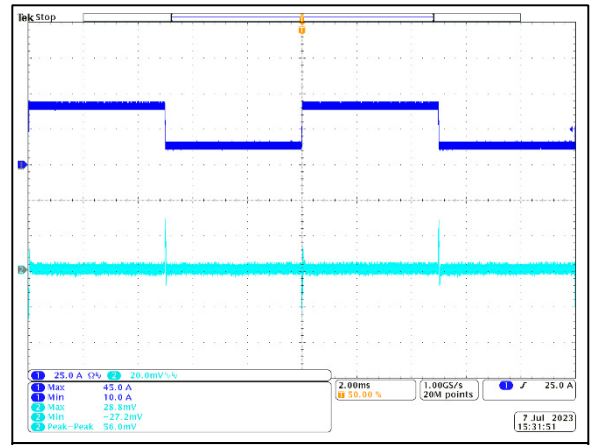

Figure 31: LGA110D-01DADJJB Transient Response - Vo Deviation
25% to 75% to 25% load change, 1A/ μ S slew rate, Vin = 12Vdc Vo = 1.0V
Ch 1: Io Ch 2: Vo F_{SW}=533kHz

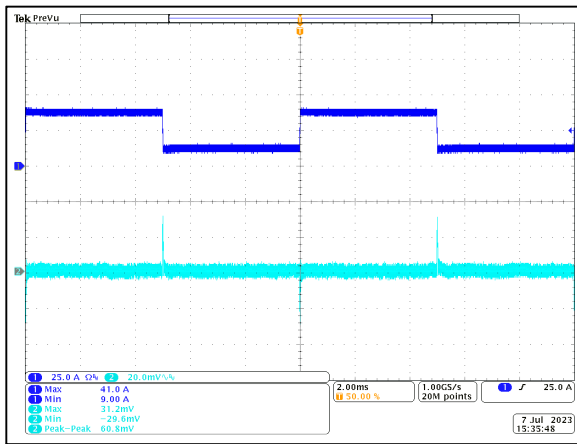

Figure 32: LGA110D-01DADJJB Transient Response - Vo Deviation
25% to 75% to 25% load change, 1A/ μ S slew rate, Vin = 12Vdc Vo = 1.8V
Ch 1: Io Ch 2: Vo F_{SW}=533kHz

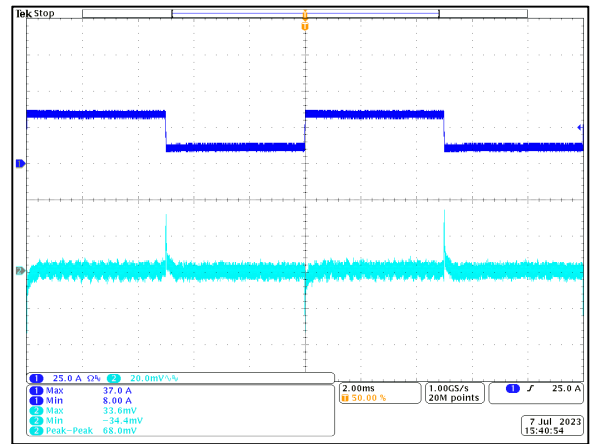

Figure 33: LGA110D-01DADJJB Transient Response - Vo Deviation
25% to 75% to 25% load change, 1A/ μ S slew rate, Vin = 12Vdc Vo = 2.5V
Ch 1: Io Ch 2: Vo F_{SW}=533kHz

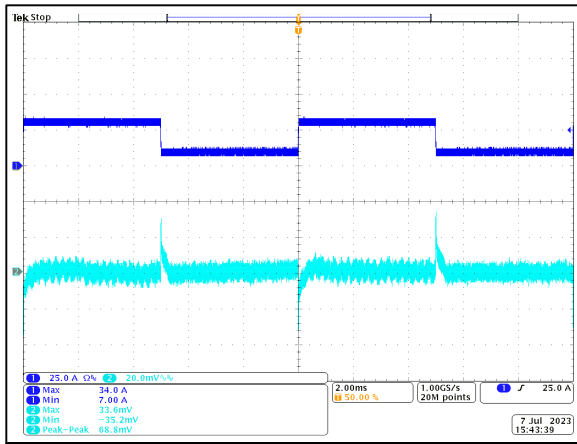

Figure 34: LGA110D-01DADJJB Transient Response - Vo Deviation
25% to 75% to 25% load change, 1A/ μ S slew rate, Vin = 12Vdc Vo = 3.3V
Ch 1: Io Ch 2: Vo F_{SW}=533kHz

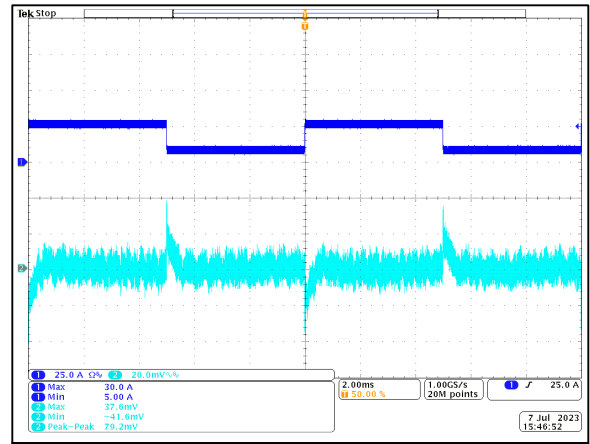

Figure 35: LGA110D-01DADJJB Transient Response - Vo Deviation
25% to 75% to 25% load change, 1A/ μ S slew rate, Vin = 12Vdc Vo = 5.0V
Ch 1: Io Ch 2: Vo F_{SW}=533kHz

ELECTRICAL SPECIFICATIONS

LGA110D-01DADJJ Performance Curves (Slow Dynamic Load Response – 2 phase 1 output)

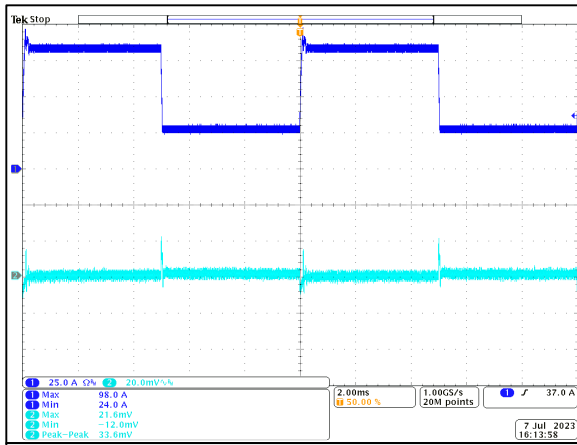

Figure 36: LGA110D-01DADJJ Transient Response - Vo Deviation
 25% to 75% to 25% load change, 1A/ μ S slew rate, Vin = 12Vdc Vo = 0.5V
 Ch 1: I_O Ch 2: V_O F_{SW} =533kHz

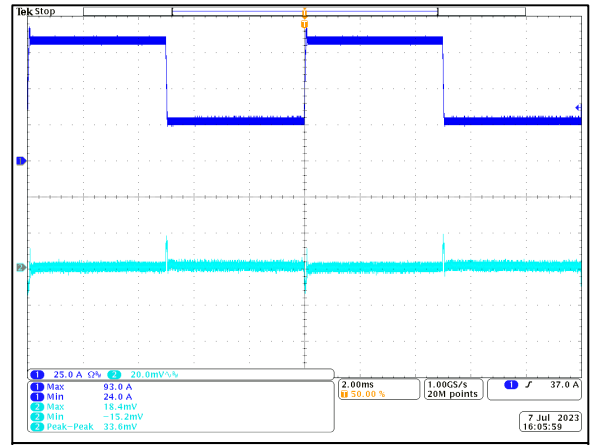

Figure 37: LGA110D-01DADJJ Transient Response - Vo Deviation
 25% to 75% to 25% load change, 1A/ μ S slew rate, Vin = 12Vdc Vo = 1.0V
 Ch 1: I_O Ch 2: V_O F_{SW} =533kHz

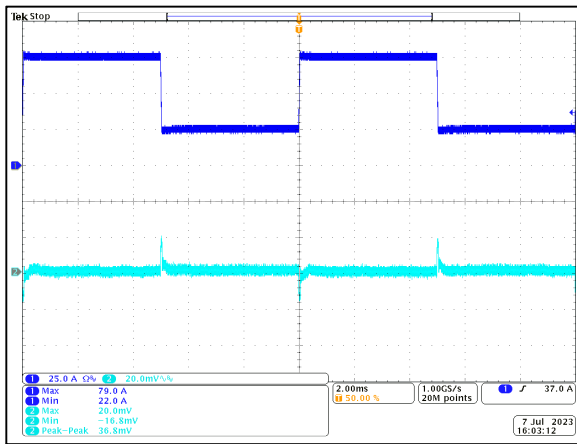

Figure 38: LGA110D-01DADJJ Transient Response - Vo Deviation
 25% to 75% to 25% load change, 1A/ μ S slew rate, Vin = 12Vdc Vo = 1.8V
 Ch 1: I_O Ch 2: V_O F_{SW} =533kHz

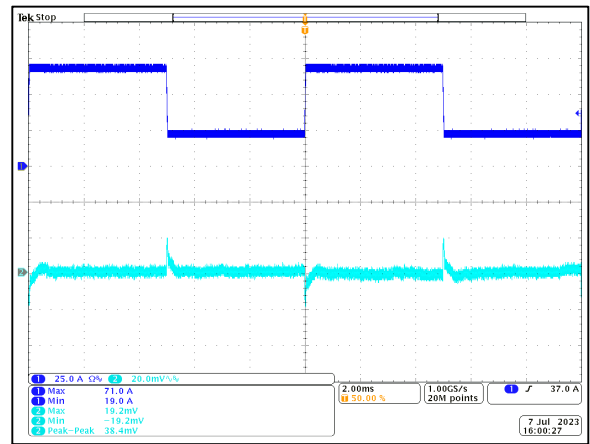

Figure 39: LGA110D-01DADJJ Transient Response - Vo Deviation
 25% to 75% to 25% load change, 1A/ μ S slew rate, Vin = 12Vdc Vo = 2.5V
 Ch 1: I_O Ch 2: V_O F_{SW} =533kHz

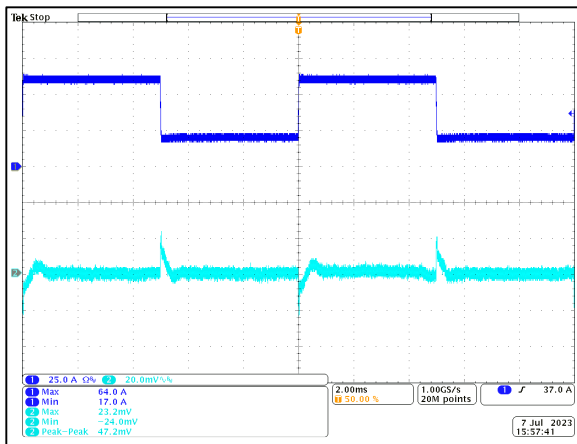

Figure 40: LGA110D-01DADJJ Transient Response - Vo Deviation
 25% to 75% to 25% load change, 1A/ μ S slew rate, Vin = 12Vdc Vo = 3.3V
 Ch 1: I_O Ch 2: V_O F_{SW} =533kHz

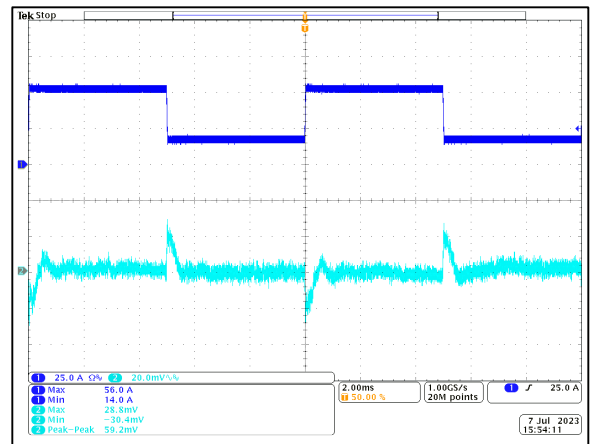
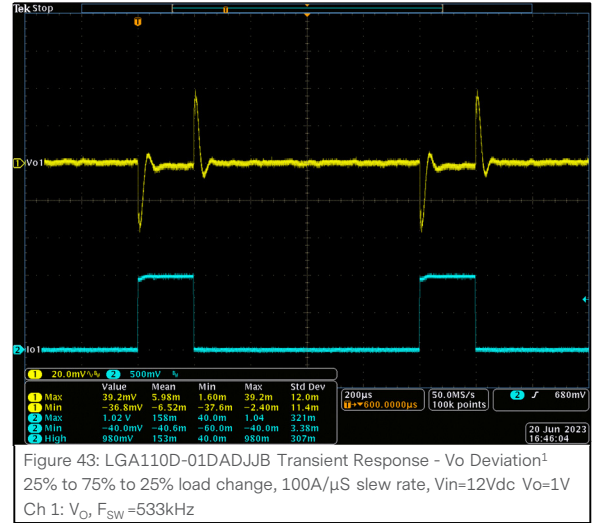
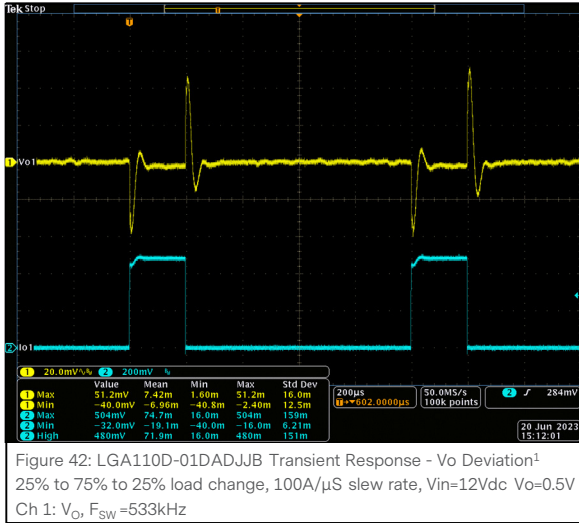

Figure 41: LGA110D-01DADJJ Transient Response - Vo Deviation
 25% to 75% to 25% load change, 1A/ μ S slew rate, Vin = 12Vdc Vo = 5.0V
 Ch 1: I_O Ch 2: V_O F_{SW} =533kHz

ELECTRICAL SPECIFICATIONS

LGA110D-01DADJJB Performance Curves (Fast Dynamic Load Response – 2 phase 2 output)



LGA110D-01DADJJ Performance Curves (Fast Dynamic Load Response – 2 phase 1 output)

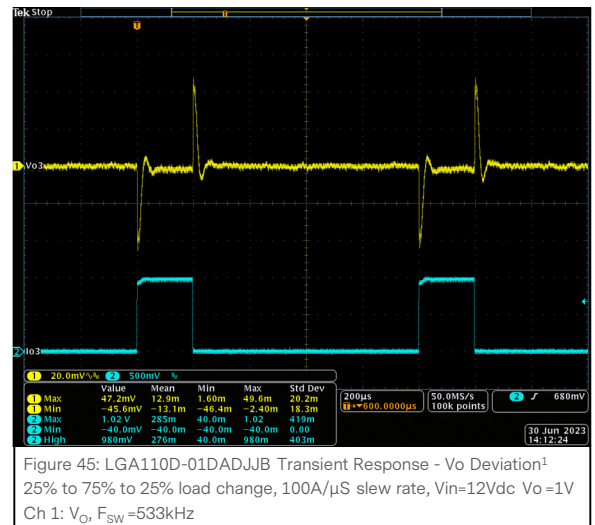
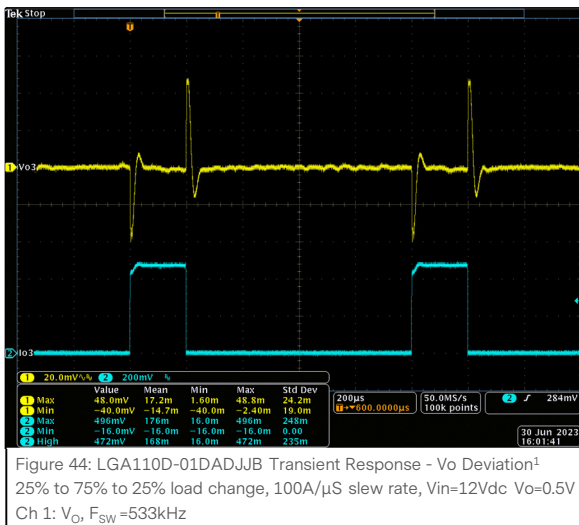

Note 1: ASCR gain 200. Recommended output cap “2 x 680 μF/6.3 V Polymer Tan caps + 8 x 100 μF/6.3 V ceramic caps + 3 x 10 μF/6.3 V ceramic caps.

PROTECTION SPECIFICATIONS

Output Overvoltage Protection

The LGA110D offers an internal output overvoltage protection circuit that can be used to protect sensitive load circuitry from being subjected to a voltage higher than its prescribed limits. A hardware comparator is used to compare the actual output voltage (seen at the VS pin) to a programmable threshold set to 10% higher than the target output voltage (the default setting).

If the VS voltage exceeds this threshold, the PG pin will de-assert and the module will latch.

Output Pre-Bias Protection

The LGA110D provides pre-biased start-up operation in 2 outputs and single module 2 phase operation. Pre-Bias protection is not provided when operating in current sharing 4, 6 or 8 phase configurations. An output pre-bias condition exists when an externally applied voltage is present on a power supply's output before the power supply's control IC is enabled. Certain applications require that the converter not be allowed to sink current during start up if a pre-bias condition exists at the output.

The LGA110D provides pre-bias protection by sampling the output voltage prior to initiating an output ramp.

If a pre-bias voltage lower than the desired output voltage is present after the Ton-delay time the LGA110D starts switching with a duty cycle that matches the pre-bias voltage. This ensures that the ramp-up from the pre-bias voltage is monotonic. The output voltage is then ramped to the desired output voltage at the ramp rate set by the TON_RISE command.

The resulting output voltage rise time will vary depending on the pre-bias voltage, but the total time elapsed from the end of the Ton-delay time to when the Ton-rise time is complete and the output is at the desired value will match the pre-configured ramp time. See Figure 46 and Figure 47.

If a pre-bias voltage higher than the target voltage exists after the pre-configured Ton-delay time and Ton-rise time have completed, the LGA110D starts switching with a duty cycle that matches the pre-bias voltage. This ensures that the ramp-down from the pre-bias voltage is monotonic. The output voltage is then ramped down to the desired output voltage.

If a pre-bias voltage higher than the overvoltage limit exists, the module will not initiate a turn-on sequence and will stay off with an output OV fault recorded.

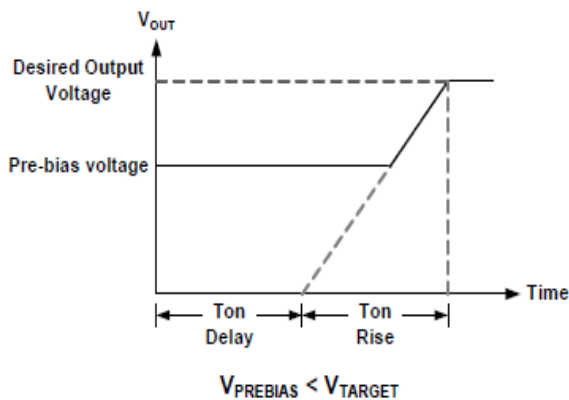

Figure 46

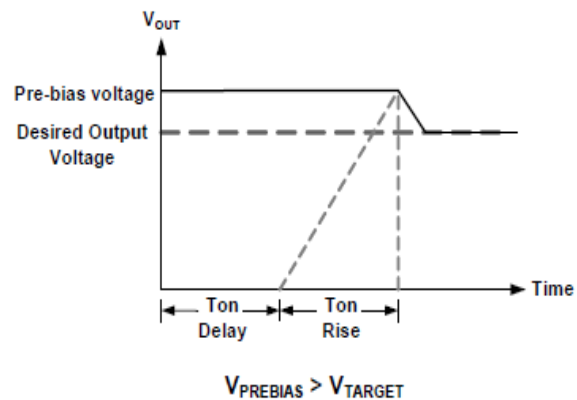

Figure 47

PROTECTION SPECIFICATIONS

Input Voltage Undervoltage Lock-Out Setting (UVLO)

The input undervoltage lockout (UVLO) prevents the LGA110D from operating when the input falls below a preset threshold, indicating the input supply is out of its specified range. The input voltage undervoltage lock-out threshold can be set between 0V and 16V using the VIN_UV_FAULT_LIMIT command. The default UVLO ON and OFF value are 7.3V and 6.9V respectively.

For 5Vout, it is recommended to use PMBus™ to set UVLO (Falling) to 8.9V and UVLO (Rising) to 9.2V.

However, there is no problem for operation without setting the recommended 5Vout UVLO.

The default response from an undervoltage fault is to shutdown and stay off until the fault has cleared and the module has been disabled and re-enabled.

When controlling the LGA110D exclusively through the PMBus™ a high voltage setting for UVLO can be used to prevent the LGA110D from being enabled until a lower voltage for UVLO is set using the VIN_UV_FAULT_LIMIT command.

Output Over Current Protection

The LGA110D can protect the power supply from damage from an overloaded or shorted output. Once the current trigger OCP set point, the unit will latch.

Over Temperature Protection

The LGA110D provide over temperature protection where the hotspot of the module. Once the module has been disabled due to over temperature fault, the unit will auto recovery once temperature is below typical +110°C of OT_WARN_LIMIT.

MECHANICAL SPECIFICATIONS

Mechanical Drawing (Dimensioning and Mounting Locations)

Side view of standard metal-block pin termination type (LGA110D-01DADJJB)

Maximum Weight = 11.4g

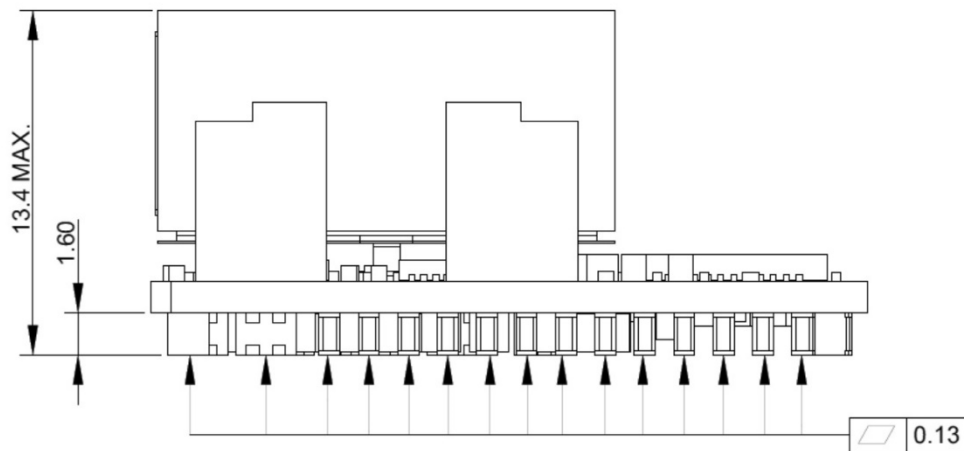

Notes: Dimensions are in millimeters
Tolerance: X.XXmm ± 0.25mm

MECHANICAL SPECIFICATIONS

Mechanical Drawing (Dimensioning and Mounting Locations)

Footprint Drawing of Metal Pins (Bottom View)

For standard metal-block pin termination (LGA110D-01DADJJB)

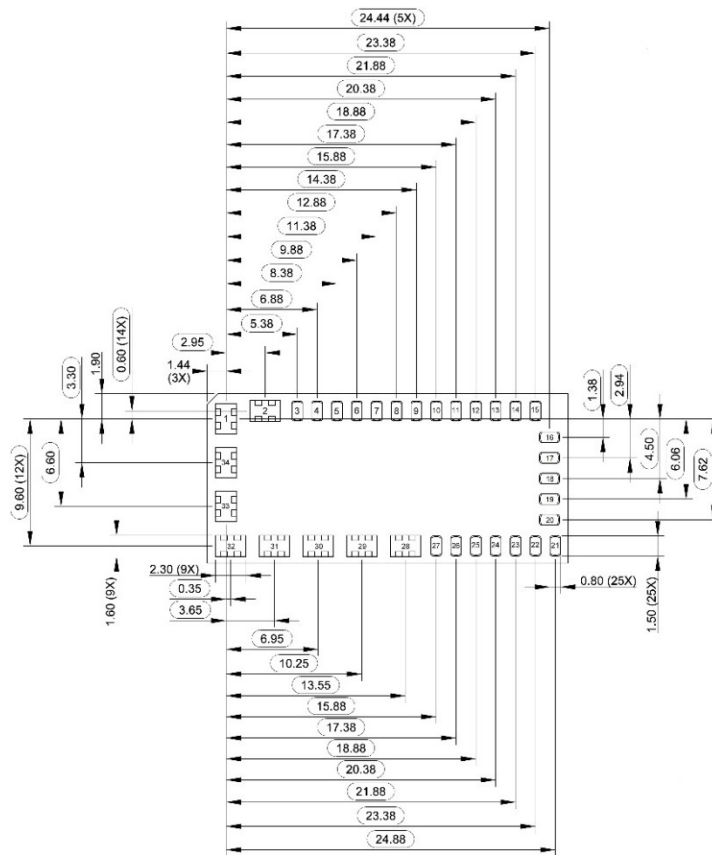

Notes: Dimensions are in millimeters
Tolerance: X.XXmm ± 0.25mm

Table 4. Pin Assignments:

Pin #	Function	Pin #	Function
1	VIN	18	SCL
2	GND	19	VTRIM2
3	CFG	20	SHARE
4	ASCRCFG	21	-
5	ADDR	22	VS1-
6	-	23	VS1+
7	VTRIM1	24	SYNC
8	-	25	PG2
9	SGND	26	VS2-
10	PG1	27	VS2+
11	EN1	28	Vo1
12	SALERT	29	Vo1
13	EN2	30	GND
14	SHARE	31	Vo2
15	-	32	Vo2
16	-	33	GND
17	SDA	34	VIN

MECHANICAL SPECIFICATIONS

Mechanical Drawing (Dimensioning and Mounting Locations)

Proposed solder pad macros for standard solder bump termination (LGA110D-01DADJJB). It's adopted for standard metal-block pin termination (LGA110D-01DADJJB).

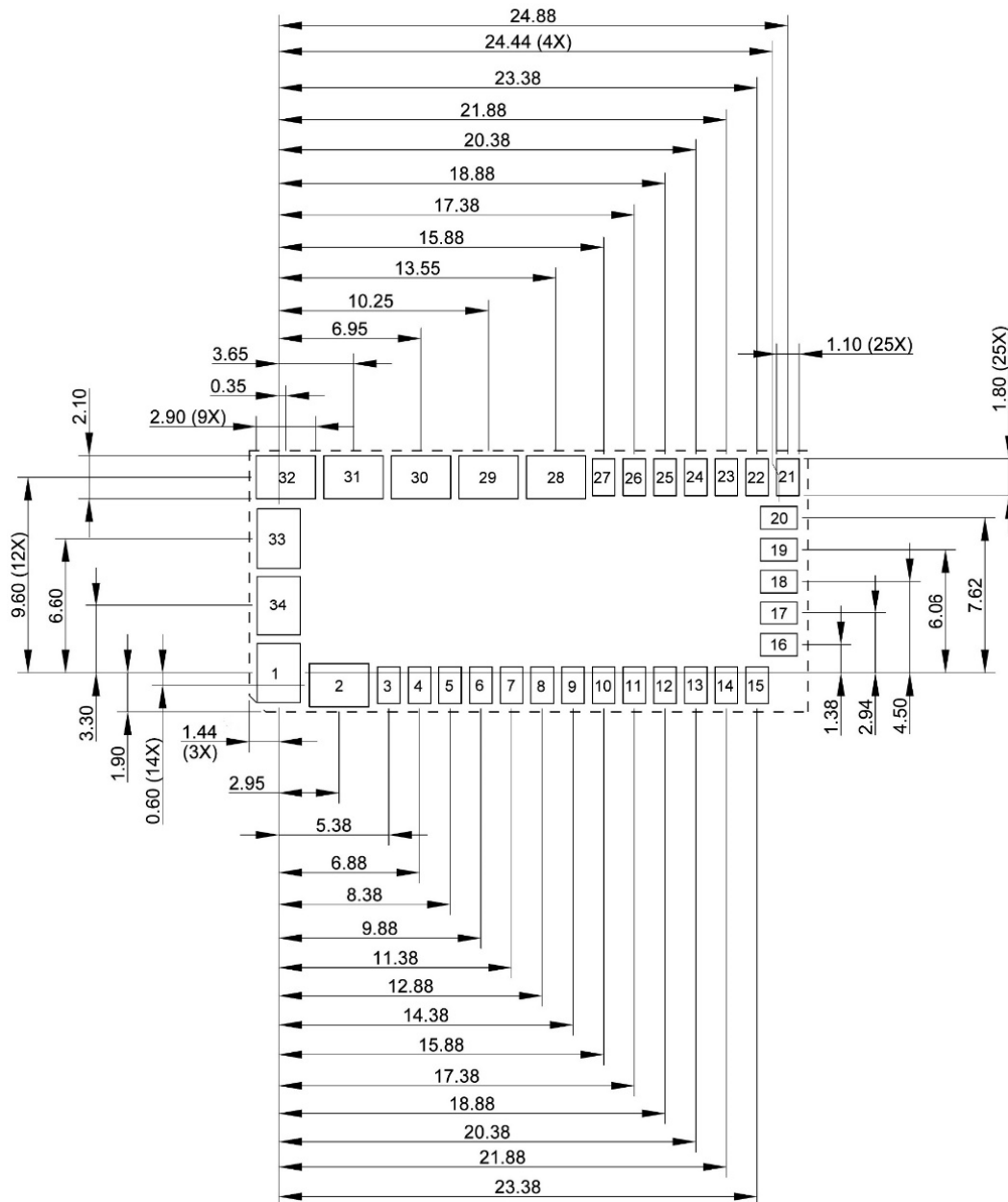

Notes: Dimensions are in millimeters
 Tolerance: X.XXmm ± 0.25mm
 Dot line represents LGA110D module outline

MECHANICAL SPECIFICATIONS

Mechanical Considerations

Surface Mount Tape & Reel

LGA110D-01DADJJB

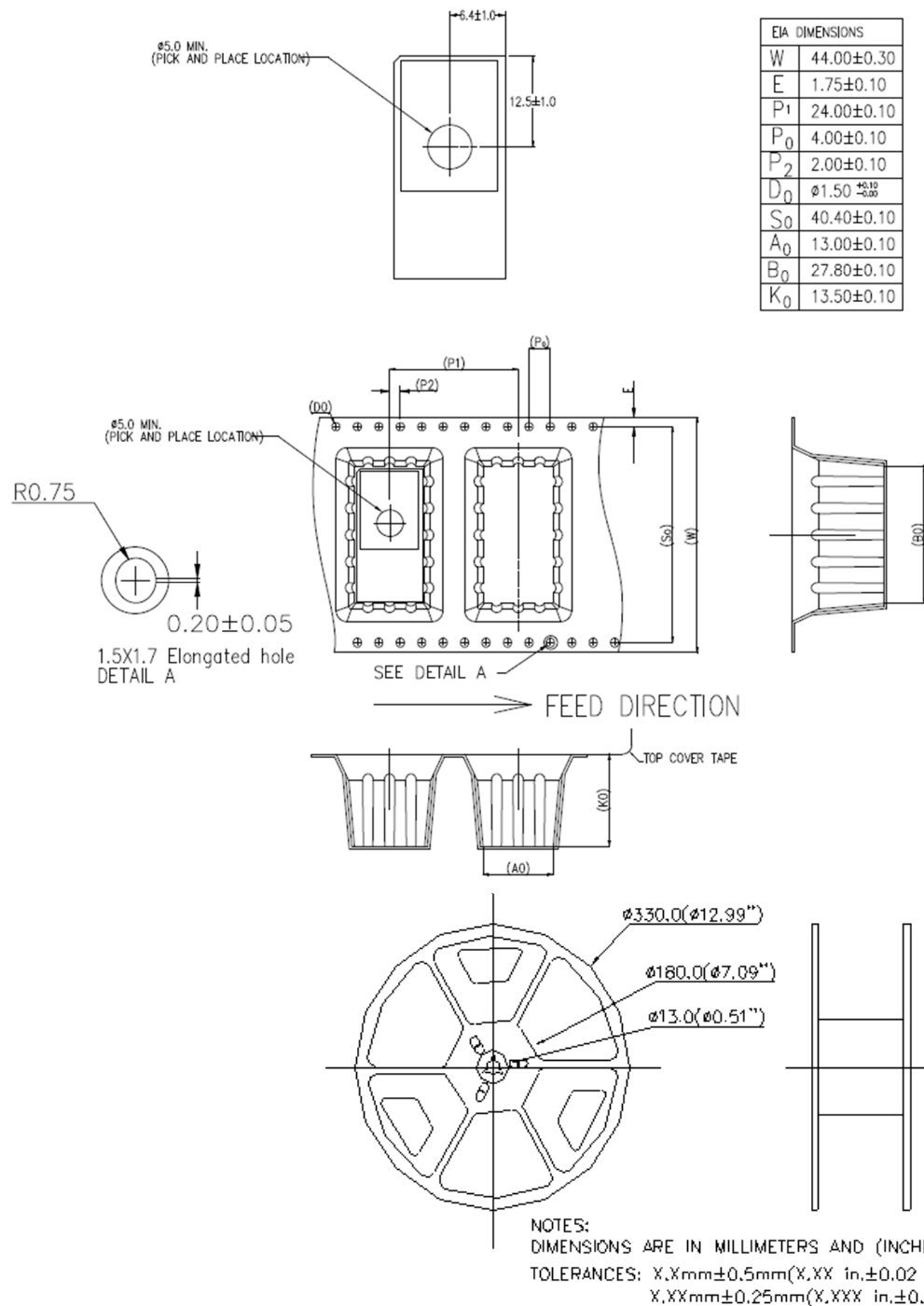

MECHANICAL SPECIFICATIONS

Power and Control Signal Descriptions

Table 6. Power and Control Signal Descriptions			
Pin #	Control Pin	Type ¹	Function
1	Vin	PWR	Input positive power pin.
2	GND	PWR	Power ground pin.
3	CFG	M	Setting current sense, current limit and operating mode. Refer to configuration setting.
4	ASCRCFG	M	Control loop configuration settings. Refer to control loop (ASCR) setting.
5	ADDR	M	Serial address select pin. Used to assign unique address for each individual device. Connect resistor to SGND. Refer to Address Setting.
6	-	NC	Not connected.
7	VTRIM1	M	Setting output voltage Vo1. Connect resistor to SGND. Refer to Output Voltage Setting.
8	-	NC	Not connected.
9	SGND	PWR	Signal ground. SGND is shorted to GND internally on LGA110D.
10	PG1	O	V _{O1} power-good output. Default is open drain.
11	EN1	I	Enable V _{O1} . Active signal enables.
12	SALERT	O	Serial alert. Connect to external host if desired. Requires a pull-up resistor to a 2.5V to 5.5V source, the source must be always on. 2.2Kohm pull-up resistor is recommended.
13	EN2	I	Enable V _{O2} . Active signal enables.
14	SHARE	I/O	Single-wire DDC bus for current sharing, inter - LGA110Ds communication. Pulled high to 5V by 10Kohm resistor and connected to pin 20 internally.
15	-	NC	Not connected.
16	-	NC	Not connected.
17	SDA	I/O	Serial data. Connect to external host and/or to other LGA110D. Requires a pull-up resistor to a 2.5V to 5.5V source, the source must be always on. 2.2Kohm pull-up resistor is recommended.
18	SCL	I/O	Serial clock. Connect to external host and/or to other LGA110D. Requires a pull-up resistor to a 2.5V to 5.5V source, the source must be always on. 2.2Kohm pull-up resistor is recommended.
19	VTRIM2	M	Setting output voltage Vo2. Connect resistor to SGND. Refer to Output Voltage Setting.
20	SHARE	I/O	Single-wire DDC bus for current sharing, inter- LGA110Ds communication. Pulled high to 5V by 10Kohm resistor and connected to pin14 internally.
21	-	NC	Not connected.
22	VS1-	I	Differential output V _{O1} voltage sense feedback. Connect to negative output regulation point.
23	VS1+	I	Differential output V _{O1} voltage sense feedback. Connect to positive output regulation point.
24	SYNC	M/I/O	Clock synchronization input. Used to set the switching frequency. Refer to Switching Frequency Setting
25	PG2	O	V _{O2} power-good output. Default is open drain.

Note 1 - I = Input, O = Output, PWR = Power or Ground, M = Multimode pins, NC = No connection

MECHANICAL SPECIFICATIONS

Table 6. Power and Control Signal Descriptions con't

Pin #	Function	Type ¹	Control Pin
26	VS2-	I	Differential output V _O 2 voltage sense feedback. Connect to negative output regulation point.
27	VS2+	I	Differential output V _O 2 voltage sense feedback. Connect to positive output regulation point.
28	V _O 1	PWR	Output V _O 1 positive power pin.
29	V _O 1	PWR	Output V _O 1 positive power pin.
30	GND	PWR	Power ground pin.
31	V _O 2	PWR	Output V _O 2 positive power pin.
32	V _O 2	PWR	Output V _O 2 positive power pin.
33	GND	PWR	Power ground pin.
34	Vin	PWR	Input positive power pin.

Note 1: I = Input, O = Output, PWR = Power or Ground, M = Multimode pins.

PMBus™ SPECIFICATIONS

LGA110D PMBus™ Interface Support

PMBus™ Communications

The LGA110D provides a SMBus digital interface. The LGA110D can be used with any standard 2-wire SMBus host module. In addition, the module is compatible with SMBus version 2.0 and includes an SALERT line to help mitigate bandwidth limitations related to continuous fault monitoring. Pull-up resistors are required on the SMBus. The pull-up resistor may be tied to an external 3.3V or 5V supply as long as this voltage is present prior to or during module power-up. The ideal design will use a central pull-up resistor that is well-matched to the total load capacitance. The minimum pull-up resistance should be limited to a value that enables any module to assert the bus to a voltage that will ensure a logic 0 (typically 0.8V at the module monitoring point) given the pull-up voltage is 5V and the pull-down current capability of the LGA110D. A pull-up resistor of 2.2Kohm is a good value for most applications.

SMBus Data and Clock lines should be routed with a closely coupled return or ground plane to minimize coupled interference (noise). Excessive noise on the data and clock lines that cause the voltage on these lines to cross the high and low logic thresholds of 2.0V and 0.8V respectively will cause command transmissions to be interrupted and result in slow bus operation or missed commands. For less than 10 modules on an SMBus a 2.2Kohm resistor on each line provides good performance.

The LGA110D accepts most standard PMBus™ commands. When enabling the module with ON_OFF_CONFIG command, it is recommended that the enable pin is tied to SGND.

In addition to bus noise considerations, it is important to ensure that user connections to the SMBus are compliant to the PMBus™ command standards. Any module that can malfunction in a way that permanently shorts SMBus lines will disable PMBus™ communications. Incomplete PMBus™ commands can also cause the LGA110D to halt PMBus™ communications. This can be corrected by disabling, then re-enabling the module. Highly recommend to have command validation after commands are set via PMBus communication.

Monitoring via PMBus™

A system controller can monitor a wide variety of different LGA110D parameters through the SMBus interface. The module can monitor for fault conditions by monitoring the SALERT pin, which will be asserted when any number of pre-configured fault conditions occur.

The module can also be monitored continuously for any number of power conversion parameters including but not limited to the following:

- Input voltage
- Output voltage
- Output current
- Internal junction temperature
- Fault status information

The PMBus™ Host should respond to SALERT as follows:

1. LGA110D module pulls SALERT Low.
2. PMBus™ Host detects that SALERT is now low, performs transmission with Alert Response Address to find which LGA110D module is pulling SALERT low.
3. PMBus™ Host talks to the LGA110D module that has pulled SALERT low.

The actions that the host performs are up to the System Designer.

If multiple modules are faulting, SALERT will still be low after doing the above steps and will require transmission with the Alert Response Address repeatedly until all faults are cleared.

Please refer to the PMBus™ Commands section of this document for details on how to monitor specific parameters via the SMBus interface.

PMBus™ SPECIFICATIONS

LGA110D Support PMBus™ Command List

Command Code	Command Name	Default Value	Access Type	Data Bytes	Data Format	Description
00h	PAGE	00h	R/W	1	BIT	Selects Controller 0, 1, or both Page 0 Controller addressed
01h	OPERATION	00h	R/W	1	BIT	Enable/disable, margin settings Immediate off, nominal margin
02h	ON_OFF_CONFIG	17h	R/W	1	BIT	On/off configuration settings ENABLE pin control, active high
03h	CLEAR_FAULTS	N/A	Write	N/A	N/A	Clears faults
15h	STORE_USER_ALL	N/A	Write	N/A	N/A	Stores values to user store
16h	RESTORE_USER_ALL	N/A	Write	N/A	N/A	Restores values from user store
21h	VOUT_COMMAND	N/A	R/W	N/A	L16u	Pin Strap Setting. Sets nominal VOUT set-point
22h	VOUT_TRIM	0000h	R/W	2	L16s	Applies offset voltage to VOUT set-point
23h	VOUT_CAL_OFFSET	0000h	R/W	2	L16s	Applies offset voltage to VOUT set-point
24h	VOUT_MAX	N/A	R/W	N/A	L16u	Sets maximum VOUT set-point 1.15*VOUT pin strap-setting
25h	VOUT_MARGIN_HIGH	N/A	R/W	N/A	L16u	Sets VOUT set-point during margin high 1.05*VOUT pin strap -setting
26h	VOUT_MARGIN_LOW	N/A	R/W	N/A	L16u	Sets VOUT set-point during margin low 0.95*VOUT pin strap- setting
28h	VOUT_DROOP	N/A	R/W	N/A	L11	Sets V/I slope for total rail output current (all phases combined) CFG pin-strap setting
33h	FREQUENCY_SWITCH	N/A	R/W	N/A	L11	Sets switching frequency SYNC pin-strap setting
37h	INTERLEAVE	N/A	R/W	N/A	BIT	Configures phase offset during group Operation Set by pin-strapped PMBus™ address
40h	VOUT_OV_FAULT_LIMIT	N/A	R/W	N/A	L16u	Sets the VOUT overvoltage fault Threshold. 1.1xVOUT pin-strap setting
41h	VOUT_OV_FAULT_RESPONSE	80h	R/W	1	BIT	Sets the VOUT overvoltage fault response. Disable, no retry
44h	VOUT_UV_FAULT_LIMIT	N/A	R/W	N/A	L16u	Sets the VOUT under voltage fault threshold. 0.85xVOUT pin-strap setting
45h	VOUT_UV_FAULT_RESPONSE	80h	R/W	1	BIT	Sets the VOUT under voltage fault response. Disable, no retry
4Fh	OT_FAULT_LIMIT	EBE8h	R/W	2	L11	Sets the over-temperature fault limit. +125 °C
50h	OT_FAULT_RESPONSE	FFh	R/W	1	BIT	Sets the over-temperature fault response. Continuous retry, 280mS retry delay
51h	OT_WARN_LIMIT	EB70h	R/W	2	L11	Sets the over-temperature warning limit. +110 °C
55h	VIN_OV_FAULT_LIMIT	D3E0h	R/W	2	L11	Sets the VIN overvoltage fault threshold. 15.5V
56h	VIN_OV_FAULT_RESPONSE	80h	R/W	1	BIT	Sets the VIN overvoltage fault response. Disable, no retry
57h	VIN_OV_WARN_LIMIT	D3A0h	R/W	2	L11	Sets the VIN overvoltage warning threshold.14.5V
58h	VIN_UV_WARN_LIMIT	CB99	R/W	N/A	L11	Sets the VIN under voltage warning Threshold. 7.297V

PMBus™ SPECIFICATIONS

LGA110D Support PMBus™ Command List

Command Code	Command Name	Default Value	Access Type	Data Bytes	Data Format	Description
59h	VIN_UV_FAULT_LIMIT	CB73	R/W	N/A	L11	Sets the VIN under voltage fault threshold. UVLO pin-strap setting. 6.898V
5Ah	VIN_UV_FAULT_RESPONSE	BFh	R/W	1	BIT	Sets the VIN under voltage fault response. Continuous retries, 280mS retry delay.
5Eh	POWER_GOOD_ON	N/A	R/W	N/A	L16u	Sets the voltage threshold for power-good Indication. 0.9 x VSET pin-strap setting
60h	TON_DELAY	D280h/ CA80h	R/W	2	L11	Sets the delay time from enable to VOUT Rise.Vo1=10mS,Vo2=5mS
61h	TON_RISE	CA80h	R/W	2	L11	Sets the rise time of VOUT after ENABLE and TON_DELAY. 5mS
64h	TOFF_DELAY	CA80h	R/W	2	L11	Sets the delay time from DISABLE to start of VOUT fall. 5mS
65h	TOFF_FALL	CA80h	R/W	2	L11	Sets the fall time for VOUT after DISABLE and TOFF_DELAY. 5mS
78h	STATUS_BYTE	00h	R	1	BIT	First byte of STATUS_WORD. No faults
79h	STATUS_WORD	0000h	R	2	BIT	Summary of critical faults. No faults
7Ah	STATUS_VOUT	00h	R	BIT	BIT	Reports VOUT warnings/faults. No faults
7Bh	STATUS_IOUT	00h	R	BIT	BIT	Reports IOUT warnings/faults. No faults
7Ch	STATUS_INPUT	00h	R	BIT	BIT	Reports input warnings/faults. No faults
7Dh	STATUS_TEMP	00h	R	BIT	BIT	Reports temperature warnings/faults. No faults
7Eh	STATUS_CML	00h	R	BIT	BIT	Reports communication, memory, logic Errors. No faults
80h	STATUS_MFR_SPECIFIC	00h	R	BIT	BIT	Reports voltage monitoring/clock synchronization faults. No faults
88h	READ_VIN	N/A	R	N/A	L11	Reports input voltage measurement
8Bh	READ_VOUT	N/A	R	N/A	L16u	Reports output voltage measurement
8Ch	READ_IOUT	N/A	R	N/A	L11	Reports output current measurement
8Dh	READ_TEMPERATURE_1	N/A	R	L11	N/A	Reports internal temperature measurement
8Fh	READ_TEMPERATURE_3	N/A	R	L11	N/A	Reports external temperature measurement from Mosfet pin
94h	READ_DUTY_CYCLE	N/A	R		L11	Reports actual duty cycle
95h	READ_FREQUENCY	N/A	R		L11	Reports actual switching frequency
98h	PMBus™_REVISION	22h	R	1	BIT	Reports the PMBus™ revision used
99h	MFR_ID	N/A	R/W		ASC	LGA110D-01DADJJB
9Bh	MFR_REVISION	JJ = 303034 JSBJ = 303032	R/W		ASC	Sets a user defined revision.JJB = 001
9Ch	MFR_LOCATION	N/A	R/W		ASC	Sets a user defined location identifier
9Dh	MFR_DATE	N/A	R/W		ASC	Sets a user defined date
9Eh	MFR_SERIAL	N/A	R/W		ASC	Serial number
D1h	USER_CONFIG	N/A	R/W		BIT	Configures several user-level features Set by CFG pin-strap setting

PMBus™ SPECIFICATIONS

LGA110D Support PMBus™ Command List

Command Code	Command Name	Default Value	Access Type	Data Bytes	Data Format	Description
D3h	DDC_CONFIG	N/A	R/W		BIT	Configures the DDC addressing and current sharing. Set by pin-strapped PMBus™ address and CFG pin-strap setting
D4h	POWER_GOOD_DELAY	BA00h	R/W	2	L11	Sets the delay between PG threshold and PG assertion
D5h	MULTI_PHASE_RAMP_GAIN	03h	R/W	1	CUS	Adjusts the ramp-up and ramp-down rate by setting the feedback gain
D7h	SNAPSHOT_FAULT_MASK	00h	R/W	1	00h	Masks faults that cause a snapshot to be Taken. No faults masked
DBh	MFR_SMBALERT_MASK	00h	R/W	1	Custom	Identifies which fault limits will not assert SALRT
DDh	PINSTRAP_READ_STATUS	N/A	Read		BIT	Set by pin-straps
DFh	ASCR_CONFIG	N/A	R/W		BIT	Configures the ASCR settings ASCRCFG pin-strap setting
E0h	SEQUENCE	00h	R/W		BIT	DDC rail sequencing configuration Prequel and sequel disabled
E2h	DDC_GROUP	N/A	R/W		BIT	Configures group ID, fault spreading, OPERATION and VOUT Set by CFG pin-strap
E5h	MFR_IOUT_OC_FAULT_RESPONSE	80h	R/W	1	BIT	Configures the IOUT over current fault Response Disable, no retry
E6h	MFR_IOUT_UC_FAULT_RESPONSE	80h	R/W	1	BIT	Configures the IOUT undercurrent fault Response Disable, no retry
E7h	IOUT_AVG_OC_FAULT_LIMIT	N/A	R/W	L11	L11	Sets the IOUT average over current fault Threshold. Set by CFG pin-strap
E9h	USER_GLOBAL_CONFIG	N/A	R/W		BIT	Sets options pertaining to advanced Feature. Set by CFG pin-strap setting
EAh	SNAPSHOT	N/A	Read		BIT	32-byte read-back of parametric and status values
F0h	LEGACY_FAULT_GROUP	00000000h	R/W		BIT	Configures fault group compatibility with older digital power devices
F3h	SNAPSHOT_CONTROL	00h	R/W	1	BIT	Snapshot feature control command
F4h	RESTORE_FACTORY	N/A	Write	N/A	N/A	Restores device to the hard-coded default values
F5h	MFR_VMON_OV_FAULT_LIMIT	C266h	R/W	2	L11	Sets the VMON overvoltage fault threshold 2.4V, SPS OT trip voltage
F6h	MFR_VMON_UV_FAULT_LIMIT	9B33h	R/W	2	L11	Sets the VMON under voltage fault Threshold.0.1V, corresponds to -50 °C
F7h	MFR_READ_VMON	N/A	Read		L11	Reads the VMON voltage
F8h	VMON_OV_FAULT_RESPONSE	BFh	R/W	1	BIT	Configures the VMON overvoltage fault Response Continuous retry
F9h	VMON_UV_FAULT_RESPONSE	BFh	R/W	1	BIT	Configures the VMON under voltage fault Response. Continuous retry
FAh	SECURITY_LEVEL	01H	Read	1	Hex	Reports the security level Public security level
FBh	PRIVATE_PASSWORD	00...00h	R/W		ASC	Sets the private password string
FCh	PUBLIC_PASSWORD	00...00h	R/W		ASC	Sets the public password string

PMBus™ SPECIFICATIONS

PMBus™ Use Guidelines

The PMBus™ is a powerful tool that allows the user to optimize circuit performance by configuring the LGA110D for their application. When configuring the LGA110D, the LGA110D should be disabled whenever most settings are changed with PMBus commands. Some exceptions to this recommendation are OPERATION, ON_OFF_CONFIG, CLEAR_FAULTS, VOUT_COMMAND, VOUT_MARGIN_HIGH, VOUT_MARGIN_LOW and ASCCR_CONFIG. While the LGA110D is enabled any command can be read. Many commands do not take effect until after the LGA110D has been re-enabled, hence the recommendation that commands that change device settings are written while the LGA110D is disabled. When sending the STORE_DEFAULT_ALL, STORE_USER_ALL, RESTORE_DEFAULT_ALL and RESTORE_USER_ALL commands, it is recommended that no other commands are sent to the device for 100mS after sending STORE or RESTORE commands. In addition, there should be a 2mS delay between repeated READ commands sent to the same device. When sending any other command, a 5mS delay is recommended between repeated commands sent to the same device.

SUMMARY

All commands can be read at any time.

Always disable the LGA110D when writing commands that change device settings. Exceptions to this rule are commands intended to be written while the LGA110D is enabled, for example, VOUT_MARGIN_HIGH.

To be sure a change to LGA110D setting has taken effect, write the STORE_USER_ALL command, then cycle input power and re-enable the LGA110D.

PMBus™ SPECIFICATIONS

PMBus™ Data Formats

Linear-11 (L11)

L11 data format uses 5-bit two's complement exponent (N) and 11-bit two's complement mantissa (Y) to represent real world decimal value (X).

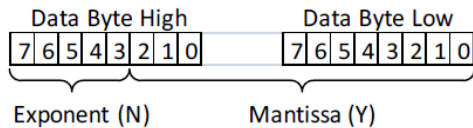

Relation between real world decimal value (X), N and Y is: $X = Y \cdot 2^N$.

Linear-16 Unsigned (L16u)

L16u data format uses a fixed exponent (hard-coded to $N = -13h$) and a 16-bit unsigned integer mantissa (Y) to represent real world decimal value (X). Relation between real world decimal value (X), N and Y is: $X = Y \cdot 2^{-13}$.

Linear-16 Signed (L16s)

L16s data format uses a fixed exponent (hard-coded to $N = -13h$) and a 16-bit two's complement mantissa (Y) to represent real world decimal value (X). Relation between real world decimal value (X), N and Y is: $X = Y \cdot 2^{-13}$.

Bit Field (BIT)

Breakdown of Bit Field is provided in "PMBus™ Command Detail" starting on page 33.

Custom (CUS)

Breakdown of Custom data format is provided in "PMBus™ Command Detail". A combination of Bit Field and integer are common type of Custom data format.

ASCII (ASC)

A variable length string of text characters uses ASCII data format.

Block R/W type

If command type is Block R/W, please add one bit at the beginning defined data length in bytes.

PMBus™ SPECIFICATIONS

PMBus™ Command Detail

PAGE (00h)

Definition: Selects phase1(page 01), phase2(page 00) or both phase1 and 2 to receive commands. All commands following this command will be received and acted on by the selected controller or controllers.

Data Length in Bytes: 1

Data Format: Bit Field

Type: R/W

Protectable: No

Default Value: 00h (Page 0)

Units: N/A

COMMAND	PAGE (00h)							
Format	Bit Field							
Bit Position	7	6	5	4	3	2	1	0
Access	R/W	R/W	R/W	R/W	R/W	R/W	R/W	R/W
Function	See Following Table							
Default Value	0	0	0	0	0	0	0	0

BIT 7:4	BIT 3:0	PAGE
0000	0000	0
0000	0001	1
1111	1111	Both

PMBus™ SPECIFICATIONS

OPERATION (01h)

Definition: Sets Enable, Disable and VOUT Margin settings. This command can also be monitored to read the operating state of the device on bits 7:6. Writing Immediate off will turn off the output and ignore TOFF_DELAY and TOFF_FALL settings. This command is not stored like other PMBus™ commands. The value read reflects the current state of the device. When this command is written the command takes effect, but if a STORE_USER_ALL written and the device is re-enabled, the OPERATION settings may not be the same settings that were written before the device was re-enabled.

Paged or Global: Paged

Data Length in Bytes: 1

Data Format: Bit Field

Type: R/W

Protectable: Yes

Default Value: 00h (immediate off)

Units: N/A

COMMAND	OPERATION (01h)							
Format	Bit Field							
Bit Position	7	6	5	4	3	2	1	0
Access	R/W	R/W	R/W	R/W	R/W	R/W	R/W	R/W
Function	See Following Table							
Default Value	0	0	0	0	0	0	0	0

BIT 7:6	BIT 5:4	BIT 3:0 (NOT USED)	UNIT ON OR OFF	MARGIN STATE
00	00	0000	Immediate off (No sequencing)	N/A
01	00	0000	Soft off (With sequencing)	N/A
10	00	0000	On	Nominal
10	01	0000	On	Margin Low
10	10	0000	On	Margin High

Note: Bit combinations not listed above may cause command errors.

PMBus™ SPECIFICATIONS

ON_OFF_CONFIG (02h)

Definition: Configures the interpretation and coordination of the OPERATION command and the ENABLE pin (EN). When bit 0 is set to 1(turn off the output immediately), the TOFF_FALL setting is ignored.

Paged or Global: Paged

Data Length in Bytes: 1

Data Format: Bit Field

Type: R/W

Protectable: Yes

Default Value: 17h (ENABLE pin control, active high, turn off output immediately – no ramp down)

Units: N/A

COMMAND	ON_OFF_CONFIG (02h)							
Format	Bit Field							
Bit Position	7	6	5	4	3	2	1	0
Access	R/W	R/W	R/W	R/W	R/W	R/W	R/W	R/W
Function	See Following Table							
Default Value	0	0	0	1	0	1	1	1

BIT NUMBER	PURPOSE	BIT VALUE	DESCRIPTION
7:5	Not Used	000	Not used
4:2	Sets the default to either operate any time power is present or for the on/off to be controlled by ENABLE pin or OPERATION command	000	Not used
		101	Device starts from ENABLE pin only.
		110	Device starts from OPERATION command only.
1	(Polarity of ENABLE pin - not used)	1	Active high only.
0	ENABLE pin action when commanding the unit to turn off	0	Use the configured ramp-down settings (“soft-off”)
		1	Turn off the output immediately.

PMBus™ SPECIFICATIONS

CLEAR_FAULTS (03h)

Definition: Clears all fault bits in all registers and releases the SALRT pin (if asserted) simultaneously. If a fault condition still exists, the bit will reassert immediately. This command will not restart a device if it has shut down, it will only clear the faults.

Paged or Global: Global

Data Length in Bytes: 0 Byte

Data Format: N/A

Type: Write only

Protectable: Yes

Default Value: N/A

Units: N/A

STORE_USER_ALL (15h)

Definition: Stores all PMBus™ settings from the operating memory to the nonvolatile USER store memory. To clear the USER store, perform a RESTORE_FACTORY then STORE_USER_ALL. To add to the USER store, perform a RESTORE_USER_ALL, write commands to be added, then STORE_USER_ALL. This command should not be used during device operation, the device will be unresponsive for 100mS while storing values.

Paged or Global: Global

Data Length in Bytes: 0

Data Format: N/A

Type: Write only

Default Value: N/A

Units: N/A

RESTORE_USER_ALL (16h)

Definition: Restores all PMBus™ settings from the USER store memory to the operating memory. Command performed at power-up. Security level is changed to Level 1 following this command. This command should not be used during device operation, the device will be unresponsive for 100mS while restoring values.

Paged or Global: Global

Data Length in Bytes: 0

Data Format: N/A

Type: Write only

Default Value: N/A

Units: N/A

PMBus™ SPECIFICATIONS

VOUT_COMMAND (21h)

Definition: This command sets or reports the target output voltage. The integer value is multiplied by 2 raised to the power of -13h. This command cannot be set to be higher than 115% of the pin-strap VSET setting, or VOUT_MAX if VOUT_MAX is set higher than 115% of the pin-strap VSET setting.

Paged or Global: Paged

Data Length in Bytes: 2

Data Format: Linear -16 Unsigned

Type: R/W

Protectable: Yes

Default Value: VSET pin-strap setting

Units: Volts

Equation: $VOUT = VOUT_COMMAND \times 2^{-13}$

Range: 0 to VOUT_MAX

Example: $VOUT_COMMAND = 699Ah = 27,034$

Target voltage equals $27034 \times 2^{-13} = 3.3V$

COMMAND	VOUT_COMMAND (21h)															
Format	Linear-16 Unsigned															
Bit Position	15	14	13	12	11	10	9	8	7	6	5	4	3	2	1	0
Access	R/W	R/W	R/W	R/W	R/W	R/W	R/W	R/W	R/W	R/W	R/W	R/W	R/W	R/W	R/W	R/W
Default Value	VSET Pin-strap Setting															

PMBus™ SPECIFICATIONS

VOUT_TRIM (22h)

Definition: The VOUT_TRIM command is used to apply a fixed trim voltage to the output voltage command value. This command is typically used by the manufacturer of a power supply subassembly to calibrate a device in the subassembly circuit. The two bytes are formatted as a two's complement binary mantissa, used in conjunction with the exponent of -13h

Paged or Global: Paged

Data Length in Bytes: 2

Data Format: Linear -16 Signed

Type: R/W

Protectable: Yes

Default Value: 0000h

Units: Volts

Equation: VOUT trim = VOUT_TRIM × 2⁻¹³

Range: ±150mV

COMMAND	VOUT_TRIM (22h)															
Format	Linear-16 Unsigned															
Bit Position	15	14	13	12	11	10	9	8	7	6	5	4	3	2	1	0
Access	R/W	R/W	R/W	R/W	R/W	R/W	R/W	R/W	R/W	R/W	R/W	R/W	R/W	R/W	R/W	R/W
Default Value	0	0	0	0	0	0	0	0	0	0	0	0	0	0	0	0

VOUT_CAL_OFFSET (23h)

Definition: The VOUT_CAL_OFFSET command is used to apply a fixed offset voltage to the output voltage command value. This command is typically used by the user to calibrate a device in the application circuit. The two bytes are formatted as a two's complement binary mantissa, used in conjunction with the exponent of -13h.

Paged or Global: Paged

Data Length in Bytes: 2

Data Format: Linear -16 Signed

Type: R/W

Protectable: Yes

Default Value: 0000h

Units: Volts

Equation: VOUT calibration offset = VOUT_CAL_OFFSET × 2⁻¹³

Range: ±150mV

COMMAND	ON_OFF_CONFIG (23h)															
Format	Linear-16 Signed															
Bit Position	15	14	13	12	11	10	9	8	7	6	5	4	3	2	1	0
Access	R/W	R/W	R/W	R/W	R/W	R/W	R/W	R/W	R/W	R/W	R/W	R/W	R/W	R/W	R/W	R/W
Default Value	0	0	0	0	0	0	0	0	0	0	0	0	0	0	0	0

PMBus™ SPECIFICATIONS

VOUT_MAX (24h)

Definition: The VOUT_MAX command sets an upper limit on the output voltage the unit can command regardless of any other commands or combinations. The intent of this command is to provide a safeguard against a user accidentally setting the output voltage to a possibly destructive level rather than to be the primary output overprotection. If a VOUT_COMMAND is sent with a value higher than VOUT_MAX, the device will set the output voltage to VOUT_MAX. Note that this command setting does not automatically scale with a stored VOUT_COMMAND setting.

Paged or Global: Paged

Data Length in Bytes: 2

Data Format: Linear -16 Unsigned

Type: R/W

Protectable: Yes

Default Value: 1.15 x VSET pin-strap setting

Units: Volts

Equation: $V_{OUT\ max} = VOUT_MAX \times 2^{-13}$

Range: 0V to 5.5V

COMMAND	VOUT_MAX (24h)															
Format	Linear-16 Unsigned															
Bit Position	15	14	13	12	11	10	9	8	7	6	5	4	3	2	1	0
Access	R/W	R/W	R/W	R/W	R/W	R/W	R/W	R/W	R/W	R/W	R/W	R/W	R/W	R/W	R/W	R/W
Default Value	1.15 x VSET Pin-strap Setting															

PMBus™ SPECIFICATIONS

VOUT_MARGIN_HIGH (25h)

Definition: Sets the value of the VOUT during a margin high. This VOUT_MARGIN_HIGH command loads the unit with the voltage to which the output is to be changed when the OPERATION command is set to “Margin High”.

Paged or Global: Paged

Data Length in Bytes: 2

Data Format: Linear -16 Unsigned

Type: R/W word

Protectable: Yes

Default Value: 1.05 x VSET pin-strap setting.

Units: Volts

Equation: VOUT margin high = VOUT_MARGIN_HIGH $\times 2^{-13}$

Range: 0V to VOUT_MAX

COMMAND	VOUT_MARGIN_HIGH (25h)															
Format	Linear-16 Unsigned															
Bit Position	15	14	13	12	11	10	9	8	7	6	5	4	3	2	1	0
Access	R/W	R/W	R/W	R/W	R/W	R/W	R/W	R/W	R/W	R/W	R/W	R/W	R/W	R/W	R/W	R/W
Default Value	1.05 x VSET Pin-strap Setting															

VOUT_MARGIN_LOW (26h)

Definition: Sets the value of the VOUT during a margin low. This VOUT_MARGIN_LOW command loads the unit with the voltage to which the output is to be changed when the OPERATION command is set to “Margin Low”.

Paged or Global: Paged

Data Length in Bytes: 2

Data Format: Linear -16 Unsigned

Type: R/W

Protectable: Yes

Default Value: 0.95 x VSET pin-strap setting

Units: Volts

Equation: VOUT margin low = VOUT_MARGIN_LOW $\times 2^{-13}$

Range: 0V to VOUT_MAX

COMMAND	VOUT_MARGIN_LOW (26h)															
Format	Linear-16 Unsigned															
Bit Position	15	14	13	12	11	10	9	8	7	6	5	4	3	2	1	0
Access	R/W	R/W	R/W	R/W	R/W	R/W	R/W	R/W	R/W	R/W	R/W	R/W	R/W	R/W	R/W	R/W
Default Value	0.95 x VSET Pin-strap Setting															

PMBus™ SPECIFICATIONS

VOUT_DROOP (28h)

Definition: The VOUT_DROOP sets the effective load line (V/I slope) for the rail in which the device is used. It is the rate, in mV/A at which the output voltage decreases with increasing output current for use with passive current sharing schemes. For devices that are set to sink output current (negative output current), the output voltage continues to increase as the output current is negative. VOUT_DROOP is not needed with a single (2-phase) LGA110D. VOUT_DROOP is needed when multiple LGA110Ds are operated in current sharing mode, i.e., 4-, 6- and 8-phase configurations. In this case, VOUT_DROOP is calculated based on the combined output current of all phases as applicable.

Paged or Global: Paged

Data Length in Bytes: 2

Data Format: Linear-11

Type: R/W

Protectable: Yes

Default Value: Set by CFG pin-strap setting

Units: mV/A

Equation: $V_{OUT_DROOP} = Y \times 2^N$

Range: 0 to 40mV/A

COMMAND	VOUT_DROOP (28h)															
Format	Linear-11															
Bit Position	15	14	13	12	11	10	9	8	7	6	5	4	3	2	1	0
Access	R/W	R/W	R/W	R/W	R/W	R/W	R/W	R/W	R/W	R/W	R/W	R/W	R/W	R/W	R/W	R/W
Function	Signed Exponent, N								Signed Mantissa, Y							
Default Value	Set by CFG Pin-strap Setting															

For 4/6/8 phase load regulation, VOUT_DROOP is needed to be considered. The following table is the 4/6/8 phase load regulation requirement.

Parameter	Conditions	Min	Nom	Max	Unit
4/6/8 phase Load Regulation	$0.5V \leq V_o \leq 1.0V$ $1.0V < V_o \leq 5.0V$	- -	$I_o \times V_{OUT_DROOP} + 5$ $I_o \times V_{OUT_DROOP} + V_o \times 5$	$I_o \times V_{OUT_DROOP} + 10$ $I_o \times V_{OUT_DROOP} + V_o \times 10$	mV mV

PMBus™ SPECIFICATIONS

FREQUENCY_SWITCH (33h)

Definition: Sets the switching frequency of the device. Initial default value is defined by a pin-strap and this value can be overridden by writing this command. If an external SYNC is utilized, this value should be set as close as possible to the external clock value. The output must be disabled when writing this command. Available frequencies are defined by the equation $f_{SW} = 16\text{MHz}/n$ where $12 \leq n \leq 80$.

Paged or Global: Global

Data Length in Bytes: 2

Data Format: Linear-11

Type: R/W

Protectable: Yes

Default Value: SYNC pin-strap setting

Units: kHz

Equation: $\text{FREQUENCY_SWITCH} = Y \times 2^N$

Range: 533kHz-800kHz

COMMAND	FREQUENCY_SWITCH (33h)															
Format	Linear-11															
Bit Position	15	14	13	12	11	10	9	8	7	6	5	4	3	2	1	0
Access	R/W	R/W	R/W	R/W	R/W	R/W	R/W	R/W	R/W	R/W	R/W	R/W	R/W	R/W	R/W	R/W
Function	Signed Exponent, N						Signed Mantissa, Y									
Default Value	SYNC Pin-strapped Value															

PMBus™ SPECIFICATIONS

INTERLEAVE (37h)

Definition: Configures the phase offset of a device that is sharing a common SYNC clock with other devices. A desired phase position is specified. Interleave is used for setting the phase offset between individual devices, current sharing groups, and/or combinations of devices and current sharing groups. For devices within single current sharing group the phase offset is set automatically. In a multiphase current share group the same interleave settings must be stored in all devices in the current sharing group in order to phase spread properly. Interleave Offset refers to the phase offset of Phase 0 of the device; Phase 1 is always Phase 0 + 180 degrees.

INTERLEAVE Phase offset is calculated with below Equation:

$$\text{Phase Offset (in degrees)} = \{\text{Rounded (Position) * 16 / Number}\} * 22.5$$

Phase offsets greater than 360 degrees are “wrapped around” by subtracting 360 degrees.

Paged or Global: Paged

Data Length in Bytes: 2

Data Format: Bit Field

Type: R/W

Protectable: Yes

Default Value: Set by CFG pin-strap setting

Units: N/A

COMMAND	INTERLEAVE (37h)															
Format	Bit Field															
Bit Position	15	14	13	12	11	10	9	8	7	6	5	4	3	2	1	0
Access	R/W	R/W	R/W	R/W	R/W	R/W	R/W	R/W	R/W	R/W	R/W	R/W	R/W	R/W	R/W	R/W
Function	See Following Table															
Default Value	Set by CFG Pin-strap Setting															

BIT	PURPOSE	VALUE	DESCRIPTION
15:8	Not Used	0	Not used
7:4	Number In Group	0 to 15d	Sets the number of devices in the interleave group. A value of 0 is interpreted as 16.
3:0	Position in Group (Interleave Order)	0 to 15d	Sets position of the device's rail within the group. A value of 0 is interpreted as 16. Position 1 will have a 22.5 degree offset.

PMBus™ SPECIFICATIONS

VOUT_OV_FAULT_LIMIT (40h)

Definition: Sets the VOUT overvoltage fault threshold.

Paged or Global: Paged

Data Length in Bytes: 2

Data Format: Linear-16 Unsigned

Type: R/W

Protectable: Yes

Default Value: 1.10 x VSET pin-strap setting.

Units: Volts

Equation: VOUT OV fault limit = VOUT_OV_FAULT_LIMIT × 2⁻¹³

Range: 0V to 7.99V

COMMAND	VOUT_OV_FAULT_LIMIT (40h)															
Format	Linear-16 Unsigned															
Bit Position	15	14	13	12	11	10	9	8	7	6	5	4	3	2	1	0
Access	R/W	R/W	R/W	R/W	R/W	R/W	R/W	R/W	R/W	R/W	R/W	R/W	R/W	R/W	R/W	R/W
Default Value	1.10 x VSET Pin-strap Setting															

VOUT_OV_FAULT_RESPONSE (41h)

Definition: Configures the VOUT overvoltage fault response. The retry time is the time between restart attempts. It's highly recommended set as default "no retries" Advanced Energy qualified only.

Paged or Global: Paged

Data Length in Bytes: 1

Data Format: Bit Field

Type: R/W

Protectable: Yes

Default Value: 80h (shut down immediately, no retries)

Units: Retry time = 35mS increments

COMMAND	VOUT_OV_FAULT_RESPONSE (41h)							
Format	Bit Field							
Bit Position	7	6	5	4	3	2	1	0
Access	R/W	R/W	R/W	R/W	R/W	R/W	R/W	R/W
Function	See Following Table							
Default Value	1	0	0	0	0	0	0	0

PMBus™ SPECIFICATIONS

BIT NUMBER	FIELD NAME	VALUE	DESCRIPTION
7:6	Response behavior, the device: · Pulls SALRT low · Sets the related fault bit in the status registers. Fault bits are only cleared by the CLEAR_FAULTS command.	00-01	Not used
		10-11	Disable and retry according to the setting in bits [5:3]
5:3	Retry Setting	000	No retry. The output remains disabled until the device is restarted.
		001-110	Not used
		111	Attempts to restart continuously, until it is commanded OFF (by the ENABLE pin or OPERATION command or both), bias power is removed, or another fault condition causes the unit to shutdown. The time between the start of each attempt to restart is set by the value in bits [2:0] multiplied by 35mS.
2:0	Retry Delay	000-111	Retry delay time = (Value +1)*35mS. Sets the time between retries in 35mS increments. Range is 35mS to 280mS.

VOUT_UV_FAULT_LIMIT (44h)

Definition: Sets the VOUT under voltage fault threshold. This fault is masked during ramp, before power-good is asserted or when the device is disabled. VOUT_UV_FAULT_LIMIT should be set to a value below POWER_GOOD

Paged or Global: Paged

Data Length in Bytes: 2

Data Format: Linear-16 Unsigned.

Type: R/W

Protectable: Yes

Default Value: 0.85 x VSET pin-strap setting.

Units: Volts

Equation: VOUT UV fault limit = VOUT_UV_FAULT_LIMIT × 2⁻¹³

Range: 0V to 7.99V

COMMAND	VOUT_UV_FAULT_LIMIT (44h)															
Format	Linear-16 Unsigned															
Bit Position	15	14	13	12	11	10	9	8	7	6	5	4	3	2	1	0
Access	R/W	R/W	R/W	R/W	R/W	R/W	R/W	R/W	R/W	R/W	R/W	R/W	R/W	R/W	R/W	R/W
Default Value	0.85 x VSET Pin-strap Setting															

PMBus™ SPECIFICATIONS

VOUT_UV_FAULT_RESPONSE (45h)

Definition: Configures the VOUT under voltage fault response. Note that VOUT UV faults can only occur after Power-good (PG) has been asserted. Under some circumstances this will cause the output to stay fixed below the power-good threshold indefinitely. If this behavior is undesired, use setting 80h. The retry time is the time between restart attempts. It's highly recommended set as default "no retries" Advanced Energy qualified only.

Paged or Global: Paged

Data Length in Bytes: 1

Data Format: Bit Field

Type: R/W

Protectable: Yes

Default Value: 80h (shut down immediately, no retries)

Units: Retry time unit = 35mS

COMMAND	VOUT_UV_FAULT_RESPONSE (45h)							
Format	Bit Field							
Bit Position	7	6	5	4	3	2	1	0
Access	R/W	R/W	R/W	R/W	R/W	R/W	R/W	R/W
Function	See Following Table							
Default Value	1	0	0	0	0	0	0	0

BIT NUMBER	FIELD NAME	VALUE	DESCRIPTION
7:6	Response Behavior, the device: · Pulls SALRT low · Sets the related fault bit in the status registers. Fault bits are only cleared by the CLEAR_FAULTS command.	00-01	Not used
		10-11	Disable and retry according to the setting in bits [5:3]
5:3	Retry Setting	000	No retry. The output remains disabled until the device is restarted.
		001-110	Not used
		111	Attempts to restart continuously, until it is commanded OFF (by the ENABLE pin or OPERATION command or both), bias power is removed, or another fault condition causes the unit to shutdown. The time between the start of each attempt to restart is set by the value in bits [2:0] multiplied by 35mS.
2:0	Retry Delay	000-111	Retry delay time = (Value +1)*35mS. Sets the time between retries in 35mS increments. Range is 35mS to 280mS.

PMBus™ SPECIFICATIONS

OT_FAULT_LIMIT (4Fh)

Definition: The OT_FAULT_LIMIT command sets the temperature at which the device should indicate an over-temperature fault.

Paged or Global: Paged

Data Length in Bytes: 2

Data Format: Linear-11

Type: R/W

Protectable: Yes

Default Value: EBE8h (+125 °C)

Units: Celsius

Equation: $OT_FAULT_LIMIT = Y \times 2^N$

Range: 0 to 175 °C

COMMAND	OT_FAULT_LIMIT (4Fh)															
Format	Linear-11															
Bit Position	15	14	13	12	11	10	9	8	7	6	5	4	3	2	1	0
Access	R/W	R/W	R/W	R/W	R/W	R/W	R/W	R/W	R/W	R/W	R/W	R/W	R/W	R/W	R/W	R/W
Function	Signed Exponent, N								Signed Mantissa, Y							
Default Value	1	1	1	0	1	0	1	1	1	1	1	0	1	0	0	0

OT_FAULT_RESPONSE (50h)

Definition: The OT_FAULT_RESPONSE command instructs the device on what action to take in response to an over-temperature fault. The retry time is the time between restart attempts.

Paged or Global: Paged

Data Length in Bytes: 1

Data Format: Bit Field

Type: R/W

Protectable: Yes

Default Value: FFh (Continuous retries, retry delay 280mS)

Units: Retry time unit = 35mS

COMMAND	OT_FAULT_RESPONSE (50h)							
Format	Bit Field							
Bit Position	7	6	5	4	3	2	1	0
Access	R/W	R/W	R/W	R/W	R/W	R/W	R/W	R/W
Function	See Following Table							
Default Value	1	0	1	1	1	1	1	1

PMBus™ SPECIFICATIONS

BIT NUMBER	FIELD NAME	VALUE	DESCRIPTION
7:6	Response Behavior, the device: · Pulls SALRT low · Sets the related fault bit in the status registers. Fault bits are only cleared by the CLEAR_FAULTS command	10	Disable and Retry according to the setting in bits [5:3]
		11	Output is disabled while the fault is present. Operation resumes and the output is enabled when the temperature falls below the OT_WARN_LIMIT.
5:3	Retry Setting	000	No retry. The output remains disabled until the device is restarted.
		001-110	Not used
		111	Attempts to restart continuously, until it is commanded OFF (by the ENABLE pin or OPERATION command or both), bias power is removed, or another fault condition causes the unit to shut down. The time between the start of each attempt to restart is set by the value in bits [2:0] multiplied by 35mS.
2:0	Retry Delay	000-111	Retry delay time = (Value +1)*35mS. Sets the time between retries in 35mS increments. Range is 35mS to 280mS.

OT_WARN_LIMIT (51h)

Definition: The OT_WARN_LIMIT command sets the temperature at which the device should indicate an over-temperature warning alarm. In response to the OT_WARN_LIMIT being exceeded, the device: Sets the TEMPERATURE bit in STATUS_WORD, sets the OT_WARNING bit in STATUS_TEMPERATURE and notifies the host.

Paged or Global: Paged

Data Length in Bytes: 2

Data Format: Linear-11

Type: R/W

Protectable: Yes

Default Value: EB70h (+110 °C)

Units: Celsius

Equation: $OT_WARN_LIMIT = Y \times 2^N$

Range: 0 to 175 °C

COMMAND	OT_WARN_LIMIT (51h)															
Format	Linear-11															
Bit Position	15	14	13	12	11	10	9	8	7	6	5	4	3	2	1	0
Access	R/W	R/W	R/W	R/W	R/W	R/W	R/W	R/W	R/W	R/W	R/W	R/W	R/W	R/W	R/W	R/W
Function	Signed Exponent, N					Signed Mantissa, Y										
Default Value	1	1	1	0	1	0	1	1	0	1	1	1	0	0	0	0

PMBus™ SPECIFICATIONS

VIN_OV_FAULT_LIMIT (55h)

Definition: Sets the V_{IN} overvoltage fault threshold. Do not set $VIN_OV_FAULT_LIMIT > 15.5V$, it will damage the module

Paged or Global: Global

Data Length in Bytes: 2

Data Format: Linear-11

Type: R/W

Protectable: Yes

Default Value: D3E0h (15.5V)

Units: Volts

Equation: $VIN_OV_FAULT_LIMIT = Y \times 2^N$

Range: 0 to 15.5V

COMMAND	VIN_OV_FAULT_LIMIT (55h)															
Format	Linear-11															
Bit Position	15	14	13	12	11	10	9	8	7	6	5	4	3	2	1	0
Access	R/W	R/W	R/W	R/W	R/W	R/W	R/W	R/W	R/W	R/W	R/W	R/W	R/W	R/W	R/W	R/W
Function	Signed Exponent, N								Signed Mantissa, Y							
Default Value	1	1	0	1	0	0	1	1	1	1	1	0	0	0	0	0

VIN_OV_FAULT_RESPONSE (56h)

Definition: Configures the V_{IN} overvoltage fault response as defined by the table below. It's highly recommended set as default "no retries" Advanced Energy qualified only.

Paged or Global: Global

Data Length in Bytes: 1

Data Format: Bit Field

Type: R/W

Protectable: Yes

Default Value: 80h (Disable, no retry)

Units: N/A

COMMAND	VIN_OV_FAULT_RESPONSE (56h)							
Format	Bit Field							
Bit Position	7	6	5	4	3	2	1	0
Access	R/W	R/W	R/W	R/W	R/W	R/W	R/W	R/W
Function	See Following Table							
Default Value	1	0	0	0	0	0	0	0

PMBus™ SPECIFICATIONS

BIT NUMBER	FIELD NAME	VALUE	DESCRIPTION
7:6	Response behavior, the device: · Pulls SALRT low · Sets the related fault bit in the status registers. Fault bits are only cleared by the CLEAR_FAULTS command.	00-01	Not used
		10	Disable and retry according to the setting in bits [5:3].
		11	Output is disabled while the fault is present. Operation resumes and the output is enabled when the temperature rises above the VIN_OV_WARN_LIMIT.
5:3	Retry Setting	000	No retry. The output remains disabled until the device is restarted.
		001-110	Not used
		111	Attempts to restart continuously, until it is commanded OFF (by the ENABLE pin or OPERATION command or both), bias power is removed, or another fault condition causes the unit to shut down. The time between the start of each attempt to restart is set by the value in bits [2:0] multiplied by 35mS.
2:0	Retry Delay	000-111	Retry delay time = (Value +1)*35mS. Sets the time between retries in 35mS increments. Range is 35mS to 280mS.

VIN_OV_WARN_LIMIT (57h)

Definition: Sets the V_{IN} overvoltage warning threshold as defined by the table below. In response to the OV_WARN_LIMIT being exceeded, the device: Sets the NONE OF THE ABOVE and INPUT bits in STATUS_WORD, sets the VIN_OV_WARNING bit in STATUS_INPUT and notifies the host.

Paged or Global: Global

Data Length in Bytes: 2

Data Format: Linear-11

Type: R/W

Protectable: Yes

Default Value: D3A0h (14.5V)

Units: Volts

Equation: $VIN_OV_FAULT_LIMIT = Y \times 2^N$

Range: 0 to 19V

COMMAND	VIN_OV_WARN_LIMIT (57h)															
Format	Linear-11															
Bit Position	15	14	13	12	11	10	9	8	7	6	5	4	3	2	1	0
Access	R/W	R/W	R/W	R/W	R/W	R/W	R/W	R/W	R/W	R/W	R/W	R/W	R/W	R/W	R/W	R/W
Function	Signed Exponent, N					Signed Mantissa, Y										
Default Value	1	1	0	1	0	0	1	1	1	1	0	1	0	0	0	0

PMBus™ SPECIFICATIONS

VIN_UV_WARN_LIMIT (58h)

Definition: Sets the VIN under voltage warning threshold. If a VIN_UV_FAULT occurs, the input voltage must rise above VIN_UV_WARN_LIMIT to clear the fault, which provides hysteresis to the fault threshold. In response to the UV_WARN_LIMIT being exceeded, the device: Sets the NONE OF THE ABOVE and INPUT bits in STATUS_WORD, Sets the VIN_UV_WARNING bit in STATUS_INPUT, and notifies the host.

Paged or Global: Global

Data Length in Bytes: 2

Data Format: Linear-11

Type: R/W

Protectable: Yes

Default Value: CBA6 (7.297V)

Units: Volts

Equation: $VIN_UV_WARN_LIMIT = Y \times 2^N$

Range: 0 to 19V

COMMAND	VIN_UV_WARN_LIMIT (58h)															
Format	Linear-11															
Bit Position	15	14	13	12	11	10	9	8	7	6	5	4	3	2	1	0
Access	R/W	R/W	R/W	R/W	R/W	R/W	R/W	R/W	R/W	R/W	R/W	R/W	R/W	R/W	R/W	R/W
Function	Signed Exponent, N								Signed Mantissa, Y							
Default Value	1.10 x UVLO Pin-strap Setting															

VIN_UV_FAULT_LIMIT (59h)

Definition: Sets the V_{IN} under voltage fault threshold.

Paged or Global: Global

Data Length in Bytes: 2

Data Format: Linear-11

Type: R/W

Protectable: Yes

Default Value: CB73h(6.898V)

Units: Volts

Equation: $VIN_UV_WARN_LIMIT = Y \times 2^N$

Range: 0 to 19V

COMMAND	VIN_UV_FAULT_LIMIT (59h)															
Format	Linear-11															
Bit Position	15	14	13	12	11	10	9	8	7	6	5	4	3	2	1	0
Access	R/W	R/W	R/W	R/W	R/W	R/W	R/W	R/W	R/W	R/W	R/W	R/W	R/W	R/W	R/W	R/W
Function	Signed Exponent, N								Signed Mantissa, Y							
Default Value	UVLO pin-strap value															

PMBus™ SPECIFICATIONS

VIN_UV_FAULT_RESPONSE (5Ah)

Definition: Configures the VIN under voltage fault response as defined by the table below. The retry time is the time between restart attempts. It's highly recommended set as default “no retries” Advanced Energy qualified only.

Paged or Global: Global

Data Length in Bytes: 1

Data Format: Bit Field

Type: R/W

Protectable: Yes

Default Value: BFh (continuous retries, 280mS retry delay)

Units: Retry time unit = 35mS

COMMAND	VIN_UV_FAULT_RESPONSE (5Ah)							
Format	Bit Field							
Bit Position	7	6	5	4	3	2	1	0
Access	R/W	R/W	R/W	R/W	R/W	R/W	R/W	R/W
Function	See Following Table							
Default Value	1	0	1	1	1	1	1	1

BIT NUMBER	FIELD NAME	VALUE	DESCRIPTION
7:6	Response Behavior, the device: · Pulls SALRT low · Sets the related fault bit in the status registers. Fault bits are only cleared by the CLEAR_FAULTS command.	00-01	Not used
		10	Disable and retry according to the setting in bits [5:3].
		11	Output is disabled while the fault is present. Operation resumes and the output is enabled when the temperature rises above the UT_WARN_LIMIT.
5:3	Retry Setting	000	No retry. The output remains disabled until the device is restarted.
		001-110	Not used
		111	Attempts to restart continuously, until it is commanded OFF (by the ENABLE pin or OPERATION command or both), bias power is removed, or another fault condition causes the unit to shutdown. The time between the start of each attempt to restart is set by the value in bits [2:0] multiplied by 35mS.
2:0	Retry Delay	000-111	Retry delay time = (Value +1)*35mS. Sets the time between retries in 35mS increments. Range is 35mS to 280mS.

PMBus™ SPECIFICATIONS

POWER_GOOD_ON (5Eh)

Definition: Sets the voltage threshold for power-good indication. Power-good asserts when the output voltage exceeds POWER_GOOD_ON and deasserts when the output voltage is less than VOUT_UV_FAULT_LIMIT. POWER_GOOD_ON should be set to a value above VOUT_UV_FAULT_LIMIT.

Paged or Global: Paged

Data Length in Bytes: 2

Data Format: Linear-16 Unsigned

Type: R/W

Protectable: Yes

Default Value: 0.9 x VSET pin-strap setting.

Units: Volts

COMMAND	POWER_GOOD_ON (5Eh)															
Format	Linear-16 Unsigned															
Bit Position	15	14	13	12	11	10	9	8	7	6	5	4	3	2	1	0
Access	R/W	R/W	R/W	R/W	R/W	R/W	R/W	R/W	R/W	R/W	R/W	R/W	R/W	R/W	R/W	R/W
Default Value	0.9 x VSET Pin-strap Setting															

TON_DELAY (60h)

Definition: Sets the delay time from when the device is enabled to the start of VOUT rise.

Paged or Global: Paged

Data Length in Bytes: 2

Data Format: Linear-11

Type: R/W

Protectable: Yes

Default Value: Vo1= D280h (10mS), Vo2 = CA80h (5mS)

Units: mS

Equation: TON_DELAY = Y × 2^N

Range: 2mS to 5S

COMMAND	TON_DELAY (60h)															
Format	Linear-11															
Bit Position	15	14	13	12	11	10	9	8	7	6	5	4	3	2	1	0
Access	R/W	R/W	R/W	R/W	R/W	R/W	R/W	R/W	R/W	R/W	R/W	R/W	R/W	R/W	R/W	R/W
Function	Signed Exponent, N					Signed Mantissa, Y										
Default Value	1	1	0	0	1	0	1	0	1	0	0	0	0	0	0	0

PMBus™ SPECIFICATIONS

TON_RISE (61h)

Definition: Sets the rise time of VOUT after ENABLE and TON_DELAY for single and dual channel operation. To adjust the rise time in 4-,6- or 8-phase operation, use MULTI_PHASE_RAMP_GAIN (D5h).

Paged or Global: Paged

Data Length in Bytes: 2

Data Format: Linear-11

Type: R/W

Protectable: Yes

Default Value: C300h (3mS)

Units: mS

Equation: $TON_RISE = Y \times 2^N$

Range: 0 to 100mS. Although values can be set below 0.50mS, rise time accuracy cannot be guaranteed. In addition, short rise times may cause excessive input and output currents to flow, thus triggering overcurrent faults at start-up.

COMMAND	TON_RISE (61h)															
Format	Linear-11															
Bit Position	15	14	13	12	11	10	9	8	7	6	5	4	3	2	1	0
Access	R/W	R/W	R/W	R/W	R/W	R/W	R/W	R/W	R/W	R/W	R/W	R/W	R/W	R/W	R/W	R/W
Function	Signed Exponent, N					Signed Mantissa, Y										
Default Value	1	1	0	0	1	0	1	0	1	0	0	0	0	0	0	0

TOFF_DELAY (64h)

Definition: Sets the delay time from DISABLE to start of VOUT fall.

Paged or Global: Paged

Data Length in Bytes: 2

Data Format: Linear-11

Type: R/W

Protectable: Yes

Default Value: CA80h (5mS)

Units: mS

Equation: $TON_DELAY = Y \times 2^N$

Range: 0 to 5 seconds

COMMAND	TOFF_DELAY (64h)															
Format	Linear-11															
Bit Position	15	14	13	12	11	10	9	8	7	6	5	4	3	2	1	0
Access	R/W	R/W	R/W	R/W	R/W	R/W	R/W	R/W	R/W	R/W	R/W	R/W	R/W	R/W	R/W	R/W
Function	Signed Exponent, N					Signed Mantissa, Y										
Default Value	1	1	0	0	1	0	1	0	1	0	0	0	0	0	0	0

PMBus™ SPECIFICATIONS

TOFF_FALL(65h)

Definition: Sets the fall time for VOUT after DISABLE and TOFF_DELAY. This setting is only valid in single or 2-phase operation. Setting the TOFF_FALL to values less than 0.5mS will cause the LGA110D to turn-off both the high and low-side FETs (or disable the DrMOS device) immediately after the expiration of the TOFF_DELAY time. In 4-, 6- or 8-phase operation, the LGA110D will always turn-off both the high and low-side FETs (or disable the DrMOS device) immediately after the expiration of the TOFF_DELAY time.

Paged or Global: Paged

Data Length in Bytes: 2

Data Format: Linear-11

Type: R/W

Protectable: Yes

Default Value: CA80h (5mS)

Units: mS

Equation: $TON_RISE = Y \times 2^N$

Range: 0 to 100mS. Although values can be set below 0.50mS, rise time accuracy cannot be guaranteed. In addition, short rise times may cause excessive input and output currents to flow, thus triggering overcurrent faults at start-up.

COMMAND	TOFF_FALL (65h)															
Format	Linear-11															
Bit Position	15	14	13	12	11	10	9	8	7	6	5	4	3	2	1	0
Access	R/W	R/W	R/W	R/W	R/W	R/W	R/W	R/W	R/W	R/W	R/W	R/W	R/W	R/W	R/W	R/W
Function	Signed Exponent, N					Signed Mantissa, Y										
Default Value	1	1	0	0	1	0	1	0	1	0	0	0	0	0	0	0

STATUS_BYTE (78h)

Definition: The STATUS_WORD command returns two bytes of information with a summary of the unit's fault condition. Based on the information in these bytes, the host can get more information by reading the appropriate status registers. The low byte of the STATUS_WORD is the same register as the STATUS_BYTE (78h) command.

Paged or Global: Paged

Data Length in Bytes: 2

Data Format: Bit Field

Type: Read Only

Protectable: No

Default Value: 00h

Units: N/A

PMBus™ SPECIFICATIONS

COMMAND	STATUS_BYTE (78h)							
Format	Bit Field							
Bit Position	7	6	5	4	3	2	1	0
Access	R	R	R	R	R	R	R	R
Function	See Following Table							
Default Value	0	0	0	0	0	0	0	0

BIT NUMBER	STATUS BIT NAME	DESCRIPTION
7	BUSY	A fault was declared because the device was busy and unable to respond.
6	OFF	This bit is asserted if the unit is not providing power to the output, regardless of the reason, including simply not being enabled.
5	VOUT_OV_FAULT	An output overvoltage fault has occurred.
4	IOUT_OC_FAULT	An output overcurrent fault has occurred.
3	VIN_UV_FAULT	An input undervoltage fault has occurred.
2	TEMPERATURE	A temperature fault or warning has occurred.
1	CML	A communications, memory or logic fault has occurred.
0	None of the above	A fault other than the faults listed in bits 7:1 above has occurred. The source of the fault will be in bits 15:8 of the STATUS_WORD.

STATUS_WORD (79h)

Definition: The STATUS_WORD command returns two bytes of information with a summary of the unit's fault condition. Based on the information in these bytes, the host can get more information by reading the appropriate status registers. The low byte of the STATUS_WORD is the same register as the STATUS_BYTE (78h) command.

Paged or Global: Paged

Data Length in Bytes: 2

Data Format: Bit Field

Type: Read Only

Protectable: No

Default Protectable: No

Default Value: 0000h

Units: N/A

COMMAND	STATUS_WORD (79h)															
Format	Linear-11															
Bit Position	15	14	13	12	11	10	9	8	7	6	5	4	3	2	1	0
Access	R	R	R	R	R	R	R	R	R	R	R	R	R	R	R	R
Function	See Following Table															
Default Value	0	0	0	0	0	0	0	0	0	0	0	0	0	0	0	0

PMBus™ SPECIFICATIONS

BIT NUMBER	STATUS BIT NAME	DESCRIPTION
15	VOUT	An output voltage fault or warning has occurred.
14	IOUT	An output current fault has occurred.
13	INPUT	An input voltage fault or warning has occurred.
12	MFG_SPECIFIC	A manufacturer specific fault or warning has occurred.
11	POWER_GOOD#	The POWER_GOOD signal, if present, is negated. (Note 1)
10	NOT USED	Not used
9	OTHER	A bit in STATUS_VOUT, STATUS_IOUT, STATUS_INPUT, STATUS_TEMPERATURE, STATUS_CML, or STATUS_MFR_SPECIFIC is set.
8	NOT USED	Not used
7	BUSY	A fault was declared because the device was busy and unable to respond.
6	OFF	This bit is asserted if the unit is not providing power to the output, regardless of the reason, including simply not being enabled.
5	VOUT_OV_FAULT	An output overvoltage fault has occurred.
4	VOUT_OC_FAULT	An output overcurrent fault has occurred.
3	VIN_UV_FAULT	An input undervoltage fault has occurred.
2	TEMPERATURE	A temperature fault or warning has occurred.
1	CML	A communications, memory or logic fault has occurred.
0	None of the above	A fault other than the faults listed in bits 7:1 above has occurred. The source of the fault will be in bits 15:8 of the STATUS_WORD.

NOTE 1: If the POWER_GOOD# bit is set, this indicates that the POWER_GOOD signal, if present, is signaling that the output power is not good.

PMBus™ SPECIFICATIONS

STATUS_VOUT (7Ah)

Definition: The STATUS_VOUT command returns one data byte with the status of the output voltage.

Paged or Global: Paged

Data Length in Bytes: 1

Data Format: Bit Field

Type: Read Only

Protectable: No

Default Protectable: No

Default Value: 00h

Units: N/A

COMMAND	STATUS_VOUT(7Ah)							
Format	Bit Field							
Bit Position	7	6	5	4	3	2	1	0
Access	R	R	R	R	R	R	R	R
Function	See Following Table							
Default Value	0	0	0	0	0	0	0	0

BIT NUMBER	STATUS BIT NAME	DESCRIPTION
7	VOUT_OV_FAULT	Indicates an output overvoltage fault.
6	VOUT_OV_WARNING	Not Used
5	VOUT_UV_WARNING	Not Used
4	VOUT_UV_FAULT	Indicates an output under voltage fault.
3:0	Not Used	Not Used

PMBus™ SPECIFICATIONS

STATUS_IOUT (7Bh)

Definition: The STATUS_IOUT command returns one data byte with the status of the output current.

Paged or Global: Paged

Data Length in Bytes: 1

Data Format: Bit Field

Type: Read Only

Protectable: No

Default Value: 00h

Units: N/A

COMMAND	STATUS_IOUT (7Bh)							
Format	Bit Field							
Bit Position	7	6	5	4	3	2	1	0
Access	R	R	R	R	R	R	R	R
Function	See Following Table							
Default Value	0	0	0	0	0	0	0	0

BIT NUMBER	STATUS BIT NAME	DESCRIPTION
7	IOUT_OC_FAULT	An output over current fault has occurred.
6	Not Used	Not Used
5	Not Used	Not Used
4	IOUT_UC_FAULT	An output undercurrent fault has occurred.
3:0	Not Used	Not Used

PMBus™ SPECIFICATIONS

STATUS_INPUT(7Ch)

Definition: The STATUS_INPUT command returns input voltage and input current status information.

Paged or Global: Global

Data Length in Bytes: 1

Data Format: Bit Field

Type: Read Only

Protectable: No

Default Value: 00h

Units: N/A

COMMAND	STATUS_INPUT (7Ch)							
Format	Bit Field							
Bit Position	7	6	5	4	3	2	1	0
Access	R	R	R	R	R	R	R	R
Function	See Following Table							
Default Value	0	0	0	0	0	0	0	0

BIT NUMBER	STATUS BIT NAME	DESCRIPTION
7	VIN_OV_FAULT	An input overvoltage fault has occurred.
6	VIN_OV_WARNING	An input overvoltage warning has occurred.
5	VIN_UV_WARNING	An input undervoltage warning has occurred.
4	VIN_UV_FAULT	An input undervoltage fault has occurred.
3:0	Not Used	Not Used

PMBus™ SPECIFICATIONS

STATUS_TEMPERATURE (7Dh)

Definition: The STATUS_TEMPERATURE command returns one byte of information with a summary of any temperature related faults or warnings.

Paged or Global: Paged

Data Length in Bytes: 1

Data Format: Bit Field

Type: Read Only

Protectable: No

Default Value: 00h

Units: N/A

COMMAND	STATUS_TEMP (7Dh)							
Format	Bit Field							
Bit Position	7	6	5	4	3	2	1	0
Access	R	R	R	R	R	R	R	R
Function	See Following Table							
Default Value	0	0	0	0	0	0	0	0

BIT NUMBER	STATUS BIT NAME	DESCRIPTION
7	OT_FAULT	An over-temperature fault has occurred.
6	OT_WARNING	An over-temperature warning has occurred.
5	UT_WARNING	An under-temperature warning has occurred.
4	UV_FAULT	An under-voltage fault has occurred.
3:0	NOT USED	Not Used

PMBus™ SPECIFICATIONS

STATUS_CML(7Eh)

Definition: The STATUS_WORD command returns one byte of information with a summary of any communications, logic and/or memory errors.

Paged or Global: Global

Data Length in Bytes: 1

Data Format: Bit Field

Type: Read Only

Protectable: No

Default Value: 00h

Units: N/A

COMMAND	STATUS_CML (7Eh)							
Format	Bit Field							
Bit Position	7	6	5	4	3	2	1	0
Access	R	R	R	R	R	R	R	R
Function	See Following Table							
Default Value	0	0	0	0	0	0	0	0

BIT NUMBER	DESCRIPTION
7	Invalid or unsupported PMBus™ command was received.
6	The PMBus™ command was sent with invalid or unsupported data.
5	A packet error was detected in the PMBus™ command.
4:2	Not used
1	A PMBus™ command tried to write to a read-only or protected command, or a communication fault other than the ones listed in this table has occurred.
0	Not used

PMBus™ SPECIFICATIONS

STATUS_MFR_SPECIFIC (80h)

Definition: The STATUS_MFR_SPECIFIC command returns one byte of information providing the status of the device's voltage monitoring and clock synchronization faults.

Paged or Global: Global

Data Length in Bytes: 1

Data Format: Bit Field

Type: Read Only

Protectable: No

Default Value: 00h

Units: N/A

COMMAND	STATUS_MFR_SPECIFIC (80h)							
Format	Bit Field							
Bit Position	7	6	5	4	3	2	1	0
Access	R	R	R	R	R	R	R	R
Function	See Following Table							
Default Value	0	0	0	0	0	0	0	0

BIT NUMBER	FIELD NAME	DESCRIPTION
7	Not Used	Not Used
6	DDC Warning	An error was detected on the DDC bus.
5	VMON UV Warning	The voltage on the VMON pin has dropped 10% below the level set by MFR_VMON_UV_FAULT.
4	VMON OV Warning	The voltage on the VMON pin has risen 10% above the level set by MFR_VMON_OV_FAULT.
3	External Switching Period Fault	Loss of external clock synchronization has occurred.
2	Not Used	Not Used
1	VMON UV Fault	The voltage on the VMON pin has dropped below the level set by MFR_VMON_UV_FAULT.
0	VMON OV Fault	The voltage on the VMON pin has risen above the level set by MFR_VMON_OV_FAULT.

PMBus™ SPECIFICATIONS

READ_VIN (88h)

Definition: Returns the input voltage reading.

Paged or Global: Global

Data Length in Bytes: 2

Data Format: Linear-11

Type: Read Only

Protectable: No

Default Value: N/A

Units: Volts

Equation: $READ_VIN = Y \times 2^N$

Range: N/A

COMMAND	READ_VIN (88h)															
Format	Linear-11															
Bit Position	15	14	13	12	11	10	9	8	7	6	5	4	3	2	1	0
Access	R	R	R	R	R	R	R	R	R	R	R	R	R	R	R	R
Function	Signed Exponent, N						Signed Mantissa, Y									
Default Value	N/A															

PMBus™ SPECIFICATIONS

READ_VOUT (8Bh)

Definition: Returns the output voltage reading.

Paged or Global: Paged

Data Length in Bytes: 2

Data Format: Linear-16 Unsigned

Type: Read Only

Protectable: No

Default Value: N/A

Equation: $READ_VOUT = READ_VOUT \times 2^{-13}$

Units: Volts

COMMAND	READ_VOUT (8Bh)															
Format	Linear-16 Unsigned															
Bit Position	15	14	13	12	11	10	9	8	7	6	5	4	3	2	1	0
Access	R	R	R	R	R	R	R	R	R	R	R	R	R	R	R	R
Default Value	N/A															

READ_IOUT(8Ch)

Definition: Returns the input current reading.

Paged or Global: Paged

Data Length in Bytes: 2

Data Format: Linear-11

Type: Read Only

Protectable: No

Default Value: N/A

Units: A

Equation: $READ_IOUT = Y \times 2^N$

Range: N/A

COMMAND	READ_IOUT(8Ch)															
Format	Linear-11															
Bit Position	15	14	13	12	11	10	9	8	7	6	5	4	3	2	1	0
Access	R	R	R	R	R	R	R	R	R	R	R	R	R	R	R	R
Function	Signed Exponent, N							Signed Mantissa, Y								
Default Value	N/A															

PMBus™ SPECIFICATIONS

READ_TEMPERATURE_1(8Dh)

Definition: Returns the temperature reading internal to the device.

Paged or Global: Global

Data Length in Bytes: 2

Data Format: Linear-11

Type: Read Only

Protectable: No

Default Value: N/A

Units: °C

Equation: $READ_TEMPERATURE_1 = Y \times 2^N$

Range: N/A

COMMAND	READ_TEMPERATURE_1 (8Dh)															
Format	Linear-11															
Bit Position	15	14	13	12	11	10	9	8	7	6	5	4	3	2	1	0
Access	R	R	R	R	R	R	R	R	R	R	R	R	R	R	R	R
Function	Signed Exponent, N					Signed Mantissa, Y										
Default Value	N/A															

PMBus™ SPECIFICATIONS

READ_TEMPERATURE_3(8Fh)

Definition: Returns the temperature reading from the DrMOS.

Paged or Global: Paged

Data Length in Bytes: 2

Data Format: Linear-11

Type: Read Only

Protectable: No

Default Value: N/A

Units: °C

Equation: $READ_TEMPERATURE_1 = Y \times 2^N$

Range

COMMAND	READ_TEMPERATURE_3 (8Fh)															
Format	Linear-11															
Bit Position	15	14	13	12	11	10	9	8	7	6	5	4	3	2	1	0
Access	R	R	R	R	R	R	R	R	R	R	R	R	R	R	R	R
Function	Signed Exponent, N								Signed Mantissa, Y							
Default Value	N/A															

READ_DUTY_CYCLE (94h)

Definition: Reports the actual duty cycle of the converter during the enable state.

Paged or Global: Global

Data Length in Bytes: 2

Data Format: Linear-11

Type: Read Only

Protectable: No

Default Value: N/A

Units: %

Equation: $READ_DUTY_CYCLE = Y \times 2^N$

Range: 0 to 100%

COMMAND	READ_DUTY_CYCLE (94h)															
Format	Linear-11															
Bit Position	15	14	13	12	11	10	9	8	7	6	5	4	3	2	1	0
Access	R	R	R	R	R	R	R	R	R	R	R	R	R	R	R	R
Function	Signed Exponent, N								Signed Mantissa, Y							
Default Value	N/A															

PMBus™ SPECIFICATIONS

READ_FREQUENCY (95h)

Definition: Reports the actual switching frequency of the converter during the enable state.

Paged or Global: Global

Data Length in Bytes: 2

Data Format: Linear-11

Type: Read Only

Default Value: N/A

Units: kHz

Equation: $READ_FREQUENCY = Y \times 2^N$

Range: N/A

COMMAND	READ_FREQUENCY (95h)															
Format	Linear-11															
Bit Position	15	14	13	12	11	10	9	8	7	6	5	4	3	2	1	0
Access	R	R	R	R	R	R	R	R	R	R	R	R	R	R	R	R
Function	Signed Exponent, N								Signed Mantissa, Y							
Default Value	N/A															

PMBus™_REVISION (98h)

Definition: The PMBus™_REVISION command returns the revision of the PMBus™ Specification to which the device is compliant.

Data Length in Bytes: 1

Data Format: Bit Field

Type: Read Only

Protectable: N/A

Default Value: 22h (Part 1 Revision 1.2, Part 2 Revision 1.2)

Units: N/A

COMMAND	PMBus™_REVISION (98h)								
Format	Bit Field								
Bit Position	7	6	5	4	3	2	1	0	
Access	R	R	R	R	R	R	R	R	R
Function	See Following Table								
Default Value	0	0	1	0	0	0	1	0	

BIT 7:4	RART 1 REVISION	BIT 3:0	RART 2 REVISION
0000	1.0	0000	1.0
0001	1.1	0001	1.1
0010	1.2	0010	1.2

PMBus™ SPECIFICATIONS

MFR_ID (99h)

Definition: MFR_ID sets a user defined identification string not to exceed 32 bytes. The sum total of characters in MFR_ID, MFR_MODEL, MFR_REVISION, MFR_LOCATION, MFR_DATE, MFR_SERIAL and USER_DATA_00 plus one byte per command cannot exceed 128bytes. This limitation includes multiple writes of this command before a STORE command. To clear multiple writes, perform a RESTORE, write this command then perform a STORE/RESTORE.

Paged or Global: Global

Data Length in Bytes: User defined

Data Format: ASCII, ISO/IEC 8859-1

Type: Block R/W

Protectable: Yes

Default Value: LGA110D-01DADJJB

Units: N/A

MFR_REVISION (9Bh)

Definition: MFR_REVISION sets a user defined revision string not to exceed 32 bytes. The sum total of characters in MFR_ID, MFR_MODEL, MFR_REVISION, MFR_LOCATION, MFR_DATE, MFR_SERIAL and USER_DATA_00 plus one byte per command cannot exceed 128bytes. This limitation includes multiple writes of this command before a STORE command. To clear multiple writes, perform a RESTORE, write this command then perform a STORE/RESTORE.

Paged or Global: Global

Data Length in Bytes: User defined

Data Format: ASCII, ISO/IEC 8859-1

Type: Block R/W

Protectable: Yes

Default Value: 001

Units: N/A

MFR_LOCATION (9Ch)

Definition: MFR_LOCATION sets a user defined location identifier string not to exceed 32 bytes. The sum total of characters in MFR_ID, MFR_MODEL, MFR_REVISION, MFR_LOCATION, MFR_DATE, MFR_SERIAL and USER_DATA_00 plus one byte per command cannot exceed 128bytes. This limitation includes multiple writes of this command before a STORE command. To clear multiple writes, perform a RESTORE, write this command then perform a STORE/RESTORE.

Paged or Global: Global

Data Length in Bytes: User defined

Data Format: ASCII, ISO/IEC 8859-1

Type: Block R/W

Protectable: Yes

Default Value: Null

Units: N/A

PMBus™ SPECIFICATIONS

MFR_DATE (9Dh)

Definition: MFR_DATE sets a user defined date string not to exceed 32 bytes. The sum total of characters in MFR_ID, MFR_MODEL, MFR_REVISION, MFR_LOCATION, MFR_DATE, MFR_SERIAL and USER_DATA_00 plus one byte per command cannot exceed 128bytes. This limitation includes multiple writes of this command before a STORE command. To clear multiple writes, perform a RESTORE, write this command then perform a STORE/RESTORE.

Paged or Global: Global

Data Length in Bytes: User defined

Data Format: ASCII. ISO/IEC 8859-1

Type: Block R/W

Protectable: Yes

Default Value: Null

Units: N/A

MFR_SERIAL (9Eh)

Definition: MFR_SERIAL sets a user defined serialized identifier string not to exceed 32 bytes. The sum total of characters in MFR_ID, MFR_MODEL, MFR_REVISION, MFR_LOCATION, MFR_DATE, MFR_SERIAL and USER_DATA_00 plus one byte per command cannot exceed 128bytes. This limitation includes multiple writes of this command before a STORE command. To clear multiple writes, perform a RESTORE, write this command then perform a STORE/RESTORE.

Paged or Global: Global

Data Length in Bytes: User defined

Data Format: ASCII. ISO/IEC 8859-1

Type: Block R/W

Protectable: Yes

Default Value: Null

Units: N/A

USER_DATA_00 (B0h)

Definition: USER_DATA_00 sets a user defined data string not to exceed 32 bytes. The sum total of characters in MFR_ID, MFR_MODEL, MFR_REVISION, MFR_LOCATION, MFR_DATE, MFR_SERIAL and USER_DATA_00 plus one byte per command cannot exceed 128bytes. This limitation includes multiple writes of this command before a STORE command. To clear multiple writes, perform a RESTORE, write this command then perform a STORE/RESTORE.

Paged or Global: Global

Data Length in Bytes: User defined

Data Format: ASCII. ISO/IEC 8859-1

Type: Block R/W

Protectable: Yes

Default Value: Null

Units: N/A

PMBus™ SPECIFICATIONS

USER_CONFIG (D1h)

Definition: Configures several user-level features. This command should be saved immediately after being written to the desired user or default store. This is recommended when written as an individual command or as part of a series of commands in a configuration file or script.

Paged or Global: Paged

Data Length in Bytes: 2

Data Format: Bit Field

Type: R/W

Protectable: Yes

Default Value: 1080h

Units: N/A

COMMAND	USER_CONFIG (D1h)															
Format	Bit Field															
Bit Position	15	14	13	12	11	10	9	8	7	6	5	4	3	2	1	0
Access	R/W	R/W	R/W	R/W	R/W	R/W	R/W	R/W	R/W	R/W	R/W	R/W	R/W	R/W	R/W	R/W
Function	See Following Table															
Default Value	CFG Pin-strap Setting															

BIT	FIELD NAME	VALUE	SETTING	DESCRIPTION
15:11	Minimum Duty Cycle	00010	0-31d	Sets the minimum duty-cycle to $2X(VALUE+1)/512$. Must be enabled with Bit 7
10	Not Used	1	Not Used	Not Used
9:8	Not Used	00	Not Used	Not Used
7	Minimum Duty Cycle Control	1	Enable	Control for minimum duty cycle
6	Not Used	0	Not Used	Not Used
5	VSET Select	0	VSET0	0 = Uses only VSET0 to set the pin-strapped output voltage
		1	VSET1	1 = Uses only VSET1 to set the pin-strapped output voltage
4	Not Used	0	Not Used	Not Used
3	PWNL disabled state	0	Low when disabled	PWML is low (off) when device is disabled (bit 3 set to 0), or high (on) when device is disabled (bit 3 set to 1)
2	Power-good Configuration	1	Push-Pull	1 = PG is push-pull output

BIT	FIELD NAME	VALUE	SETTING	DESCRIPTION
1	XTEMP Enable	0	Disable	Enable external temperature sensor
0	XTEMP Fault Select	0	Disable	Selects external temperature sensor to determine temperature faults

PMBus™ SPECIFICATIONS

DDC_CONFIG (D3h)

Definition: Configures DDC addressing and current sharing for up to 8 phases. To operate as a 2-phase controller, set both phases to the same rail ID, set phases in rail to 2, then set each phase ID sequentially as 0 and 1. To operate as a 4-phase controller, set all phases to the same rail ID, set phases in rail to 4, then set each phase ID alternately, for example, the first LGA110D will be set to 0 and 2, the second LGA110D will be set to 1 and 3. The LGA110D will automatically equally offset the phases in the rail. Phase spreading is done automatically as part of the DDC_CONFIG command. When using CFG pin-strap settings, the DDC_CONFIG command is set automatically.

NOTE: The output MUST be connected to VSEN0P and VSEN0N when operating as a 2-phase controller.

Paged or Global: Paged

Data Length in Bytes: 2

Data Format: Bit Field

Type: R/W

Protectable: Yes

Default Value: PMBus™ address pin-strap dependent.

Units: N/A

COMMAND	DDC_CONFIG (D3h)															
Format	Bit Field															
Bit Position	15	14	13	12	11	10	9	8	7	6	5	4	3	2	1	0
Access	R/W	R/W	R/W	R/W	R/W	R/W	R/W	R/W	R/W	R/W	R/W	R/W	R/W	R/W	R/W	R/W
Function	See Following Table															
Default Value	0	0	0	Lower 5 bits of device address				0	0	0	0	0	0	0	0	0

BIT	FIELD NAME	VALUE	SETTING	DESCRIPTION
15:13	Phase ID	0 to 7	0	Sets the output's phase position within the rail
12:8	Rail ID	0 to 31d	0	Identifies the device as part of a current sharing rail (Shared output)
7:3	Not Used	00	00	Not Used
2:0	Phases In Rail	0 to 7	0	Identifies the number of phases on the same rail (+1)

PMBus™ SPECIFICATIONS

POWER_GOOD_DELAY (D4h)

Definition: Sets the delay applied between the output exceeding the PG threshold (POWER_GOOD_ON) and asserting the PG pin. The delay time can range from 0mS up to 500mS, in steps of 125nS. A 1ms minimum configured value is recommended to apply proper debounce to this signal.

Paged or Global: Paged

Data Length in Bytes: 2

Data Format: Linear-11

Type: R/W

Protectable: Yes

Default Value: BA00h, 1mS

Units: mS

Equation: $POWER_GOOD_DELAY = Y \times 2^N$

Range: 0 to 500mS

COMMAND	POWER_GOOD_DELAY (D4h)															
Format	Linear-11															
Bit Position	15	14	13	12	11	10	9	8	7	6	5	4	3	2	1	0
Access	R/W	R/W	R/W	R/W	R/W	R/W	R/W	R/W	R/W	R/W	R/W	R/W	R/W	R/W	R/W	R/W
Function	Signed Exponent, N					Signed Mantissa, Y										
Default Value	1	0	1	1	1	0	1	0	0	0	0	0	0	0	0	0

PMBus™ SPECIFICATIONS

MULTI_PHASE_RAMP_GAIN (D5h)

Definition: MULTI_PHASE_RAMP_GAIN command value indirectly determines the output voltage rise time during the turn-on ramp. Typical gain values range from 1 to 10. Lower gain values produce longer ramp times. MULTI_PHASE_RAMP_GAIN mode is automatically selected when the LGA110D is configured to operate in a 4-phase current sharing group. When in MULTI_PHASE_RAMP_GAIN mode, the turn-on ramp up is done with the high bandwidth ASCR control circuitry disabled, resulting in a lower loop bandwidth during start-up ramps. Once POWER_GOOD has been asserted, ASCR circuitry is enabled and the LGA110D operates normally. When MULTI_PHASE_RAMP_GAIN mode is enabled, soft-off ramps are not allowed (TOFF_FALL is ignored). When the LGA110D is commanded to shutdown, the PWMHO/1 output is tri-stated, turning both the high-side and low-side MOSFETs off, and the PWML0/1 pin is pulled low (DrMOS disabled). Large load current transitions during multiphase ramp-ups will cause output voltage discontinuities. When the phase count is 2; i.e., when the LGA110D is operating standalone, ASCR is enabled at all times and all commands associated with turn-on and turn-off (TON_RISE, TOFF_FALL, Soft-Off) operate normally.

Rise time can be calculated using Equation 7:

$$\text{RiseTime} = \text{VOUT_COMMAND} / \{14 \cdot \text{Input Voltage} \cdot \text{FREQUENCY_SWITCH (in MHz)} \cdot \text{MULTI_PHASE_RAMP_GAIN}\} \quad (\text{EQ. 7})$$

Paged or Global: Global

Data Length in Bytes: 1

Data Format: Custom

Type: R/W

Protectable: Yes

Default Value: 03h

Units: N/A

COMMAND	MULTI_PHASE_RAMP_GAIN (D5h)							
Format	1 Byte Binary							
Bit Position	7	6	5	4	3	2	1	0
Access	R/W	R/W	R/W	R/W	R/W	R/W	R/W	R/W
Default Value	0	0	0	0	0	0	1	1

BIT	FIELD NAME	VALUE	SETTING	DESCRIPTION
7:0	Gain	00-FF	00	Start-up ramp gain

PMBus™ SPECIFICATIONS

SNAPSHOT_FAULT_MASK (D7h)

Definition: Prevents faults from causing a SNAPSHOT event (and store) from occurring.

Data Length in Bytes: 2

Data Format: BIT

Type: R/W

Protectable: Yes

Default Value: 0000h

Units: NA

Range: NA

COMMAND	SNAPSHOT_FAULT_MASK (D7h)															
Format	Bit Field															
Bit Position	15	14	13	12	11	10	9	8	7	6	5	4	3	2	1	0
Access	R	R	R	R	R	R	R	R	R	R	R	R	R	R	R	R
Function																
Default Value	0	0	0	0	0	0	0	0	0	0	0	0	0	0	0	0

BIT	STATUS BIT NAME	DESCRIPTION
15:14	Not Used	Not Used
13	Group	Ignore Fault Spreading faults
12	Phase	Ignore Other Phase faults
11	CPU	Ignore CPU faults
10	CRC	Ignore CRC Memory faults
9	Not Used	Not used
8	Not Used	Not Used
7	IOUT_UC_FAULT	Ignore output undercurrent faults
6	IOUT_OC_FAULT	Ignore output overcurrent faults
5	VIN_UV_FAULT	Ignore input undervoltage faults
4	VIN_OV_FAULT	Ignore Input overvoltage faults
3	UT_FAULT	Ignore under-temperature faults
2	OT_FAULT	Ignore over-temperature faults
1	VOUT_UV_FAULT	Ignore output undervoltage faults
0	VOUT_OV_FAULT	Ignore output overvoltage faults

PMBus™ SPECIFICATIONS

MFR_SMBALERT_MASK (DBh)

Definition: The MFR_SMBALERT_MASK command is used to prevent faults from activating the SALRT pin. The bits in each byte correspond to a specific fault type as defined in the STATUS command.

Data Length in Bytes: 7

Data Format: Bit Field

Type: R/W

Protectable: Yes

Default Value: 00 00 00 00 00 00 00h (No faults masked)

Units: N/A

COMMAND	OVUV_CONFIG (DBh)							
Format	Bit Field							
Access	R/W	R/W	R/W	R/W	R/W	R/W	R/W	R/W
Function	See Following Table							
Bit Position	55	54	53	52	51	50	49	48
Default Value Byte 6	0	0	0	0	0	0	0	0
Bit Position	47	46	45	44	43	42	41	40
Default Value Byte 5	0	0	0	0	0	0	0	0
Bit Position	39	38	37	36	35	34	33	32
Default Value Byte 4	0	0	0	0	0	0	0	0
Bit Position	31	30	29	28	27	26	25	24
Default Value Byte 3	0	0	0	0	0	0	0	0
Bit Position	23	22	21	20	19	18	17	16
Default Value Byte 2	0	0	0	0	0	0	0	0
Bit Position	15	14	13	12	11	10	9	8
Default Value Byte 1	0	0	0	0	0	0	0	0
Bit Position	7	6	5	4	3	2	1	0
Default Value Byte 0	0	0	0	0	0	0	0	0

PMBus™ SPECIFICATIONS

BIT	STATUS BIT NAME	DESCRIPTION
6	STATUS_MFR_SPECIFIC	Mask manufacturer specific faults as identified in the STATUS_MFR_SPECIFIC byte.
5	STATUS_OTHER	Not used
4	STATUS_CML	Mask communications, memory or logic specific faults as identified in the STATUS_CML byte.
3	STATUS_TEMPERATURE	Mask temperature specific faults as identified in the STATUS_TEMPERATURE byte
2	STATUS_INPUT	Mask input specific faults as identified in the STATUS_INPUT byte
1	STATUS_IOUT	Mask output current specific faults as identified in the STATUS_IOUT byte
0	STATUS_VOUT	Mask output voltage specific faults as identified in the STATUS_VOUT byte

PINSTRAP_READ_STATUS (DDh)

Definition: Reads back 7 bytes of 8 bit values that represent the pin-strap settings of each of the device's pin-strap pins. This value corresponds to a resistor value, a high, a low or an open condition. The pin decode values correspond to pin-strap settings according to:

R (Kohm)	DECODE	R (Kohm)	DECODE
10	00	51.1	11
11	01	56.2	12
12.1	02	61.9	13
13.3	03	68.1	14
14.7	04	75	15
16.2	05	82.5	16
17.8	06	90.9	17
19.6	07	100	18
21.5	08	110	19
23.7	09	121	1A
26.1	0A	133	1B
28.1	0B	147	1C
31.6	0C	162	1D
34.8	0D	178	1E
38.3	0E	LOW	F1
42.2	0F	OPEN	F2
46.4	10	HIGH	F3

PMBus™ SPECIFICATIONS

Paged or Global: Global

Data Length in Bytes: 7

Data Format: Bit Field

Type: Read Only

Protectable: Yes

Default Value: Pin-strap settings

Units: N/A

COMMAND	READ_PINSTRAP (DDh)							
Format	Bit Field							
Access	R	R	R	R	R	R	R	R
Bit Position	55	54	53	52	51	50	49	48
Function	ASCRCFG Pin Decode							
Default Value	ASCRCFG Pin-strap Setting							
Bit Position	47	46	45	44	43	42	41	40
Function	CFG Pin Decode							
Default Value	CFG Pin-strap Setting							
Bit Position	39	38	37	36	35	34	33	32
Function	SYNC Pin Decode							
Default Value	SYNC Pin-strap Setting							
Bit Position	31	30	29	28	27	26	25	24
Function	UVLO Pin Decode							
Default Value	UVLO Pin-strap Setting							
Bit Position	23	22	21	20	19	18	17	16
Function	VSET0 Pin Decode							
Default Value	VSET0 Pin-strap Setting							
Bit Position	15	14	13	12	11	10	9	8
Function	VSET1 Pin Decode							
Default Value	VSET1 Pin-strap Setting							
Bit Position	7	6	5	4	3	2	1	0
Function	Reserved							
Default Value	N/A							

PMBus™ SPECIFICATIONS

BIT	FIELD NAME	VALUE	DESCRIPTION
55:48	ASCRCFG Pin Decode	00-F4h	Decode value of ASCRCFG pin-strap setting
47:40	CFG Pin Decode	00-F4h	Decode value of CFG pin-strap setting
39:32	SYNC Pin Decode	00-F4h	Decode value of SYNC pin-strap setting
31:24	UVLO Pin Decode	00-F4h	Decode value of UVLO pin-strap setting
23:16	VSET0 Pin Decode	00-F4h	Decode value of VSET0 pin-strap setting
15:8	VSET1 Pin Decode	00-F4h	Decode value of VSET1 pin-strap setting
7:0	Not Used	FF	Not used

ASCR_CONFIG (DFh)

Definition: Allows user configuration of ASCR settings. ASCR gain and residual value are automatically set by the LGA110D based on input voltage and output voltage. ASCR gain is analogous to bandwidth, ASCR residual is analogous to damping. To improve load transient response performance, increase ASCR gain. To lower transient response overshoot, increase ASCR residual. Increasing ASCR gain can result in increased PWM jitter and should be evaluated in the application circuit. Excessive ASCR gain can lead to excessive output voltage ripple. Increasing ASCR residual to improve transient response damping can result in slower recovery times, but will not affect the peak output voltage deviation. Typical ASCR gain settings range from 100 to 800, and ASCR residual settings range from 50 to 90. It is recommended to set ASCR gain to 300 and ASCR residual to 90 with recommended output capacitor in “Output Specifications” section. It is also recommended to follow “PCB layout Guideline” for stability. If customer need to reset the ASCR_CONFIG, customer need to check the stability with the new ASCR_CONFIG setting base on their application. In multi - phase condition, the ASCR setting must be set the same for all phases. For 6 phases and 8 phases, the ASCR_CONFIG is set by PMBus™ command.

Paged or Global: Paged

Data Length in Bytes: 4

Data Format: Bit Field and nonsigned binary

Type: R/W

Protectable: Yes

Default Value: ASCRCFG pin-strap setting

Units: N/A

PMBus™ SPECIFICATIONS

COMMAND	ASCR_CONFIG (DFh)							
Format	Bit Field/Linear-8 Unsigned							
Access	R/W	R/W	R/W	R/W	R/W	R/W	R/W	R/W
Bit Position	31	30	29	28	27	26	25	24
Function	See Following Table							
Default Value	0	0	0	0	0	0	0	0
Bit Position	23	22	21	20	19	18	17	16
Default Value	ASCRCFG Pin-strap Setting (residual)							
Format	Linear-16 Unsigned							
Bit Position	15	14	13	12	11	10	9	8
Function	See Following Table							
Default Value	ASCRCFG Pin-strap Setting (gain)							
Bit Position	7	6	5	4	3	2	1	0
Function	See Following Table							
Default Value	ASCRCFG Pin-strap Setting (gain)							

BIT	PURPOSE	VALUE	DESCRIPTION
31:25	Not Used	0000000h	Not used
24	ASCR Enable	1	Enable
23:16	ASCR Residual Setting	0 - 7Fh	ASCR residual
15:0	ASCR Gain Setting	0-FF	ASCR gain

PMBus™ SPECIFICATIONS

SEQUENCE (E0h)

Definition: Identifies the Rail DDC ID of the prequel and sequel rails when performing multirail sequencing. The device will enable its output when its EN or OPERATION enable state, as defined by ON_OFF_CONFIG, is set and the prequel device has issued a power-good event on the DDC bus as a result of the prequel's Power-good (PG) signal going high. The device will disable its output (using the programmed delay values) when the sequel device has issued a power-down event on the DDC bus at the completion of its ramp-down (its output voltage is 0V). The data field is a two-byte value. The most-significant byte contains the 5-bit Rail DDC ID of the prequel device. The least-significant byte contains the 5-bit Rail DDC ID of the sequel device. The most significant bit of each byte contains the enable of the prequel or sequel mode. This command overrides the corresponding sequence configuration set by the CONFIG pin settings.

Paged or Global: Paged

Data Length in Bytes: 2

Data Format: Bit Field

Type: R/W

Protectable: Yes

Default Value: 00h (prequel and sequel disabled)

Units: N/A

COMMAND	SEQUENCE (E0h)															
Format	Bit Field															
Bit Position	15	14	13	12	11	10	9	8	7	6	5	4	3	2	1	0
Access	R/W	R/W	R/W	R/W	R/W	R/W	R/W	R/W	R/W	R/W	R/W	R/W	R/W	R/W	R/W	R/W
Function	See Following Table															
Default Value	0	0	0	0	0	0	0	0	0	0	0	0	0	0	0	0

BIT	FIELD NAME	VALUE	SETTING	DESCRIPTION
15	Prequel Enable	0	DISABLE	Disable, no prequel preceding this rail
		1	ENABLE	Enable, prequel to this rail is defined by bits 12:8
14:13	Not Used	0	NOT USED	Not Used
12:8	Prequel Rail DDC ID	0-31d	DDC ID	Set to the DDC ID of the prequel rail
7	Sequel Enable	0	DISABLE	Disable, no sequel following this rail
		1	ENABLE	Enable, sequel to this rail is defined by bits 4:0
6:5	Not Used	0	NOT USED	Not used
4:0	Sequel Rail DDC ID	0-31D	DDC ID	Set to the DDC ID of the sequel rail

PMBus™ SPECIFICATIONS

DDC_GROUP (E2h)

Definition: Rails (output voltages) are assigned Group numbers in order to share specified behaviors. The DDC_GROUP command configures fault spreading group ID and enable, broadcast OPERATION group ID and enable, and broadcast VOUT_COMMAND group ID and enable. Note that DDC Groups are separate and unique from DDC Rail IDs (see “DDC_CONFIG (D3h)” section). Current sharing rails need to be in the same DDC Group in order to respond to broadcast VOUT_COMMAND and OPERATION commands. Power fail event responses (and phases) are automatically spread in Phase 0 and 1 when the LGA110D is operating in 2-phase current sharing mode when it is configured using DDC_CONFIG, regardless of its setting in DDC_GROUP.

Paged or Global: Paged

Data Length in Bytes: 34

Data Format: Bit Field

Type: R/W

Protectable: Yes

Default Value: Set by CFG pin-strap setting

Units: N/A

COMMAND	DDC_GROUP (E2h)							
Format	Bit Field							
Access	R/W	R/W	R/W	R/W	R/W	R/W	R/W	R/W
Bit Position	31	30	29	28	27	26	25	24
Function	Not Used							
Bit Position	23	22	21	20	19	18	17	16
Format	Bit Field		EN	VOUT_COMMAND Group ID				
Default Value	Set by CFG Pin-strap Setting							
Bit Position	15	14	13	12	11	10	9	8
Function	Not Used		EN	OPERATION Group ID				
Default Value	Set by CFG Pin-strap Setting							
Bit Position	7	6	5	4	3	2	1	0
Function	Not Used		EN	Power Fail Group ID				
Default Value	Set by CFG Pin-strap Setting							

PMBus™ SPECIFICATIONS

BIT	PURPOSE	VALUE	DESCRIPTION
31:22	Not Used	00	Not used
21	BROADCAST_VOUT_COMMAND response	1	Responds to broadcast VOUT_COMMAND with same Group ID
		0	Ignores broadcast VOUT_COMMAND
20:16	BROADCAST_VOUT_COMMAND group ID	0-31d	Group ID sent as data for broadcast VOUT_COMMAND events
15:14	Not Used	00	Not Used
13	BROADCAST_OPERATION response	1	Responds to broadcast OPERATION with same Group ID
		0	Ignores broadcast OPERATION
12:8	BROADCAST_OPERATION group ID	0-31d	Group ID sent as data for broadcast OPERATION events
7:6	Not Used	00	Not used
5	POWER_FAIL response	1	Responds to POWER_FAIL events with same Group ID by shutting down immediately
		0	Responds to POWER_FAIL events with same Group ID with sequenced shutdown
4:0	POWER_FAIL group ID	0-31d	Group ID sent as data for broadcast POWER_FAIL events

PMBus™ SPECIFICATIONS

MFR_IOUT_OC_FAULT_RESPONSE (E5h)

Definition: Configures the IOUT overcurrent fault response as defined by the table below. The command format is the same as the PMBus™ standard fault responses except that it sets the overcurrent status bit in STATUS_IOUT. The retry time is the time between restart attempts. It's highly recommended set as default “no retries” Advanced Energy qualified only.

Paged or Global: Paged

Data Length in Bytes: 1

Data Format: Bit Field

Type: R/W

Protectable: Yes

Default Value:80h (immediate shutdown, no retries)

Units: Retry time unit = 35mS

COMMAND	MFR_IOUT_OC_FAULT_RESPONSE (E5h)							
Format	Bit Field							
Bit Position	7	6	5	4	3	2	1	0
Access	R/W	R/W	R/W	R/W	R/W	R/W	R/W	R/W
Function	See Following Table							
Default Value	1	0	0	0	0	0	0	0

BIT	FIELD NAME	VALUE	DESCRIPTION
7:6	Response behavior, for all modes, the device: · Pulls SALRT low · Sets the related fault bit in the status registers. Fault bits are only cleared by the CLEAR_FAULTS command.	00	Not used
		01	Not used
		10	Disable without delay and retry according to the setting in bits [5:3].
		11	Output is disabled while the fault is present. Operation resumes and the output is enabled when the fault is no longer present.
5:3	Retry Setting	000	No retry. The output remains disabled until the fault is cleared.
		001-110	Not used
		111	Attempts to restart continuously, without checking if the fault is still present, until it is commanded OFF (by the CONTROL pin or OPERATION command or both), bias power is removed, or another fault condition causes the unit to shut down. The time between the start of each attempt to restart is set by the value in bits [2:0] multiplied by 35mS.
2:0	Retry Delay	000-111	Retry delay time = (Value +1)*35mS. Sets the time between retries in 35mS increments. Range is 35mS to 280mS.

PMBus™ SPECIFICATIONS

MFR_IOUT_UC_FAULT_RESPONSE (E6h)

Definition: Configures the IOUT undercurrent fault response as defined by the table below. The command format is the same as the PMBus™ standard fault responses except that it sets the undercurrent status bit in STATUS_IOUT. The retry time is the time between restart attempts. It's highly recommended set as default “no retries” Advanced Energy qualified only.

Paged or Global: Paged

Data Length in Bytes: 1

Data Format: Bit Field

Type: R/W

Protectable: Yes

Default Value:80h

Units: Retry time unit = 35mS

COMMAND	MFR_IOUT_UC_FAULT_RESPONSE (E6h)							
Format	Bit Field							
Bit Position	7	6	5	4	3	2	1	0
Access	R/W	R/W	R/W	R/W	R/W	R/W	R/W	R/W
Function	See Following Table							
Default Value	1	0	0	0	0	0	0	0

BIT	FIELD NAME	VALUE	DESCRIPTION
7:6	Response behavior, for all modes, the device: · Pulls SALRT low · Sets the related fault bit in the status registers. Fault bits are only cleared by the CLEAR_FAULTS command.	00	Not used
		01	Not used
		10	Disable without delay and retry according to the setting in bits [5:3].
		11	Output is disabled while the fault is present. Operation resumes and the output is enabled when the fault is no longer present.
5:3	Retry Setting	000	No retry. The output remains disabled until the fault is cleared.
		001-110	Not used
		111	Attempts to restart continuously, without checking if the fault is still present, until it is commanded OFF (by the CONTROL pin or OPERATION command or both), bias power is removed, or another fault condition causes the unit to shut down. The time between the start of each attempt to restart is set by the value in bits [2:0] multiplied by 35mS.
2:0	Retry Delay	000-111	Retry delay time = (Value +1)*35mS. Sets the time between retries in 35mS increments. Range is 35mS to 280mS.

PMBus™ SPECIFICATIONS

IOUT_AVG_OC_FAULT_LIMIT (E7h)

Definition: Sets the IOUT average overcurrent fault threshold. For down-slope sensing, this corresponds to the average of all the current samples taken during the (1-D) time interval, excluding the current sense blanking time (which occurs at the beginning of the 1-D interval). For up-slope sensing, this corresponds to the average of all the current samples taken during the D time interval, excluding the current sense blanking time (which occurs at the beginning of the D interval). This feature shares the OC fault bit operation (in STATUS_IOUT) and OC fault response with IOUT_OC_FAULT_LIMIT.

Paged or Global: Paged

Data Length in Bytes: 2

Data Format: Linear-11

Type: R/W

Protectable: Yes

Default Value: CFG pin-strap setting

Units: A

Equation: $IOUT_AVG_OC_FAULT_LIMIT = Y \times 2^N$

Range: 0A-35A (Refer to Table 10)

COMMAND	IOUT_AVG_OC_FAULT_LIMIT (E7h)															
Format	Linear-11															
Bit Position	15	14	13	12	11	10	9	8	7	6	5	4	3	2	1	0
Access	R/W	R/W	R/W	R/W	R/W	R/W	R/W	R/W	R/W	R/W	R/W	R/W	R/W	R/W	R/W	R/W
Function	Signed Exponent, N						Signed Mantissa, Y									
Default Value	CFG Pin-strap Setting															

PMBus™ SPECIFICATIONS

USER_GLOBAL_CONFIG (E9h)

Definition: This command is used to set options for output voltage sensing, VMON/TMON pin configuration, SMBus time-out and DDC and SYNC output configurations..

Paged or Global: Global

Data Length in Bytes: 2

Data Format: Bit Field

Type: R/W

Protectable: Yes

Default Value: Set by CFG pin-strap setting

Units: N/A

COMMAND	USER_GLOBAL_CONFIG (E9h)															
Format	Bit Field															
Bit Position	15	14	13	12	11	10	9	8	7	6	5	4	3	2	1	0
Access	R/W	R/W	R/W	R/W	R/W	R/W	R/W	R/W	R/W	R/W	R/W	R/W	R/W	R/W	R/W	R/W
Function	See Following Table															
Default Value	Set by CFG Pin-strap Setting															

BIT	FIELD NAME	VALUE	DESCRIPTION
15:13	Not Used	000000	Not used
12	VMON/TMON Config	1	READ_TEMPERATURE_3 returns TMON in °C. External 2:1 voltage divider needed on VMON/TMON pin (pin 6) to SPS TMON pin.
11:10	Not Used	00	Not used
9:8	VSENSE Select for monitoring and fault detection	00	Output 0 uses VSEN0, Output 1 uses VSEN1
		01	Both outputs use VSEN0
		10-11	Not used
7	Not Used	0	Not used
6	DDC output Configuration	0	DDC output open drain
5	Not Used	0	Not Used
4	Disable SMBus Time-Outs	0	SMBus time-outs enabled
3	Not Used	0	Not Used
2:1	Sync I/O Control	00	Use internal clock (frequency initially set with pin-strap)
		01	Use internal clock and output internal clock (not for use with pin-strap)
0	Not Used	0	Not used

PMBus™ SPECIFICATIONS

SNAPSHOT (EAh)

Definition: The SNAPSHOT command is a 32-byte read-back of parametric and status values. It allows monitoring and status data to be stored to flash either during a fault condition or via a system-defined time using the SNAPSHOT_CONTROL command. Snapshot is continuously updated in RAM and can be read using the SNAPSHOT command. When a fault occurs, the latest snapshot in RAM is stored to flash. Snapshot data can read back by writing a 01h to the SNAPSHOT_CONTROL command, then reading SNAPSHOT. Because there is a fault stored in SNAPSHOT already during Advanced Energy factory qualification test, please erase it firstly before using SNAPSHOT function.

Paged or Global: Paged

Data Length in Bytes: 32

Data Format: Bit Field

Type: Block Read

Protectable: No

Default Value: N/A

Units: N/A

BIT	VALUE	PMBus™ COMMAND	FORMAT
31:23	Not Used	Not Used	0000h
22	Flash Memory Status Byte	N/A	Bit Field
21	Manufacturer Specific Status Byte	STATUS_MFR_SPECIFIC (80h)	1 Byte Bit Field
20	CML Status Byte	STATUS_CML (7Eh)	1 Byte Bit Field
19	Temperature Status Byte	STATUS_TEMPERATURE (7Dh)	1 Byte Bit Field
18	Input Status Byte	STATUS_INPUT (7Ch)	1 Byte Bit Field
17	IOUT Status Byte	STATUS_IOUT (7Bh)	1 Byte Bit Field
16	VOUT Status Byte	STATUS_VOUT (7Ah)	1 Byte Bit Field
15:14	Switching Frequency	READ_FREQUENCY (95h)	2 Byte Linear-11
11:10	Internal Temperature	READ_TEMPERATURE_1 (8Dh)	2 Byte Linear-11
9:8	Duty Cycle	READ_DUTY_CYCLE (94h)	2 Byte Linear-11
7:6	Highest Measured Output Current	N/A	2 Byte Linear-11
5:4	Output Current	READ_IOUT (8Ch)	2 Byte Linear-11
3:2	Output Voltage	READ_VOUT (8Bh)	2 Byte Linear-16 Unsigned
1:0	Input Voltage	READ_VIN (88h)	2 Byte Linear-11

PMBus™ SPECIFICATIONS

LEGACY_FAULT_GROUP (F0h)

Definition: This command allows the LGA110D to sequence and fault spread with devices. This command sets which rail DDC IDs should be listened to for fault spreading information. The data sent is a 4-byte, 32-bit bit vector where every bit represents a rail's DDC ID. A bit set to 1 indicates a device DDC ID to which the configured device will respond upon receiving a fault spreading event. In this vector, bit 0 of byte 0 corresponds to the rail with DDC ID 0. Following through, Bit 7 of byte 3 corresponds to the rail with DDC ID 31.

NOTE: The device/rail's own DDC ID should not be set within the LEGACY_FAULT_GROUP command for that device/rail.

All devices in a current share rail must shut down for the rail to report a shutdown. If fault spread mode is enabled in USER_CONFIG, the device will immediately shut down if on of its DDC_GROUP members fail. The device/rail will attempt its configured restart only after all devices/rails within the DDC_GROUP have cleared their faults. If fault spread mode is disabled in USER_CONFIG, the device will perform a sequenced shutdown as defined by the SEQUENCE command setting. The rails/devices in a sequencing set only attempt their configured restart after all faults have cleared within the DDC_GROUP. If fault spread mode is disabled and sequencing is also disabled, the device will ignore faults from other devices and stay enabled.

Data Length in Bytes: 4

Data Format: Bit field

Type: Block R/W

Protectable: Yes

Default Value: 00000000h

Units: N/A

COMMAND	LEGACY_FAULT_GROUP (F0h)							
Format	Bit Field							
Access	R/W	R/W	R/W	R/W	R/W	R/W	R/W	R/W
Bit Position	31	30	29	28	27	26	25	24
Default Value	0	0	0	0	0	0	0	0
Bit Position	23	22	21	20	19	18	17	16
Default Value	0	0	0	0	0	0	0	0
Function	See Following Table							
Format	Bit Field							
Access	R/W	R/W	R/W	R/W	R/W	R/W	R/W	R/W
Bit Position	15	14	13	12	11	10	9	8
Default Value	0	0	0	0	0	0	0	0
Bit Position	7	6	5	4	3	2	1	0
Default Value	0	0	0	0	0	0	0	0
Function	See Following Table							

BIT	PURPOSE	SETTING	DESCRIPTION
31:0	Fault Group	00000000h	Identifies the devices in the fault spreading group.

PMBus™ SPECIFICATIONS

SNAPSHOT_CONTROL (F3h)

Definition: Writing a 01h will cause the device to copy the current SNAPSHOT values from NVRAM to the 32-byte SNAPSHOT command parameter. Writing a 02h will cause the device to write the current SNAPSHOT values to NVRAM, 03h will erase all SNAPSHOT values from NVRAM. Write (02h) and Erase (03h) may only be used when the device is disabled. All other values will be ignored. SNAPSHOT03h must be written to the device when the device is DISABLED. Data will not be updated, or written to NVRAM after a fault occurs until the SNAPSHOT 03h command has been written.

Paged or Global: Paged

Data Length in Bytes: 1

Data Format: Bit Field

Type: R/W Byte

Protectable: Yes

Default Value: 00h

Units: N/A

COMMAND	SNAPSHOT_CONTROL (F3h)							
Format	Bit Field							
Bit Position	7	6	5	4	3	2	1	0
Access	R/W	R/W	R/W	R/W	R/W	R/W	R/W	R/W
Function	See Following Table							
Default Value	0	0	0	0	0	0	0	0

BIT	DESCRIPTION
01	Read SNAPSHOT values from NVRAM
02	Write SNAPSHOT values to NVRAM
03	Erase SNAPSHOT values from NVRAM

RESTORE_FACTORY (F4h)

Definition: Restores the device to the hard-coded factory default values and pin-strap definitions. The device retains the DEFAULT and USER stores for restoring. Security level is changed to Level 1 following this command.

Paged or Global: Global

Data Length in Bytes: 0

Data Format: N/A

Type: Write Only

Protectable: Yes

Default Value: N/A

Units: N/A

PMBus™ SPECIFICATIONS

MFR_VMON_OV_FAULT_LIMIT (F5h)

Definition: Sets the VMON over-temperature fault threshold. The VMON overvoltage warn limit is automatically set to 90% of this fault value. If VMON is not used, set VMON_OV_FAULT_RESPONSE to 00h, which will disable VMON OV faults entirely.

Paged or Global: Global

Data Length in Bytes: 2

Data Format: Linear-11

Type: R/W

Protectable: Yes

Default Value: C266h (2.4V)

Units: Volts

Equation: $MFR_VMON_OV_FAULT_LIMIT = Y \times 2^N$

Range: 0 to 20V

COMMAND	MFR_VMON_OV_FAULT_LIMIT (F5h)															
Format	Linear-11															
Bit Position	15	14	13	12	11	10	9	8	7	6	5	4	3	2	1	0
Access	R/W	R/W	R/W	R/W	R/W	R/W	R/W	R/W	R/W	R/W	R/W	R/W	R/W	R/W	R/W	R/W
Function	Signed Exponent, N					Signed Mantissa, Y										
Default Value	1	1	1	0	0	0	1	0	0	1	1	0	0	1	1	0

MFR_VMON_UV_FAULT_LIMIT (F6h)

Definition: Sets the VMON under voltage fault threshold. The VMON undervoltage warn limit is automatically set to 110% of this fault value. If VMON is not used, set VMON_UV_FAULT_RESPONSE to 00h, which will disable VMON UV faults entirely.

Paged or Global: Global

Data Length in Bytes: 2

Data Format: Linear-11

Type: R/W

Protectable: Yes

Default Value: 9B33h (0.1V)

Units: Volts

Equation: $MFR_VMON_UV_FAULT_LIMIT = Y \times 2^N$

Range: 0 to 20V

PMBus™ SPECIFICATIONS

COMMAND	MFR_VMON_UV_FAULT_LIMIT (F6h)															
Format	Linear-11															
Bit Position	15	14	13	12	11	10	9	8	7	6	5	4	3	2	1	0
Access	R/W	R/W	R/W	R/W	R/W	R/W	R/W	R/W	R/W	R/W	R/W	R/W	R/W	R/W	R/W	R/W
Function	Signed Exponent, N					Signed Mantissa, Y										
Default Value	1	0	1	1	0	0	0	0	1	1	0	0	1	1	0	0

MFR_READ_VMON (F7h)

Definition: Reads the voltage on the VMON pin.

Paged or Global: Global

Data Length in Bytes: 2

Data Format: Linear-11

Type: Read Only

Protectable: No

Default Value: N/A

Units: °C

Equation: $MFR_READ_VMON = Y \times 2^N$

Range: -200°C to +200°C

COMMAND	MFR_READ_VMON (F7h)															
Format	Linear-11															
Bit Position	15	14	13	12	11	10	9	8	7	6	5	4	3	2	1	0
Access	R/W	R/W	R/W	R/W	R/W	R/W	R/W	R/W	R/W	R/W	R/W	R/W	R/W	R/W	R/W	R/W
Function	Signed Exponent, N					Signed Mantissa, Y										
Default Value	NA	NA	NA	NA	NA	NA	NA	NA	NA	NA	NA	NA	NA	NA	NA	NA

VMON_OV_FAULT_RESPONSE (F8h)

Definition: Configures the VMON overvoltage fault response as defined by the table below. Note: The retry time is the time between restart attempts. If VMON is not used, set this response to 00h, which will disable VMON OV faults entirely.

Paged or Global: Global

Data Length in Bytes: 1

Data Format: Bit Field

Type: R/W

Protectable: Yes

Default Value: BFh (continuous retries)

Units: N/A

PMBus™ SPECIFICATIONS

COMMAND	VMON_OV_FAULT_RESPONSE (F8h)							
Format	Bit Field							
Bit Position	7	6	5	4	3	2	1	0
Access	R/W	R/W	R/W	R/W	R/W	R/W	R/W	R/W
Function	See Following Table							
Default Value	1	0	1	1	1	1	1	1

BIT	FIELD NAME	VALUE	DESCRIPTION
7:6	Response behavior, the device: · Pulls SALRT low · Sets the related fault bit in the status registers. Fault bits are only cleared by the CLEAR_FAULTS command.	00	Ignore faults
		01	Not used
		10	Disable without delay and retry according to the setting in bits [5:3].
		11	Output is disabled while the fault is present. Operation resumes and the output is enabled when the fault is no longer present.
5:3	Retry Setting	000	No retry. The output remains disabled until the fault is cleared.
		001-110	Not used
		111	Attempts to restart continuously, without checking if the fault is still present, until it is commanded OFF (by the CONTROL pin or OPERATION command or both), bias power is removed, or another fault condition causes the unit to shut down. A retry is attempted after VMON falls below 95% of the VMON_OV_FAULT_LIMIT. The time between the start of each attempt to restart is set by the value in bits [2:0] multiplied by 35mS.
2:0	Retry Delay	000-111	Retry delay time = (Value +1)*35mS. Sets the time between retries in 35mS increments. Range is 35mS to 280mS.

PMBus™ SPECIFICATIONS

VMON_UV_FAULT_RESPONSE (F9h)

Definition: Configures the VMON under voltage fault response as defined by the table below. Note: The retry time is the time between restart attempts. If VMON is not used, set this response to 00h, which will disable VMON UV faults entirely

Paged or Global: Global

Data Length in Bytes: 1

Data Format: Bit Field

Type: R/W

Protectable: Yes

Default Value: BFh (continuous retries)

Units: Retry time unit = 35mS

COMMAND	VMON_UV_FAULT_RESPONSE (F9h)							
Format	Bit Field							
Bit Position	7	6	5	4	3	2	1	0
Access	R/W	R/W	R/W	R/W	R/W	R/W	R/W	R/W
Function	See Following Table							
Default Value	1	0	1	1	1	1	1	1

BIT	FIELD NAME	VALUE	DESCRIPTION
7:6	Response behavior, the device: · Pulls SALRT low · Sets the related fault bit in the status registers. Fault bits are only cleared by the CLEAR_FAULTS command.	00	Ignore faults
		01	Not used
		10	Disable without delay and retry according to the setting in bits [5:3].
		11	Output is disabled while the fault is present. Operation resumes and the output is enabled when the fault is no longer present.
5:3	Retry Setting	000	No retry. The output remains disabled until the fault is cleared.
		001-110	Not used
		111	Attempts to restart continuously, without checking if the fault is still present, until it is commanded OFF (by the CONTROL pin or OPERATION command or both), bias power is removed, or another fault condition causes the unit to shut down. A retry is attempted after VMON falls below 95% of the VMON_OV_FAULT_LIMIT. The time between the start of each attempt to restart is set by the value in bits [2:0] multiplied by 35mS.
2:0	Retry Delay	000-111	Retry delay time = (Value +1)*35mS. Sets the time between retries in 35mS increments. Range is 35mS to 280mS.

PMBus™ SPECIFICATIONS

SECURITY_LEVEL (FAh)

Definition: The device provides write protection for individual commands. Each bit in the UNPROTECT parameter controls whether its corresponding command is writeable (commands are always readable). If a command is not writeable, a password must be entered in order to change its parameter (i.e., to enable writes to that command). There are two types of passwords, public and private. The public password provides a simple lock-and-key protection against accidental changes to the device. It would typically be sent to the device in the application prior to making changes. Private passwords allow commands marked as no writeable in the UNPROTECT parameter to be changed. Private passwords are intended for protecting default-installed configurations and would not typically be used in the application. Each store (USER and DEFAULT) can have its own UNPROTECT string and private password. If a command is marked as no writeable in the DEFAULT UNPROTECT parameter (its corresponding bit is cleared), the private password in the DEFAULT store must be sent in order to change that command. If a command is writeable according to the default UNPROTECT parameter, it may still be marked as non-writeable in the user store UNPROTECT parameter. In this case, the user private password can be sent to make the command writeable. The device supports four levels of security. Each level is designed to be used by a particular class of users, ranging from module manufacturers to end users, as discussed below. Levels 0 and 1 correspond to the public password. All other levels require a private password. Writing a private password can only raise the security level. Writing a public password will reset the level down to 0 or 1.

Figure 54 shows the algorithm used by the device to determine if a particular command write is allowed.

Paged or Global: Global

Data Length in Bytes: 1

Data Format: Hex

Type: Read Byte

Protectable: No

Default Value: 01h

Units: N/A

LGA110D set security level to 1 that protect Advanced Energy default settings via a password.

User can save their settings in user store via PMBus™ command STORE_USER_ALL that is in effect on LGA110D.

User cannot overwrite Advanced Energy's default settings without correct password.

User can restore to Advanced Energy's default settings via send below PMBus™ commands one by one, after recycle V_{IN} , LGA110D settings are back to Advanced Energy's default settings.

- 1.PRIVATE_PASSWORD (send null string 000000000000000000h)
- 2.RESTORE_FACTORY
- 3.PRIVATE_PASSWORD (send null string 000000000000000000h)
- 4.STORE_USER_ALL
- 5.Recycle V_{IN}

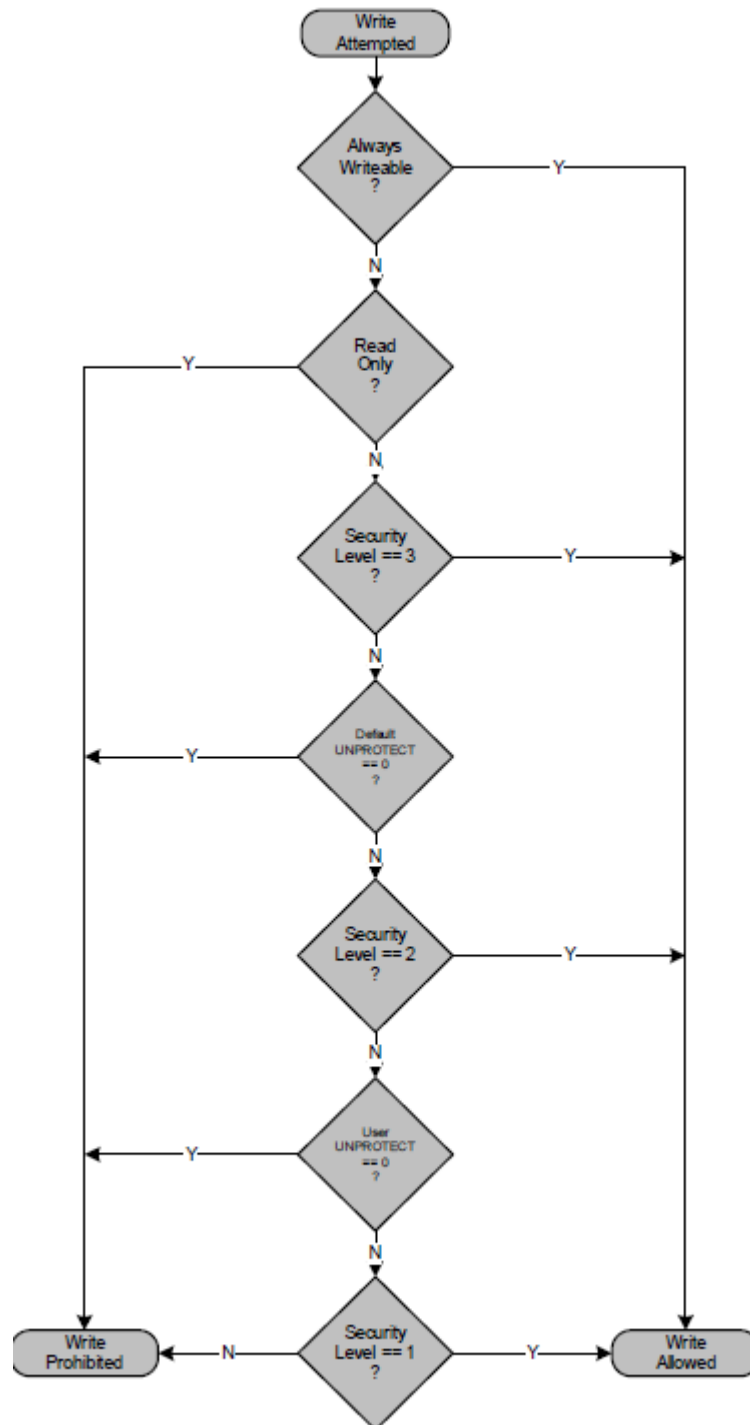

Figure 54 ALGORITHM USED TO DETERMINE WHEN A COMMAND IS WRITEABLE

PMBus™ SPECIFICATIONS

Security Level 3 - Module Vendor

Level 3 is intended primarily for use by module vendors to protect device configurations in the default store. Clearing a UNPROTECT bit in the default store implies that a command is writeable only at Level 3 and above. The device's security level is raised to Level 3 by writing the private password value previously stored in the default store. To be effective, the module vendor must clear the UNPROTECT bit corresponding to the STORE_DEFAULT_ALL and RESTORE_DEFAULT commands. Otherwise, Level 3 protection is ineffective since the entire store could be replaced by the user, including the enclosed private password.

Security Level 2 - User

Level 2 is intended for use by the end user of the device. Clearing a UNPROTECT bit in the user store implies that a command is writeable only at Level 2 and above. The device's security level is raised to Level 2 by writing the private password value previously stored in the User Store. To be effective, the user must clear the UNPROTECT bit corresponding to the STORE_USER_ALL, RESTORE_DEFAULT_ALL, STORE_DEFAULT_ALL and RESTORE_DEFAULT commands. Otherwise, Level 2 protection is ineffective since the entire store could be replaced, including the enclosed private password.

Security Level 1 - Public

Level 1 is intended to protect against accidental changes to ordinary commands by providing a global write-enable. It can be used to protect the device from erroneous bus operations. It provides access to commands whose UNPROTECT bit is set in both the default and User Store. Security is raised to Level 1 by writing the public password stored in the user store using the PUBLIC_PASSWORD command. The public password stored in the default store has no effect.

Security Level 0 - Unprotected

Level 0 implies that only commands which are always writeable (e.g., PUBLIC_PASSWORD) are available. This represents the lowest authority level and hence the most protected state of the device. The level can be reduced to 0 by using PUBLIC_PASSWORD to write any value which does not match the stored public password.

PMBus™ SPECIFICATIONS

PRIVATE_PASSWORD (FBh)

Definition: Sets the private password string.

Paged or Global: Global

Data Length in Bytes: 9

Data Format: ASCII. ISO/IEC 8859-1

Type: Block R/W

Protectable: No

Default Value: 000000000000000000h

Units: N/A

PUBLIC_PASSWORD (FCh)

Definition: Sets the public password string.

Paged or Global: Global

Data Length in Bytes: 4

Data Format: ASCII. ISO/IEC 8859-1

Type: Block R/W

Protectable: No

Default Value: 00000000h

Units: N/A

APPLICATION NOTES

Electrical Description

The LGA110D is designed with a voltage mode dual-phase synchronous buck topology and the block diagram is shown in Figure 55.

The output voltage is adjustable over a range of 0.6 - 5 V by using an external resistor or 0.5V – 5V by PMBus™.

The POL module can be shut down via the ON/OFF input pin. The module is enabled when the ON/OFF pin is in logic high, and disabled when it is in logic low.

The power good signal is an pull up output that is pulled low by the PWM controller when it detects the output exceeded $\pm 10\%$ of the set value.

The output is monitored for over current and short-circuit conditions. When the PWM controller detects an over current condition, it forces the module into the defaulted latch mode.

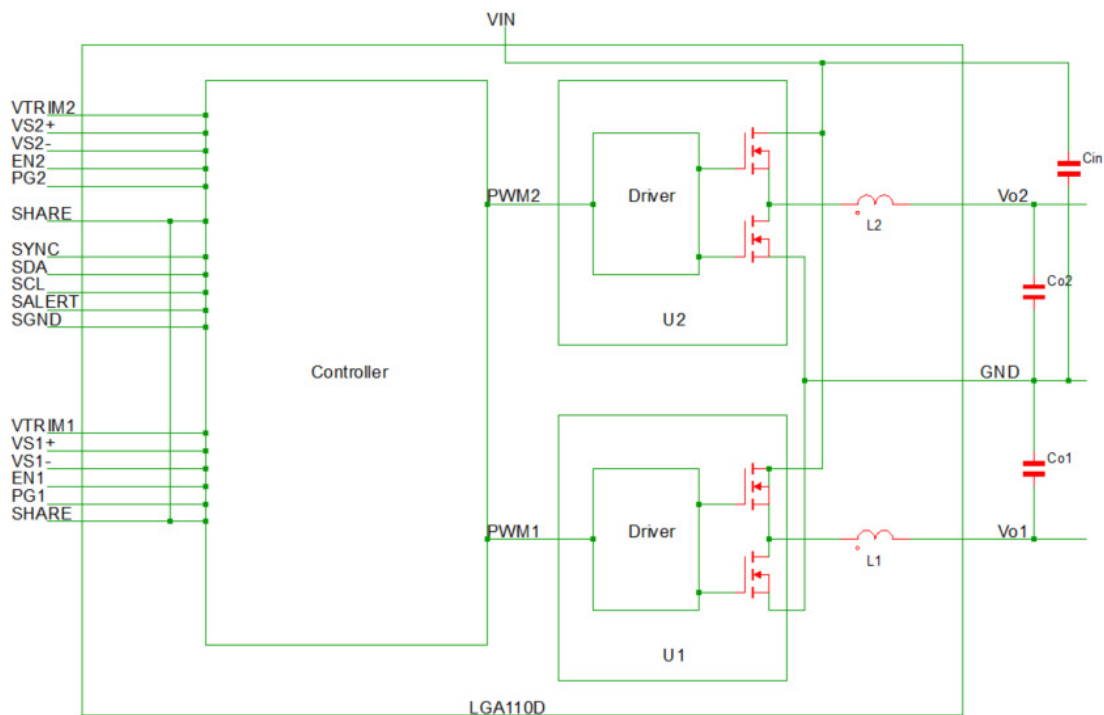

Figure 55: Electrical Block Diagram

Wide Operating Temperature Range

The LGA110D's ability to accommodate a wide range of ambient temperatures is the result of its extremely high power conversion efficiency and resultant low power dissipation, combined with the excellent thermal management within the unit means that it can cover a vast array of applications.

APPLICATION NOTES

Typical Applications

The LGA110D has a lot of applications. Below are some typical applications:

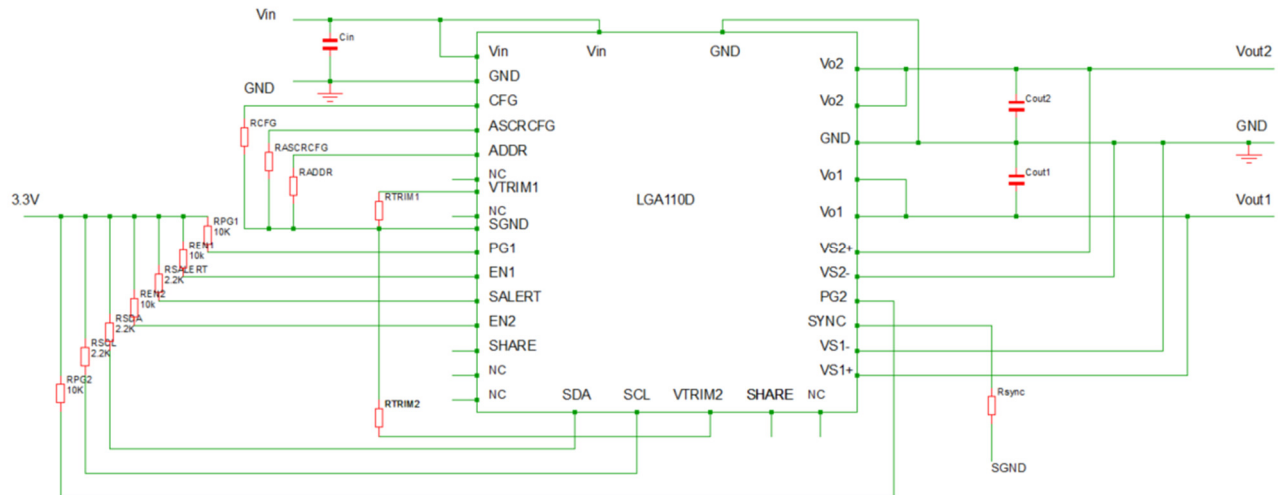

Figure 56: Standard Application (dual output)

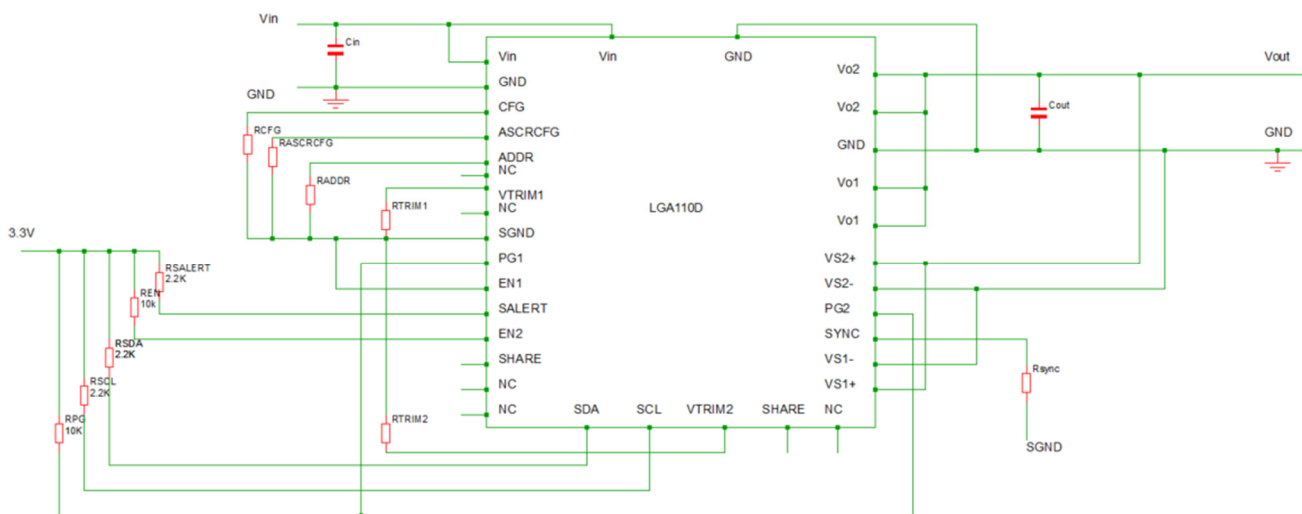

Figure 57: One module one output

APPLICATION NOTES

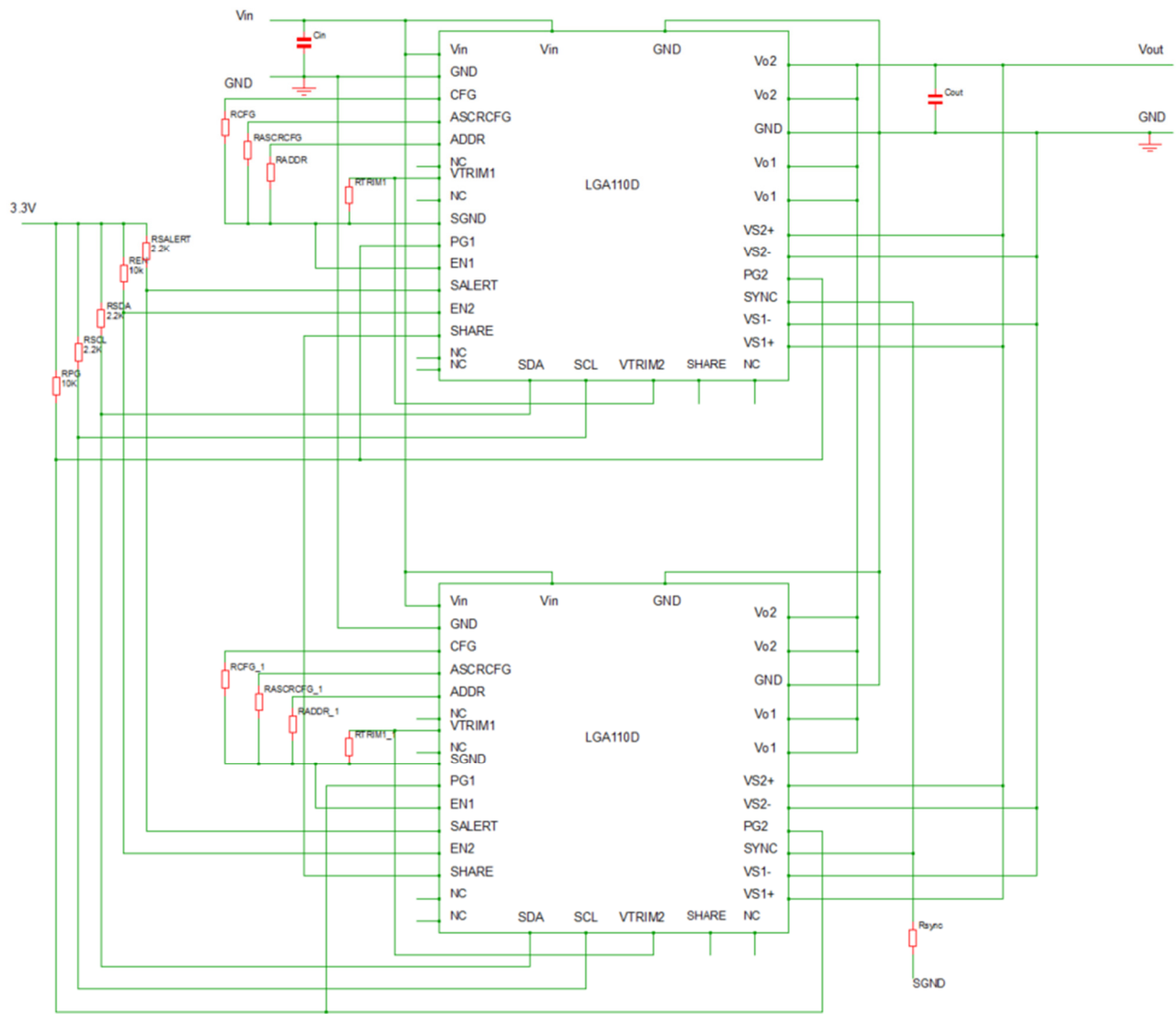
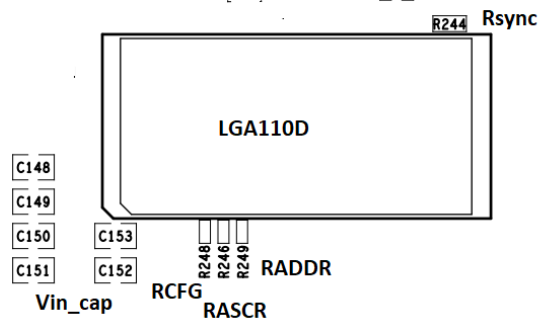

Figure 59: Two modules one output

APPLICATION NOTES

PCB layout Guideline

1. All the pin strapped resistors, RSYNC, RADDR, RASCR, RVtrim, RCFG, should be placed as close to the LGA110D module pins as possible to minimize loops that may pick up noise. The connection from the Vtrim pin, to the Vtrim resistor, back to SGND must be as short as possible. It is recommended the path including the resistor body should less than 10mm.



2. The output capacitors should be placed as close to the LGA110D module pins as possible to minimize the output impedance. The output capacitors should also be placed close to the remote sense point for stability.
3. The input ceramic capacitors should be placed as close to the LGA110D module pins as possible to decouple noise.
4. The LGA110D POL modules should be placed closely to the ASIC for better performance. Since the overshoot voltage during step is followed $V=L*di/dt$, the L is the PCB power trace inductance, if PCB impedance is high, the overshoot voltage may be high.
5. Remote sense VS+, VS- traces should be in paralleled connect to output, the traces are shield by GND to minimized noise couple. Recommended connect VS+/VS- to one high capacitance output capacitor's soldering pads that is close to actual load, please do not connect VS+/VS- very close to LGA110D output pins that is high ripple noise cause control loop unstable.

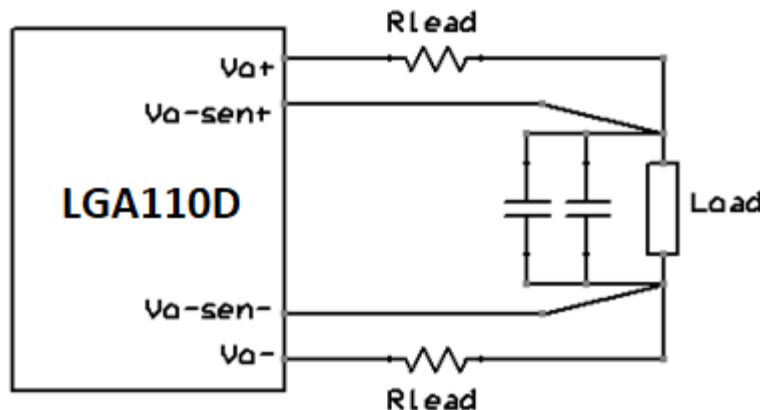

6. Full hole vias are very helpful for lower impedance and better thermal conductivity. Recommended add 12pcs full hole vias on each power pin soldering pad if possible, such as Vin, Vo, GND. Recommended add 3pcs full hole vias on each soldering pad of output polymer Tan capacitor, add 2pcs full hole vias on each soldering pad of output ceramic capacitor. Even for signal pins, more full hole vias on soldering pads shall improve thermal conductivity that cool down the LGA110D module as well.

APPLICATION NOTES

Output Voltage Adjustment

The output voltage is adjustable from 0.5V to 5V. The outputs can be adjusted with an external resistor placed between the “Vtrim1 or Vtrim2” and “GND” pin shown Figure 60. Vo1 and Vo2 can also be set by PMBus™ command. VOUT_MAX is also determined by this pin-strap setting, and is 15% greater than the V_{trim0} and V_{trim1} voltage settings by default, however VOUT_MAX can be changed via the PMBus™.

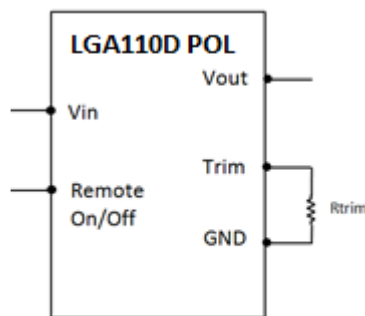

Figure 60: Output Voltage Adjustment

RVSET(Kohm)	VOUT(V)	RVSET(Kohm)	VOUT(V)
LOW	1	38.3	1.3
OPEN	1.2	42.2	1.4
HIGH	0.9	46.4	1.5
10	0.6	51.1	1.6
11	0.65	56.2	1.7
12.1	0.7	61.9	1.8
13.3	0.75	68.1	1.9
14.7	0.8	75	2.0
16.2	0.85	82.5	2.1
17.8	0.9	90.9	2.2
19.6	0.95	100	2.3
21.5	1	110	2.5
23.7	1.05	121	2.8
26.1	1.1	133	3.0
28.7	1.15	147	3.3
31.6	1.2	162	4.0
34.8	1.25	178	5.0

APPLICATION NOTES

Module Address Selection

When communicating with multiple SMBus modules using the SMBus interface, each module must have its own unique address so the host can distinguish between the modules. The module address can be set according to the pin-strap options listed in the table. When operating in 2 output mode, care must be taken when using sequential PMBus™ addresses. Since share addresses are automatically set using the PMBus™ address, it is possible for a module with a PMBus™ address immediately after a 2 output LGA110D module to be automatically configured with the same share address as one of the LGA110D channels, which could cause unintended operating modes. When using the LGA110D in a 4-phase application, the master device address must be 1 higher than the slave address. For this reason, do not use the next higher PMBus™ address when using the LGA110D as a 2 output module. The SMBus address cannot be changed with a PMBus™ command.

Table 8. Module Address Selection Reference:

RSA(Kohm)	SMBus ADDRESS	RSA(Kohm)	SMBus ADDRESS
LOW	40h	42.2	51h
OPEN	42h	46.4	52h
10	41h	51.1	53h
11	43h	56.2	54h
12.1	44h	61.9	55h
13.3	45h	68.1	56h
14.7	46h	75	57h
16.2	47h	82.5	58h
17.8	48h	90.9	59h
19.6	49h	100	5Ah
21.5	4Ah	110	5Bh
23.7	61h	121	5Ch
26.1	4Ch	133	5Dh
28.7	4Dh	147	5Eh
31.6	4Eh	162	5Fh
34.8	4Fh	178	60h
38.3	50h		

APPLICATION NOTES

Switching Frequency Setting (SYNC)

The LGA110D switching frequency can be set from 533kHz to 800kHz by using the pin-strap method as shown in Table 9, or by using a PMBus™ command.

The LGA110D incorporates an internal phase-locked loop (PLL) to clock the internal circuitry. The PLL can be driven by an external clock source connected to the SYNC pin. When using the internal oscillator, the SYNC pin can be configured as a clock source. By default, the SYNC pin is configured as an input. The LGA110D will automatically check for a clock signal on the SYNC pin each time EN is asserted. The LGA110D will then synchronize with the rising edge of the external clock.

The incoming clock signal must be in the range of 533kHz to 800kHz and must be stable when the EN pin (EN1,EN2) is asserted. When using an external clock, the frequencies are not limited to discrete values as when using the internal clock. The external clock signal must not vary more than 10% from its initial value, and should have a minimum pulse width of 150ns. In the event of a loss of the external clock signal, the output voltage may show transient over shoot or undershoot. If loss of synchronization occurs, the LGA110D will automatically switch to its internal oscillator and switch at its programmed frequency.

The SYNC pin can also be configured as an output. The module will run from its internal oscillator and will drive the SYNC pin so other modules can be synchronized to it. The SYNC pin will not be checked for an incoming clock signal while in this mode. The switching frequency can be set to any value between 533kHz to 800kHz using a PMBus™ command. The available frequencies below 800kHz are defined by $f_{SW} = 16\text{MHz}/N$, where $20 \leq N \leq 30$.

If a value other than $f_{SW} = 16\text{MHz}/N$ is entered using a PMBus™ command, the internal circuitry will select the switching frequency value using N as a whole number to achieve a value close to the entered value. For example, if 810kHz is entered, the module will select 800kHz (N=20).

Table 9. Switching Frequency Setting Reference:

RSYNC (Kohm)	FREQ (kHz)
26.1	533
28.7	571
31.6	615
34.8	727
38.3	800

APPLICATION NOTES

EN

EN are used to enable and disable each channel of the LGA110D. The enable pins should be held low whenever a configuration file or script is used to configure the LGA110D, or a PMBus™ command is sent that could potentially damage the application circuit. When the LGA110D is used in a self-enabled mode, for example, when EN1 or EN2 is tied to an external 5Vcc or a resistor divider to V_{IN} , the user must consider the LGA110D's default factory settings. When a configuration file is used to configure the LGA110D, the factory default settings are restored to both the user and default stores in order to set the LGA110D to an initialized state. Since the default state of the LGA110D is to be enabled when the enable pin is high, it is possible for the LGA110D to be enabled while the PMBus™ commands are sent to the LGA110D during the configuration process and is defaulted as open drain.

The Enable pin is edge triggered to achieve fast turn-off times. As a result, minimum Enable high and Enable low pulse widths must be observed to ensure correct operation. The minimum high and low pulse widths are dependent on the configured rise, fall and delay times and can be calculated using Equations 1 and 2:

$$\text{EN low} > \text{TOFF_DELAY} + \text{TOFF_FALL} + 10.5\text{mS} \quad (\text{EQ.1})$$

$$\text{EN high} > \text{TON_DELAY} + \text{TON_RISE} + \text{POWER_GOOD_DELAY} + 5.5\text{mS} \quad (\text{EQ.2})$$

EN low and EN high times shorter than these minimums may result in the device not responding to the trailing edge of the pulse. For example, a EN low pulse below the EN low minimum pulse width may stay in the OFF state until a valid EN low pulse is applied to the EN pin.

The enable signal must be a clean signal with no bouncing. If a physical switch is to be used for enable of the LGA110D, a debounce circuit must be used to ensure EQ.1 and EQ.2 are met.

Power Good

The LGA110D provides a power good signal (PG1, PG2) for each channel that indicates the output voltage is within a specified tolerance of its target level and no fault condition exists. By default, the PG pin will assert if the output is within 10% of the target voltage.

Digital Bus (Share)

The Digital-DC Communications (Share) bus is used to communicate between modules, and within the LGA110D itself.

This dedicated bus provides the communication channel between modules for features such as sequencing, fault spreading, and current sharing.

The share pin on all Digital-DC modules that utilize sequencing, fault spreading or current sharing must be connected together. The share pin on all Digital-DC modules in an application should be connected together.

Stackable

When multiple point of load converters share a common DC input supply, it is desirable to adjust the clock phase offset of each module such that not all modules have coincident rising edges. Setting each converter to start its switching cycle at a different point in time can dramatically reduce input capacitance requirements. Since the peak current drawn from the input supply is effectively spread out over a period of time, the peak current drawn at any given moment is reduced and the power losses are reduced.

In order to enable stackable feature, all converters must be synchronized to the same switching clock. Configuring the SYNC pin is described in the Configurable Pins Section of this document.

User can set 6 or 8 phases configuration either by Advanced Energy GUI or PMBus™ commands. Please contact Advanced Energy to get 6 or 8 phases setting instruction.

APPLICATION NOTES

Fault Spreading

The Digital POL modules can be configured to broadcast a fault event over the share bus to the other modules in the group. When a fault occurs and the module is configured to shut down on a fault, the module will shut down and broadcast the fault event over the share bus. The other modules on the share bus will shut down together if configured to do so, and will attempt to re-start in their prescribed order if configured to do so.

Active Current Sharing

The PWM outputs of the LGA110D are used in parallel to create a dual phase power rail. The module outputs will share the current equally within a few percent, assuming all external sensing element variations and tolerances are negligible.

Start-up and Shut-down Delay Characteristics

The LGA110D follows a specific internal start-up procedure after power is applied to the VDD pin, as shown in below Figure 61.

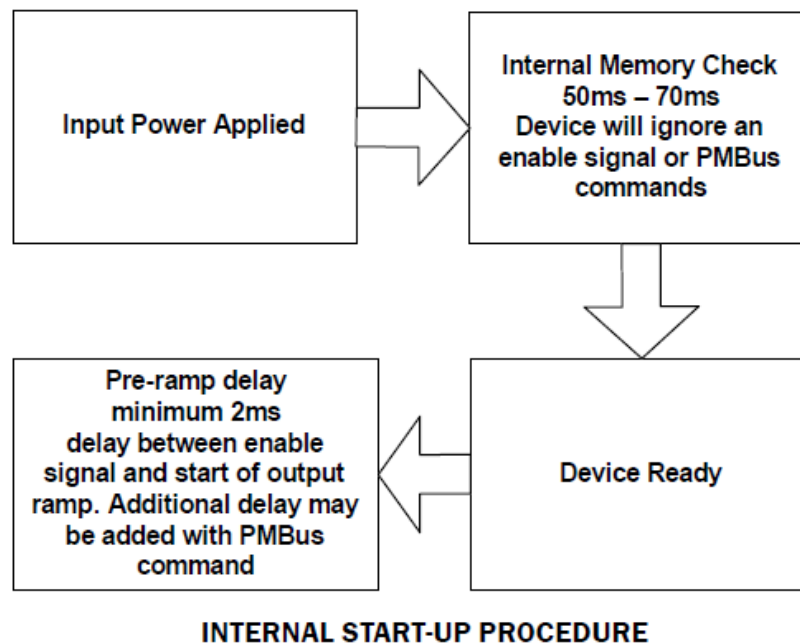

Figure 61: Start-Up Procedure

The device requires approximately 60 mS to check for specific values stored in its internal memory. If the user has stored values in memory, those values will be loaded. When this process is completed, the device is ready to accept commands through the serial interface and the device is ready to be enabled. If the device is to be synchronized to an external clock source, the clock frequency must be stable before asserting the EN pin. When enabled, the device requires approximately 2mS before its output voltage will be allowed to start its ramp-up process.

Suggest Enable pin held low for more than 110 mS during the initial application of power.

APPLICATION NOTES

After the Ton-delay period has expired, the output will begin to ramp towards its target voltage according to the preconfigured Ton-rise time.

VIN should be above the LGA110D's UVLO limit (VIN_UV_FAULT_LIMIT) before the Enable pin is driven high.

Following this sequence will result in the most consistent turn-on delays. If a configuration file is needed to ensure proper circuit operation, when VIN is first applied to the LGA110D, for example, during initial PCB turn-on and test, the Enable pin must be held low by some means until the LGA110D configuration file can be loaded. If the Enable pin is not held low, then the LGA110D may attempt to turn on with incorrect configuration settings, possibly causing circuit failure. In those cases in which a configuration file is needed to ensure proper circuit operation and the Enable pin cannot be held low during the initial application of power, two options are available:

- Limit VIN to 3.0V during initial testing. The LGA110D configuration file can be loaded when VIN is as low as 3.0V.

When the configuration file is loaded VIN can be increased to the normal input voltage range.

T-ON delay

The default T-on delay for the LGA110D in 2 outputs configuration on LGA110D is

EN1	5mS
EN2	10mS

There is a minimum of 2mS pre-ramp delay between the enable signal and the start of the output voltage ramp. The T-on delay should be set higher than 2mS.

As the controller program is running for individual channel control, it is not able to ensure whether it reads EN1 status or EN2 status first. The turn-on sequencing between EN1 and EN2 can't be guaranteed for the same Ton delay. Therefore the delay is set on both EN1 and EN2 channels. With this setting, the controller can ensure the timing and sequencing on Vo1 and Vo2.

If an application demands both of Vo1 and Vo2 to reach the regulated point at the same time, it is recommended to compensate for this off-set in time by setting Ton rise time appropriately instead of Ton delay.

For reference:

Typical total delays at Vo1 = Ton delays from EN1 + Ton rise delays = 5mS + 10mS =15mS typical

Typical total delays at Vo2 = Ton delays from EN2 + Ton rise delays = 10mS + 5mS =15mS typical

T-OFF delay

During the shut-down of the converter, the controller doesn't need to wait for the preparation of the reference ramp. The propagation delay from Enable signal to PWM off is very small, and Vout can almost follow the T-off delay setting to turn off the output. However, note that the controller is not able to ensure whether it reads EN1 status or EN2 status first, and therefore there if the unit is used in 2 output configuration, there will be a delay in Enable OFF between two channel outputs. The delay between the two channels is 0.1mS typical.

APPLICATION NOTES

Configuration Setting (CFG)

The Configuration pin (CFG) sets several module configuration settings allowing the module to be used in applications without the need for loading configuration files. The settings are shown in Table 10. This must be done in order for the 2 modules to be recognized as part of a current sharing group.

Table 10. Configuration Setting Reference^{1,2}

RCFG(Kohm)	Phase2	Phase1	CIRCUIT
	AVERAGE OC LIMIT (A)	AVERAGE OC LIMIT (A)	
10	25	25	2 Output
11	35	35	2 Output
12.1	45	45	2 Output
13.3	55	55	2 Output
14.7	60	60	2 Output
16.2	65	65	2 output
56.2	25	25	2-Phase
61.9	35	35	2-Phase
68.1	45	45	2-Phase
75	55	55	2-Phase
82.5	65	65	2-Phase
90.9	35	35	4-PH Master
100	35	35	4-PH Slave
110	45	45	4-PH Master
121	45	45	4-PH Slave
133	55	55	4-PH Master
147	55	55	4-PH Slave
162	65	65	4-PH Master
178	65	65	4-PH Slave
LOW	20	20	2-Phase
OPEN	20	20	2 Output
HIGH	35	35	2 Output

Note 1 - The OC limit in above table is for each phase only. If the application is 2/4/6/8 phase, shall be multiplied 2/4/6/8 as OC limit. For example, in 4 phase application, if set RCFG=90.9Kohm, the average OC limit for 4 phase application is 4 x 35 =140A.

Note 2 - In 2 outputs application, phase1 means Vo1, phase2 means Vo2.

APPLICATION NOTES

Charge Mode Control (ASCR) Setting(ASCRCFG)

The module's Charge Mode response can be optimized by adjusting the ASCR Gain and Residual settings by using the ASCR_CONFIG PMBus™ command or external resistor between ASCR and GND. The resistor setting is followed Table 11.

Table 11. Charge Mode Control Setting Reference

ASCRCFG(Kohm)	GAIN Phase2	GAIN Phase1
10	200	200
17.8	400	400
31.6	600	600
56.2	800	800
110	100	100
121	300	300
133	500	500
147	700	700
LOW	300	300
OPEN	500	500
HIGH	700	700

Note - ASCR gain must be set to same value of each phase at 2,4,6,8 phase application.

APPLICATION NOTES

Multi Phase

Extra commands are required for 4, 6 or 8 phase application. Table 12 and Table 13 is an example for 8 phase commands setting. Advanced Energy qualified $V_{IN} = 12V$ for 8 phase application only.

Table 12. Command setting for 8 phase (TBC)

	Command Name	Master module	Slave module 1	Slave module 2	Slave module 3
Global	USER_GLOBAL_CONFIG	0x1102	0x1104	0x1104	0x1104
Page 0	DDC_CONFIG	0x0007	0x2007	0x4007	0x6007
	DDC_GROUP	0x00202000	0x00202000	0x00202000	0x00202000
	VOUT_DROOP	Table 13			
	MULTI_PHASE_RAM_P_GAIN				
Page 1	DDC_CONFIG	0x8007	0xA007	0xC007	0xE007
	DDC_GROUP	0x00202000	0x00202000	0x00202000	0x00202000
	VOUT_DROOP	Table 13			
	MULTI_PHASE_RAM_P_GAIN				

Table 13. Recommended Vout_Droop and MULTI_PHASE_RAMP_GAIN setting for 8 Phase (TBC)

Vout (V)	Vout Droop	MULTI_PHASE_RAMP_GAIN
0.5	0.1 (0x9B33)	3 (0x03)
1	0.1 (0x9B33)	3 (0x03)
1.8	0.1 (0x9B33)	7(0x07)
2.5	0.13 (0xA214)	10(0x0A)
3.3	0.13 (0xA214)	15(0x0F)
5	0.13 (0xA214)	15(0x0F)

APPLICATION NOTES

Multi Phase – Current derating at low temperature (TBC)

For 4, 6 or 8 Phase, current derating is required at low temperature. Refer to Table 14.

Table 14. 4, 6 or 8 Phase current derating table at low temperature (TBC)

	-20 °C	-40 °C
Vout (V)	Max Iout (per phase)	Max Iout (per phase)
0.5	55	55
1	55	55
1.8	50	50
2.5	45	45
3.3	40	40
5	35	35

APPLICATION NOTES

Surface Mount Information

Pick and Place

The LGA110D is designed with certain features to ensure it is compatible with standard pick and place equipment. The low mass of typically 9 grams is within the capability of standard pick and place equipment. The choice of nozzle size and style and placement speed may need to be optimized.

The inductor has a flat area of 133.2mm² (0.206in²) that can be used as a pick-up area.

PC Board Assembly Side

LGA110D module is not recommended for assembly on the bottom side of a customer board. If such an assembly is attempted, components may fall off the module during the second reflow process.

Moisture Sensitivity Level (MSL)

This module is classified as MSL level 3.

Storage and Handling

The recommended storage environment and handling procedures for moisture-sensitive surface mount packages is detailed in J-STD-033 (Handling, Packing, Shipping and Use of Moisture/Reflow Sensitive Surface Mount Devices). Moisture barrier bags (MBB) with desiccant are required for MSL ratings of 2 or greater. These sealed packages should not be broken until time of use. Once the original package is broken, the floor life of the product at conditions of $\leq 30^{\circ}\text{C}$ and 60% relative humidity varies according to the MSL rating (See J-STD-033). The shelf life for dry packed SMT packages will be a minimum of 12 months from the bag seal date, when stored at the following conditions: $<40^{\circ}\text{C}$, $<90\%$ relative humidity.

Post Soldering Cleaning

Post solder cleaning is not recommended because it may affect the reliability of module.

APPLICATION NOTES

Pb-free Reflow Profile

This module will comply with IPC/JEDEC J-STD-020 (Moisture/Reflow Sensitivity Classification for Nonhermetic Solid State Surface Mount Devices) for both Pb-free solder profiles and MSL classification procedures. The Standard provides reflow profile based on the volume and thickness of the module. The suggested Pb-free solder paste is Sn/Ag/Cu (SAC305). The recommended reflow temperature profile using SAC305 solder is shown below.

Tin-Pb Reflow Profile

The power modules are lead free modules and can be soldered either in a lead-free solder process or in a conventional Tin/Lead (Sn/Pb) process. It is recommended that the customer review datasheets in order to customize the solder reflow profile for each load board assembly. The following instructions must be observed when soldering these units. Failure to observe these instructions may result in the failure of or cause damage to the modules, and can adversely affect long-term reliability.

In a conventional Tin/Lead (Sn/Pb) solder process, peak reflow temperatures are limited to less than 235°C. Typically, the eutectic solder melts at 183°C, wets the land, and subsequently wicks the device connection. Sufficient time must be allowed to fuse the plating on the connection ensure a reliable solder joint. There are several types of SMT reflow technologies currently used in the industry. These surface mount power modules can be reliably soldered using natural forced convection, IR (radiant infrared), or a combination of convection/IR. For reliable soldering the solder reflow profile should be established by accurately measuring the modules block pin temperatures.

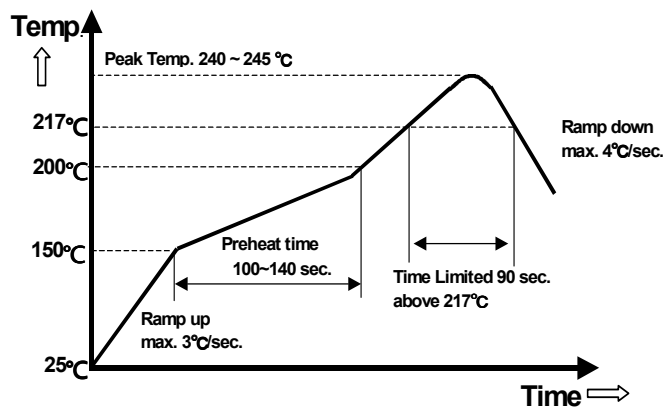

Figure 62: Recommended reflow profile using SAC305 solder paste

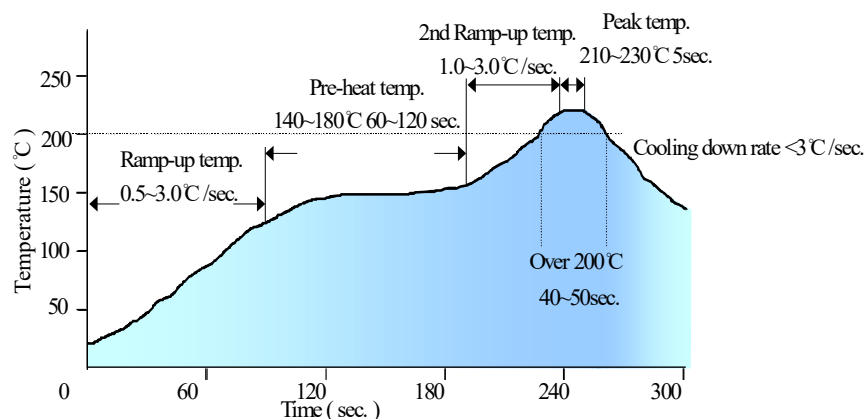

Figure 63: Recommended reflow profile

- Note: 1. The stencil thickness for soldering module to load board is recommended as 5mil.
2. Recommended soldering Nitrogen process.

APPLICATION NOTES

Module Dimensions after Mounting

The following data shows the analysis height-tolerance that is expected for the LGA1100D-01DADJJB module after it has been mounted to the host application PCB.

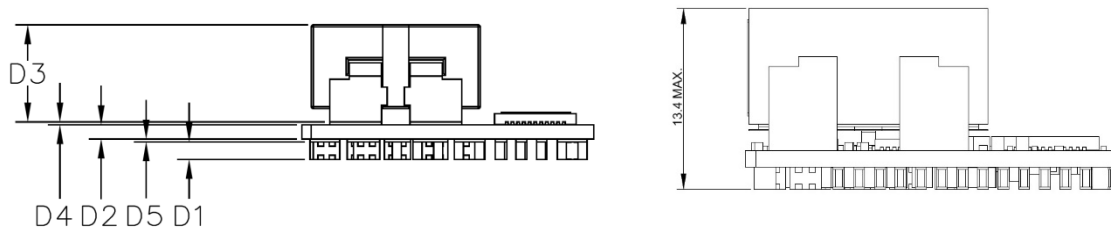

Ref	Description	Design Data Feature Type	Feature Dimension	
D1	Block PIN thickness	Machined	1.60	+0.04 -0.04
D2	PCB thickness	Other	1.2	+0.12 -0.12
D3	Inductor per max.height	Catalogue Size	10.30	+0.00 -0.00
D4	Max solder paste thk (inductor)	Other	0.0243	+0.0193 -0.0193
D5	Max solder paste thk (Block pin)	Other	0.03	+0.00 -0.00

Arithmetic Worst Case (AWC) Analysis

Use for safety critical dimensions

Arithmetic Worst Case Analysis assumes all tolerances are at their worst extreme and that all out of specification parts have been removed through inspection.

Note: the nominal dimension is in the positive sense

Nominal Dimension		Expected Value		Limit Values	Spec Parts All pass
13.1543	+0.1793	13.1543	+0.1793	13.3336 12.975	Yes
	-0.1793		-0.1793		

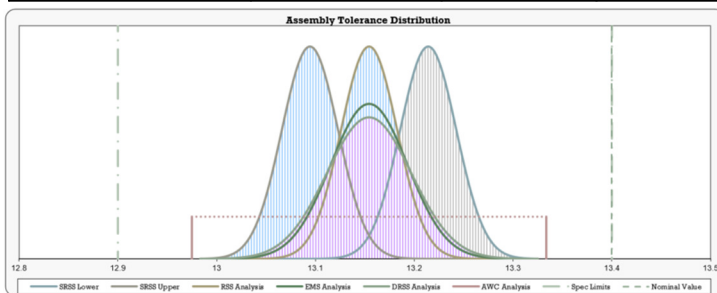

Height: Nominal = 13.154 + 0.06 (solder thk on system board)= 13.214mm Maximum = 13.334 + 0.06 (solder thk on system board)= 13.394mm Minimum = 12.975 + 0.06 (solder thk on system board)= 13.035mm

RECORD OF REVISION AND CHANGES

Issue	Date	Description	Originators
1.0	23.07.2023	First release	Derek Chan



For international contact information,
visit advancedenergy.com.

powersales@aei.com (Sales Support)
productsupport.ep@aei.com (Technical Support)
+1 888 412 7832



ABOUT ADVANCED ENERGY

Advanced Energy (AE) has devoted more than three decades to perfecting power for its global customers. AE designs and manufactures highly engineered, precision power conversion, measurement and control solutions for mission-critical applications and processes.

Our products enable customer innovation in complex applications for a wide range of industries including semiconductor equipment, industrial, manufacturing, telecommunications, data center computing, and medical. With deep applications know-how and responsive service and support across the globe, we build collaborative partnerships to meet rapid technological developments, propel growth for our customers, and innovate the future of power.

PRECISION | POWER | PERFORMANCE | TRUST

Specifications are subject to change without notice. Not responsible for errors or omissions. ©2023 Advanced Energy Industries, Inc. All rights reserved. Advanced Energy®, and AE® are U.S. trademarks of Advanced Energy Industries, Inc.