

AVD50B-48S05

50 Watts Sixteenth-brick Converter

Total Power: 50 Watts
Input Voltage: 36 to 75 Vdc
of Outputs: Single

Special Features

- Delivers up to 10A output current
- Ultra-high efficiency 91.5% typical at 10A load
- Wide input range: 36V ~ 75V
- Excellent thermal performance
- No minimum load requirement
- RoHS Directive(EU) 2015/863 (RoHS 3.0)
- Basic isolation
- High power density
- Low output noise
- Startup Pre-bias
- Remote control function
- Remote output sense
- Input under voltage lockout
- Output over current protection
- Output short circuit protection
- Output over voltage protection
- Over temperature protection
- Industry standard sixteenth-brick pin-out outline

Safety

IEC/EN/UL/CSA 62368-1
CE Mark
UL/TUV
Materials meet UL94, V-0
flammability rating
EN55023 ClassA with external
filter

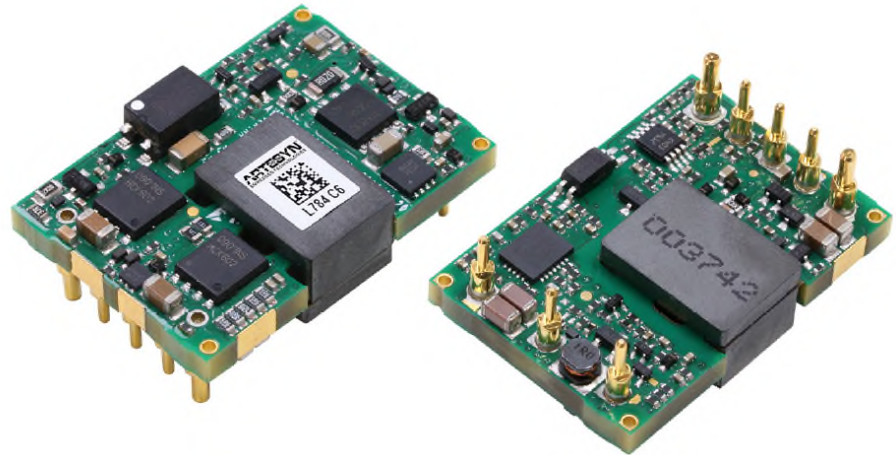

Product Descriptions

The AVD50B-48S05 is a single output DC/DC converter with standard sixteenth-brick outline and pin configuration. It delivers up to 10A output current with 5V output. Above 91.5% ultra-high efficiency and excellent thermal performance makes it an ideal choice to supply power in telecom and datacom.

Applications

Telecom / Datacom

Model Numbers

Standard	Output Power	Structure	Remote ON/OFF logic	Pin Length
AVD50B-48S05B-6L	50W	Baseplate	Negative	3.8mm
AVD50B-48S05-6L	50W	Open Frame	Negative	3.8mm
AVD50B-48S05TL	50W	Open Frame	Negative	SMT pin

Ordering information

AVD50B	-	48	S	05	P	B	-	6	L
①		②	③	④	⑤	⑥	⑦	⑧	⑨

①	Model series	AVD: high efficiency sixteenth brick series, 50: output power 50W
②	Input voltage	48: 36V ~ 75V input range, rated input voltage 48V
③	Output number	S: single output
④	Rated output voltage	05: 5V output
⑤	Remote ON/OFF logic	Default: negative logic; P: positive logic
⑥	Baseplate	B: with baseplate; default: open frame
⑦	-	Need "-" for through-hole unit, to separate the data of voltage and pin length, omit for SMT unit
⑧	Pin length	T: SMT; 6: 3.8mm ± 0.25mm
⑨	RoHS status	L:RoHS 3.0

Options

None

Electrical Specifications

Absolute Maximum Ratings

Stress in excess of those listed in the “Absolute Maximum Ratings” may cause permanent damage to the power supply. These are stress ratings only and functional operation of the unit is not implied at these or any other conditions above those given in the operational sections of this TRN. Exposure to any absolute maximum rated condition for extended periods may adversely affect the power supply’s reliability.

Table 1. Absolute Maximum Ratings:

Parameter	Model	Symbol	Min	Typ	Max	Unit
Input Voltage Operating -Continuous Non-operating -100mS	All	$V_{IN,DC}$	-	-	80	Vdc
	All		-	-	100	Vdc
Maximum Output Power	All	$P_{O,max}$	-	-	50	W
Isolation Voltage ¹² Input to output	All		-	-	1500	Vdc
Ambient Operating Temperature	All	T_A	-40	-	+85	°C
Storage Temperature	All	T_{STG}	-55	-	+125	°C
Voltage at remote ON/OFF pin	All		-0.3	-	12	Vdc

Note 1 - 1mA for 60s, slew rate of 1500V/10s

Note 2 - Basic insulation, pollution degree 2

Input Specifications

Table 2. Input Specifications:

Parameter	Conditions ¹	Symbol	Min	Typ	Max	Unit
Operating Input Voltage, DC	All	$V_{IN,DC}$	36	48	75	Vdc
Turn-on Voltage Threshold	$I_O = I_{O,max}$	$V_{IN,ON}$	31	-	36	Vdc
Turn-off Voltage Threshold	$I_O = I_{O,max}$	$V_{IN,OFF}$	30	-	35	Vdc
Lockout Voltage Hysteresis	$I_O = I_{O,max}$		1	-	3	V
Maximum Input Current	$V_{IN,DC} = 36V_{DC}$ $I_O = I_{O,max}$	$I_{IN,max}$	-	-	2	A
Recommended Input Fuse	Fast blow external fuse recommended		-	-	5	A
Recommended External Input Capacitance	Low ESR capacitor recommended	C_{IN}	100	220	-	uF
Input Reflected Ripple Current	Through 12uH inductor		-	18	-	mA
Operating Efficiency	$I_O = I_{O,max}$	η	-	91.5	-	%
	$I_O = 50\% I_{O,max}$		-	88.5	-	%

Note 1 - $T_a = 25\text{ }^\circ\text{C}$, airflow rate = 400 LFM, $V_{in} = 48\text{Vdc}$, nominal V_{out} unless otherwise noted.

Output Specifications

Table 3. Output Specifications:

Parameter	Condition ¹	Symbol	Min	Typ	Max	Unit	
Factory Set Voltage	$V_{IN,DC} = 48Vdc$ $I_O = 50\% I_{O,max}$	V_O	4.95	5.0	5.05	Vdc	
Output Voltage Line Regulation	All	$\pm\%V_O$ $\pm V_O$	- -	- -	0.15 7.5	% mV	
Output Voltage Load Regulation	All	$\pm\%V_O$ $\pm V_O$	- -	- -	0.15 7.5	% mV	
Output Voltage Temperature Regulation	All	$\%V_O$	-	-	0.02	%/°C	
Total output voltage range (Over sample, line, load, temperature & life)	All	V_O	4.9	5.0	5.1	V	
Output Voltage Trim Range	All	V_O	4	-	5.5	V	
Output Ripple, pk-pk ²	20MHz bandwidth	V_O	-	35	-	mV _{PK-PK}	
Output Current	All	I_O	0	-	10	A	
Output DC current-limit inception ³		I_O	11	-	18	A	
V_O Load Capacitance ⁴	All	C_O	220	-	10000	uF	
V_O Dynamic Response	Peak Deviation	25%~50%~25% or 50%~75%~50% 25% load change slew rate = 0.1A/us	$\pm V_O$	-	85	-	mV
	Settling Time	25%~50%~25% or 50%~75%~50% 25% load change slew rate = 1A/us	T_s	-	50	-	uSec
Turn-on transient	Rise time		T_{rise}	-	20	-	mS
	Turn-on delay time		$T_{turn-on}$	-	10	-	mS
	Output voltage overshoot		$\%V_O$	-	-	5	%

Note 1 - $T_a = 25^\circ C$, airflow rate = 400 LFM, $V_{in} = 48Vdc$, nominal V_{out} unless otherwise noted.

Note 2 - Test condition: 10u tantalum (ESR≤100 mΩ)// 1u ceramic capacitor; Figure 16.

Note 3 - Hiccup.

Note 4 - High frequency and low ESR is recommended.

Output Specifications

Table 3. Output Specifications, con't:

Parameter	Condition ¹	Symbol	Min	Typ	Max	Unit
Switching frequency	All	f_{sw}	-	350	-	KHz
Remote ON/OFF control (positive logic)	Off-state voltage		-0.3	-	1.2	V
	On-state voltage		3.5	-	12	V
Remote ON/OFF control (Negative logic)	Off-state voltage		3.5	-	12	V
	On-state voltage		-0.3	-	1.2	V
Output over-voltage protection ⁵	Static Dynamic	V_o	5.8 5.8	- -	6.7 7.0	V
Output over-temperature protection ⁶	All	T	-	120	-	°C
Over-temperature hysteresis	All	T	-	10	-	°C
Output voltage remote sense range	All	$\%V_o$	-	-	± 5	%
MTBF	Telcordia SR-332 Method 1 Case3, 80% load, 300LFM, 40 °C T_A		-	2	-	10 ⁶ h

Note 5 - Hiccup: auto-restart when over-voltage condition is removed.

Note 6 - Auto recovery. See Figure 9, Figure 10 for the over-temperature protection (OTP) test point.

AVD50B-48S05 Performance Curves

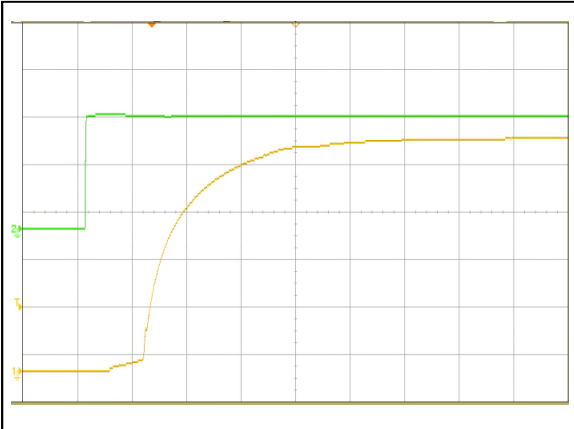

Figure 1: AVD50B-48S05 Output Voltage Startup Characteristic (10mS/div)
 Ch 1: Vo (1V/div) Ch 2: Vin (20V/div)

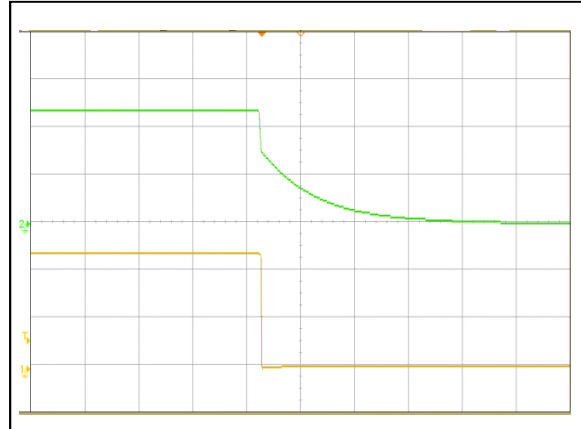

Figure 2: AVD50B-48S05 Turn Off Characteristic (20mS/div)
 Ch 1: Vo (2V/div) Ch 2: Vin (20V/div)

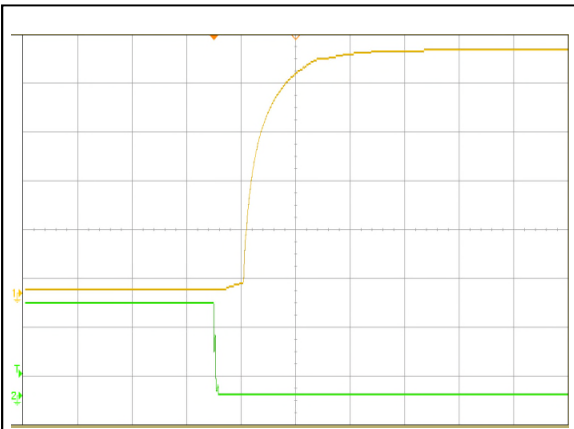

Figure 3: AVD50B-48S05 Remote ON Waveform (20mS/div)
 Ch 1: Vo (1V/div) Ch 2: Remote ON (2V/div)

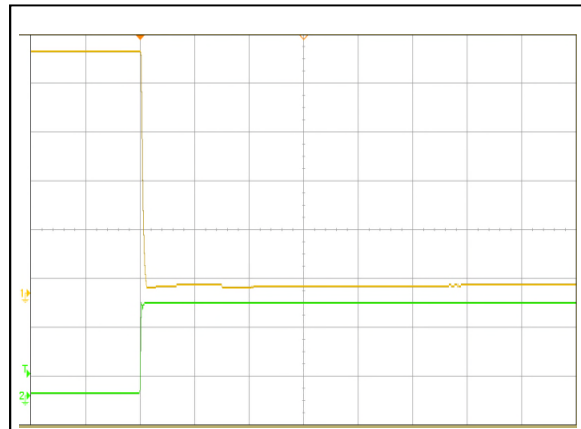

Figure 4: AVD50B-48S05 Remote OFF Waveform (10mS/div)
 Ch 1: Vo (1V/div) Ch 2: Remote ON (2V/div)

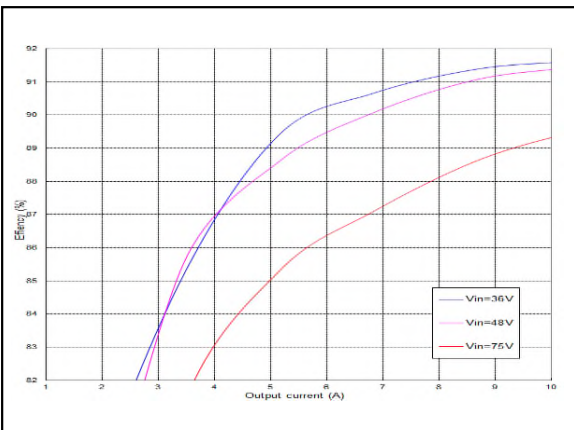

Figure 5: AVD50B-48S05 Efficiency Curves @ 25 °C, 400LFM
 Loading: Io = 10% increment to 10A

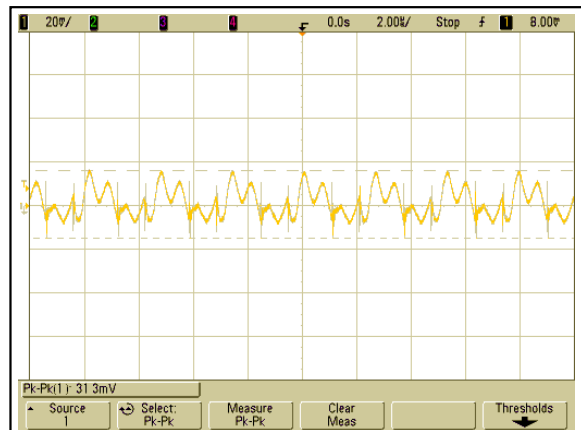

Figure 6: AVD50B-48S05 Ripple and Noise Measurement
 Ch 1: Vo (2uS/div, 20mV/div)

AVD50B-48S05 Performance Curves

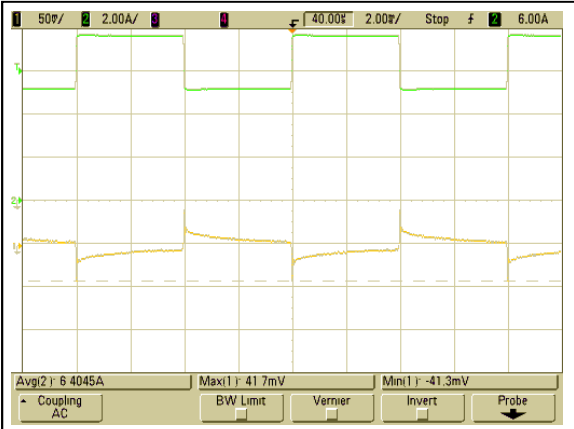

Figure 7: AVD50B-48S05 Transient Response (2mS/div) 0.1A/uS slew rate
 Ch 1: Vo (50mV/div) Ch 2: Io (2A/div)

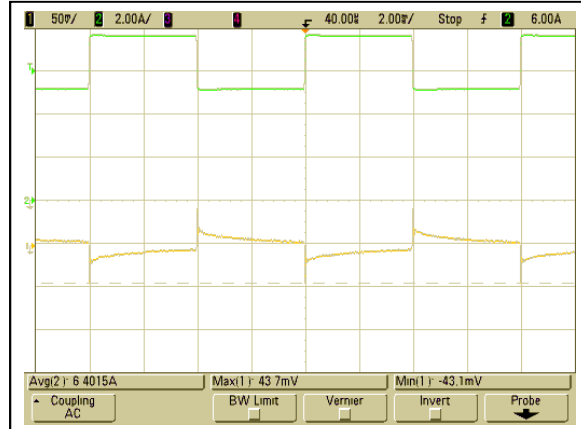

Figure 8: AVD50B-48S05 Transient Response (2mS/div) 1A/uS slew rate
 Ch 1: Vo (50mV/div) Ch 2: Io (2A/div)

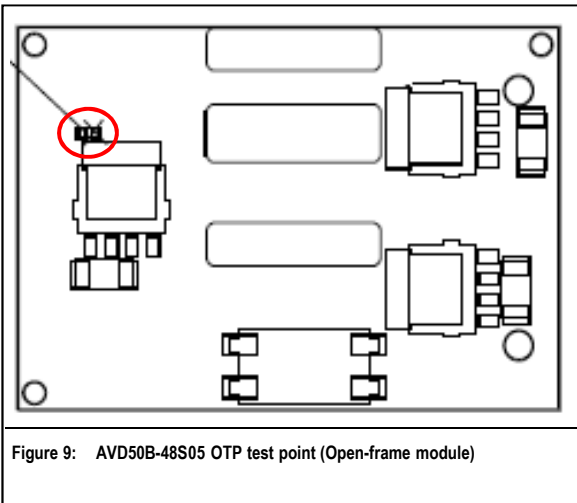

Figure 9: AVD50B-48S05 OTP test point (Open-frame module)

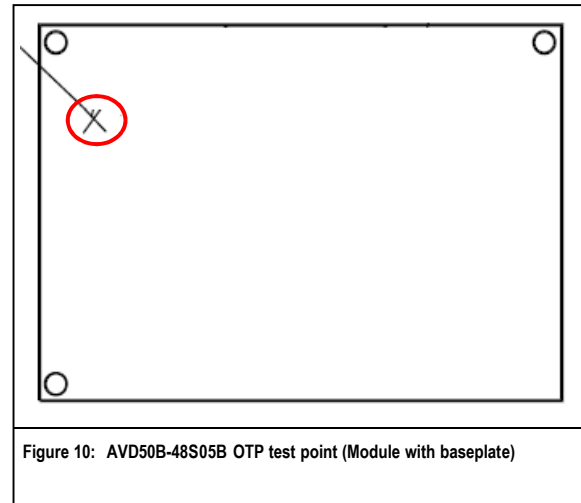
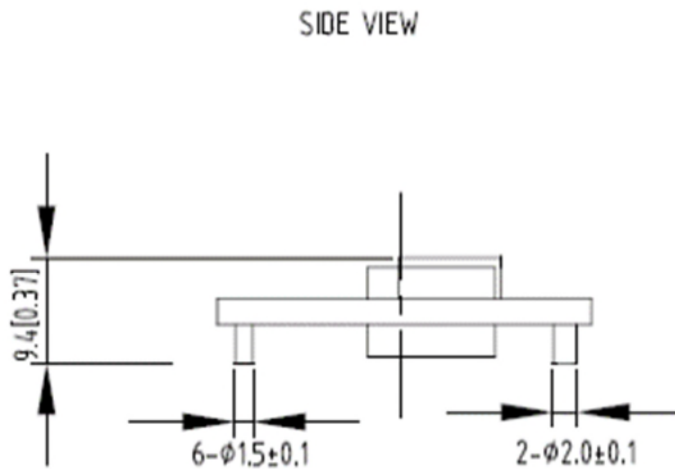
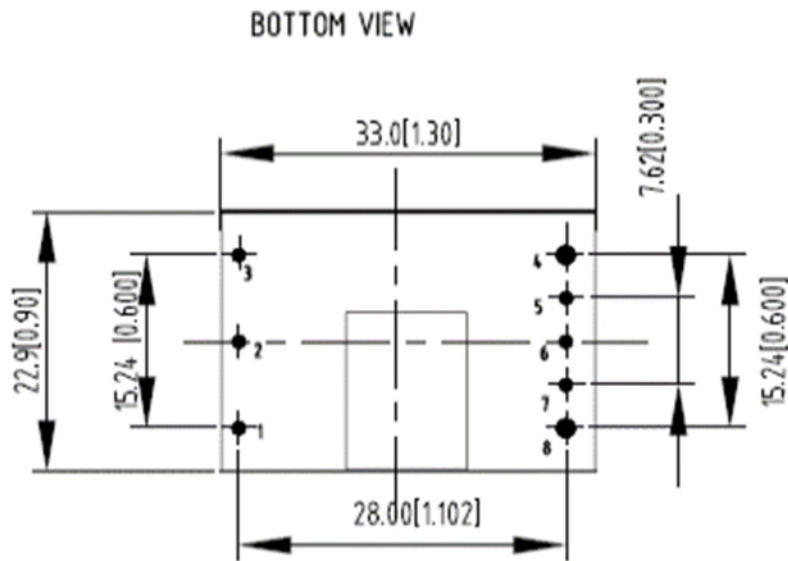

Figure 10: AVD50B-48S05B OTP test point (Module with baseplate)

Mechanical Specifications

Mechanical Outlines

Surface mounted module mechanical diagram



UNIT: mm[inch]

TOLERANCE: X.Xmm±0.5mm[X.XX in.±0.02in.]

X.XXmm±0.25mm[X.XXX in.±0.01in.]

Open frame module mechanical diagram

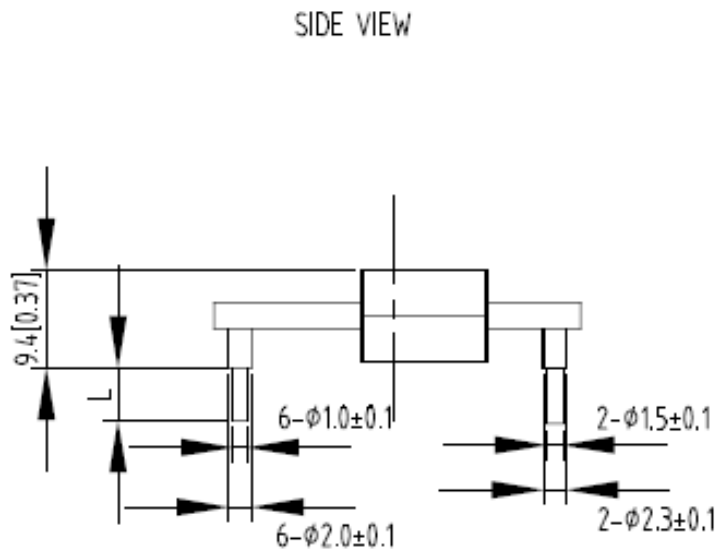
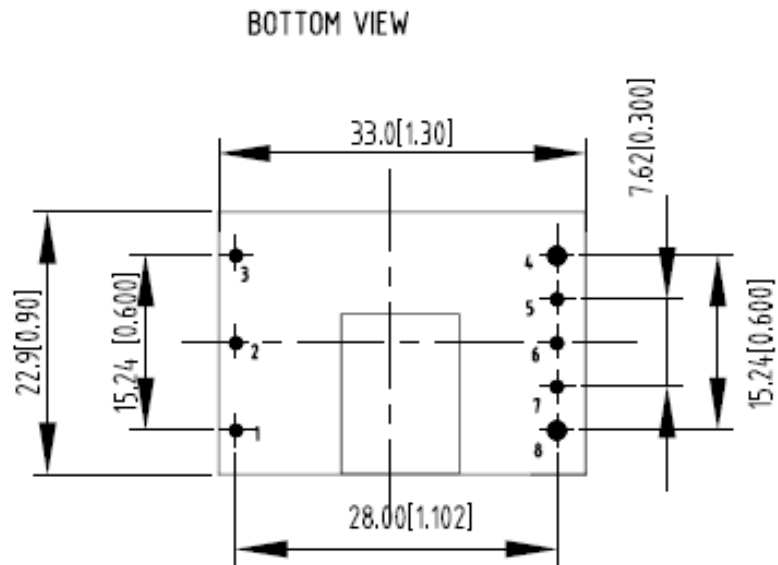

UNIT: mm[inch]

TOLERANCE: X.Xmm±0.5mm[X.XX in.±0.02in.]

X.XXmm±0.25mm[X.XXX in.±0.01in.]

Module mechanical diagram with baseplate

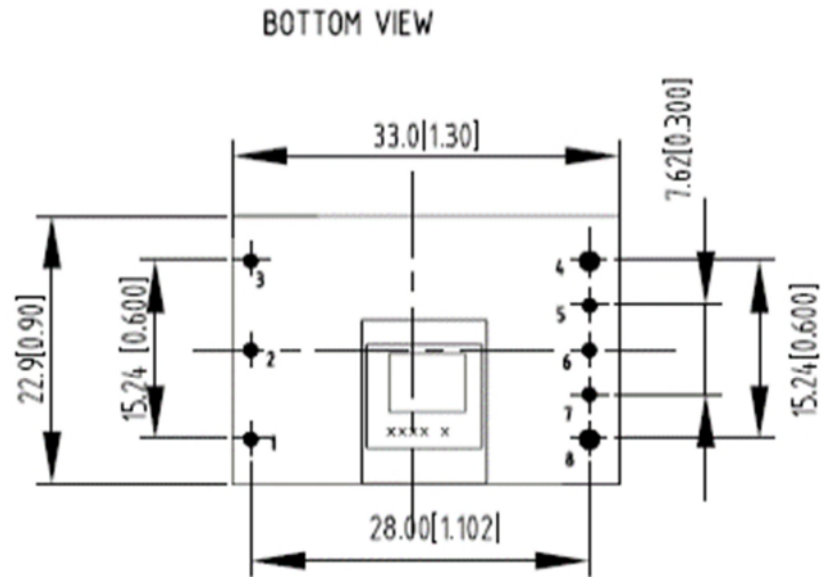

SIDE VIEW

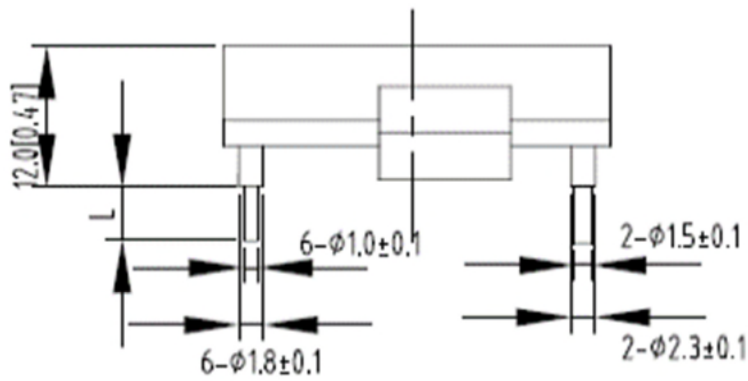

UNIT: mm[inch]

TOLERANCE: X.Xmm±0.5mm[X.XX in.±0.02in.]

X.XXmm±0.25mm[X.XXX in.±0.01in.]

Pin Length Option

Device code suffix	L
-4	4.8mm ±0.25 mm
-6	3.8mm ±0.25 mm
-8	2.8mm ±0.25 mm
None	5.8mm ±0.25 mm

Pin Designations

Pin No	Name	Function
1	Vin+	Positive input voltage
2	Remote ON/OFF	Remote ON/OFF control
3	Vin-	Negative input voltage
4	Vo-	Negative output voltage
5	S-	Negative remote sense
6	Trim	Output voltage trim
7	S+	Positive remote sense
8	Vo+	Positive output voltage

Environmental Specifications

EMC Immunity

AVD50B-48S05 power supply is designed to meet the following EMC immunity specifications:

Table 4. Environmental Specifications:

Document	Description	Criteria
EN55023, DC input port, Class A	Conducted and Radiated EMI Limits	/
IEC/EN 61000-4-2, Enclosure port, Level 3	Electromagnetic Compatibility (EMC) - Testing and measurement techniques: Electrostatic discharge immunity test	B
IEC/EN 61000-4-4, Level 3	Electromagnetic Compatibility (EMC) - Testing and measurement techniques: Electrical Fast Transient. DC input port	B
IEC/EN 61000-4-5	Electromagnetic Compatibility (EMC) - Testing and measurement techniques: Immunity to surges - 600V common mode and 600V differential mode for DC input port	B
IEC/EN 61000-4-6, Level 2	Electromagnetic Compatibility (EMC) - Testing and measurement techniques: Continuous Conducted Interference. DC input port	A
EN61000-4-29	Electromagnetic Compatibility (EMC) - Testing and measurement techniques: Voltage Dips and short interruptions and voltage variations. DC input port	B

Criterion A: Normal performance during and after test.

Criterion B: For EFT and surges, low-voltage protection or reset is not allowed. Temporary output voltage fluctuation ceases after disturbances ceases, and from which the EUT recovers its normal performance automatically. For Dips and ESD, output voltage fluctuation or reset is allowed during the test, but recovers to its normal performance automatically after the disturbance ceases.

Criterion C: Temporary loss of output, the correction of which requires operator intervention.

Criterion D: Loss of output which is not recoverable, owing to damage to hardware.

Safety Certifications

The AVD50B-48S05 power supply is intended for inclusion in other equipment and the installer must ensure that it is in compliance with all the requirements of the end application. This product is only for inclusion by professional installers within other equipment and must not be operated as a stand alone product.

Table 5. Safety Certifications for AVD50B-48S05 series power supply system

Document	File #	Description
UL 62368-1		US Requirements
EN 62368-1		European Requirements
IEC 62368-1		International Requirements
CE		CE Marking
UL94		US Requirements

Operating Temperature

The AVD50B-48S05 series power supplies will start and operate within stated specifications at an ambient temperature from -40 °C to 85 °C under all load conditions. The storage temperature is -55 °C to 125 °C.

Thermal Considerations

The converter is designed to operate in different thermal environments and sufficient cooling must be provided. Proper cooling can be verified by measuring the temperature at the test points as shown in the Figure 11. The temperature at these points should not exceed the max values in Table 6.

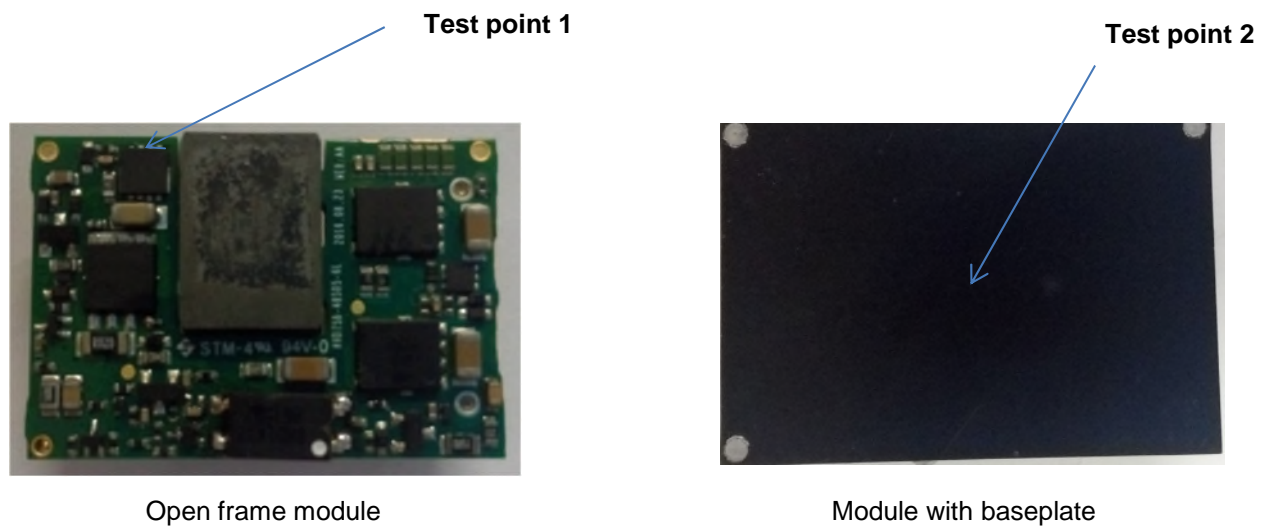
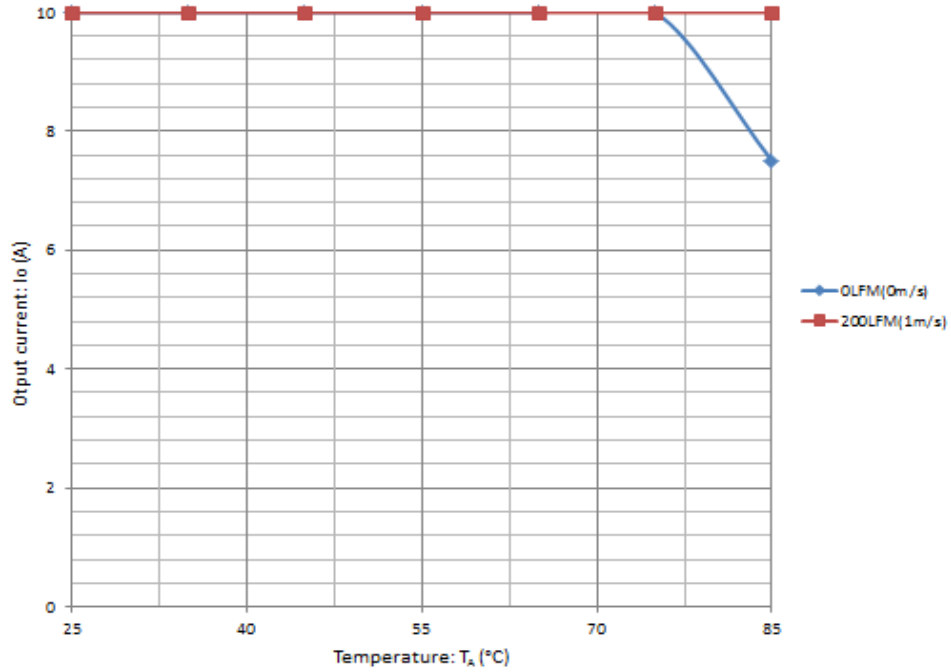

Figure 11 Temperature test point

Table 6. Temperature limit of the test points

Test Point	Temperature Limit
Test point 1	115 °C
Test point 2	120 °C

For a typical application, Figure 12 shows the derating of output current vs. ambient air temperature at different air velocity.



AVD50B-48S05-6L and AVD50B-48S05TL

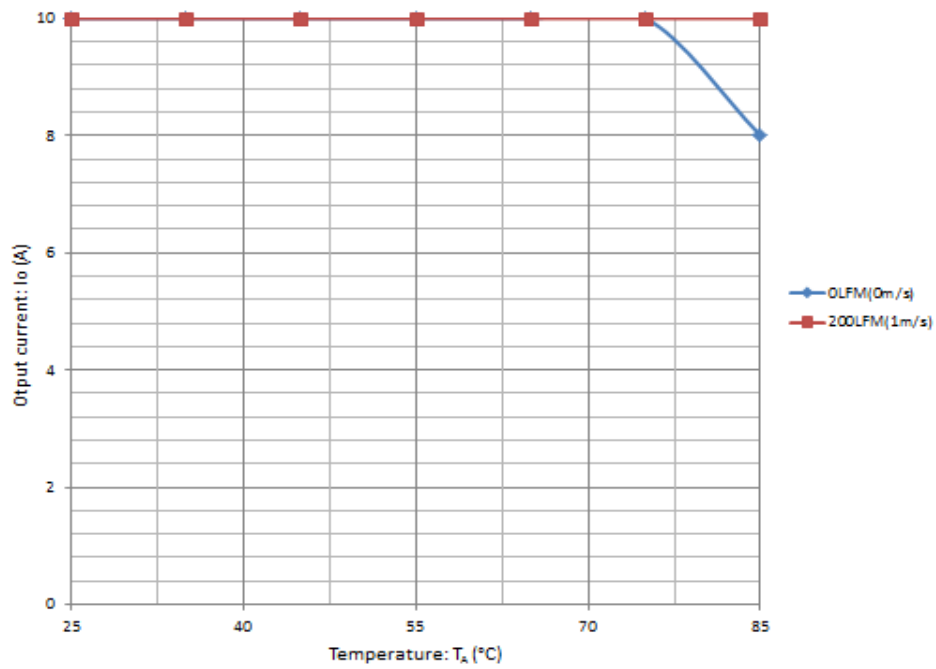

AVD50B-48S05B-6L

Figure 12 Output power derating, 48V_{in}, air flowing across the converter (from Vin- to Vin+)

Qualification Testing

Parameter	Unit (pcs)	Test condition
Halt test	4-5	$T_{a,min} - 20\text{ }^{\circ}\text{C}$ to $T_{a,max} + 25\text{ }^{\circ}\text{C}$, $10\text{ }^{\circ}\text{C}$ step, $V_{in} = \text{min to max}$, $0 \sim 100\%$ load
Vibration	3	Frequency range: $5\text{Hz} \sim 20\text{Hz}$, $20\text{Hz} \sim 200\text{Hz}$, A.S.D: $1.0\text{m}^2/\text{s}^3$, -3db/oct , axes of vibration: X/Y/Z. Time: 30min/axes
Mechanical Shock	3	30g , 6ms , 3axes , 6directions , 3time/direction
Thermal Shock	3	$-55\text{ }^{\circ}\text{C}$ to $125\text{ }^{\circ}\text{C}$, unit temperature 20cycles
Thermal Cycling	3	$-40\text{ }^{\circ}\text{C}$ to $85\text{ }^{\circ}\text{C}$, temperature change rate: $1\text{ }^{\circ}\text{C/min}$, cycles: 2cycles
Humidity	3	$40\text{ }^{\circ}\text{C}$, $95\%\text{RH}$, 48h
Solder Ability	15	IPC J-STD-002C-2007

Application Notes

Typical Application

Below is the typical application of the AVD50B-48S05 series power supply.

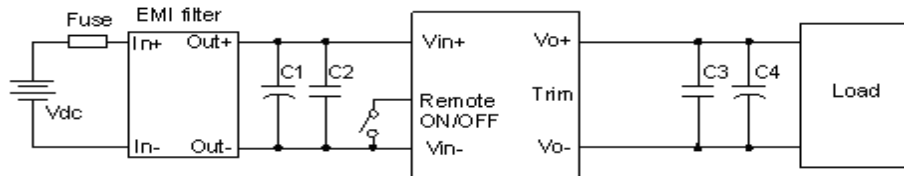

Figure 13 Typical application

C1: 100 μ F/100V electrolytic capacitor; P/N: UPM2A101MPD (Nichicon) or equivalent caps.

C2,C3: 1 μ F/100V X7R ceramic capacitor, P/N: C3216X7R2A105KT0L0S (TDK) or equivalent caps.

C4:220 μ F oscon capacitor, P/N: CUXAE1C221M2BA(Sanyo).

Fuse: External fast blow fuse with a rating of 5A. The recommended fuse model is 0453005.MR from LITTLEFUSE.

Note: EMI filter: see Figure 18.

Remote ON/OFF

Negative remote ON/OFF logic is available in AVD50B-48S05. The logic is CMOS and TTL compatible.

The voltage between pin Remote ON/OFF and pin Vin- must not exceed the range listed in Table 3 to ensure proper operation. The external Remote ON/OFF circuit is highly recommended as shown in Figure 14.

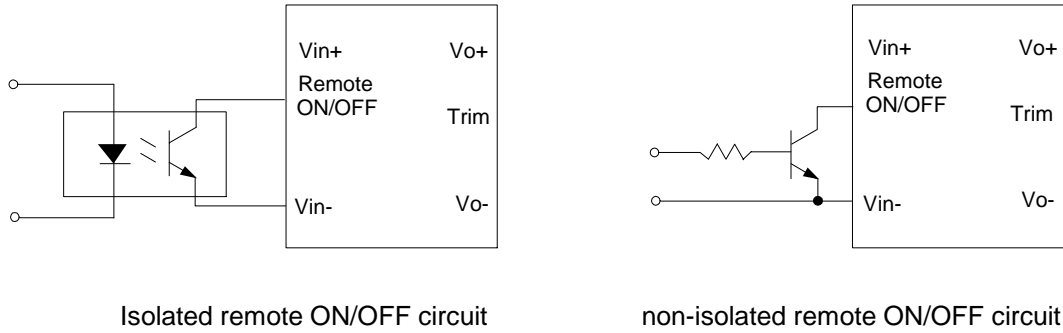

Figure 14 External Remote ON/OFF circuit

Trim Characteristics

Connecting an external resistor between Trim pin and Vo- pin will decrease the output voltage, while connecting it between Trim and Vo+ will increase the output voltage. The following equations determine the external resistance to obtain the trimmed output voltage.

$$R_{adj-down} = \frac{510}{\Delta} - 10.2(K\Omega)$$

$$R_{adj-up} = \frac{5.1 \times V_{o,nom} \times (100 + \Delta)}{1.225 \times \Delta} - \frac{510}{\Delta} - 10.2(K\Omega)$$

Δ : Output rate against nominal output voltage.

$$\Delta = \frac{100 \times (V_o - V_{o,nom})}{V_{o,nom}}$$

V_{norm} : Nominal output voltage.

For example, to get 5.5V output, the trimming resistor is

$$\Delta = \frac{100 \times (V_o - V_{o,nom})}{V_{o,nom}} = \frac{100 \times (5.5 - 5)}{5} = 10$$

$$R_{adj-up} = \frac{5.1 \times 5 \times (100 + 10)}{1.225 \times 10} - \frac{510}{10} - 10.2 = 167.78(K\Omega)$$

When trimming up, the output current should be decreased accordingly so as not to exceed the maximum output power.

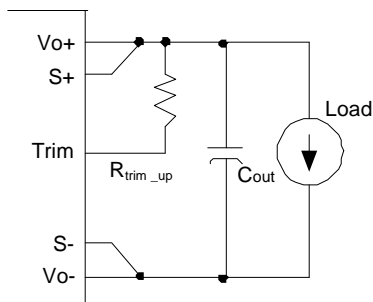

Figure 15 Trim up

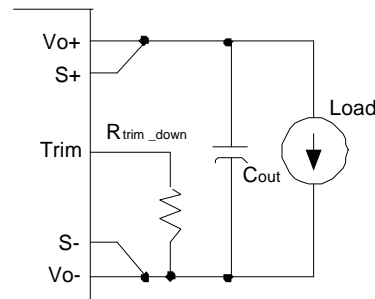

Figure 16 Trim down

If the sense compensate function is not necessary, connect S+ to Vo+ and S- to Vo- directly.

Input Ripple & Inrush Current And Output Ripple & Noise Test Configuration

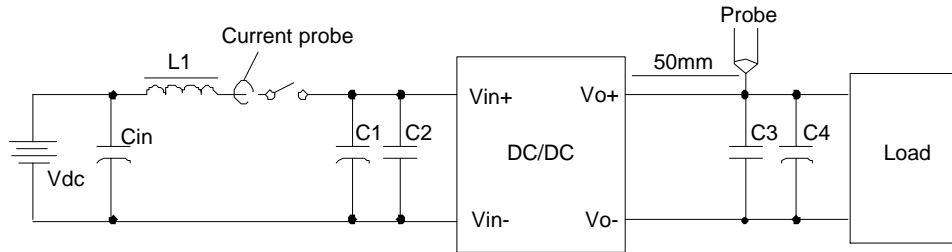

Figure 17 Input ripple & inrush current, output ripple & noise test configuration

Vdc: DC power supply

L1: 12 μ H

Cin: 220 μ F/100V typical

C1 ~ C4: See Figure 13

Note: Using a coaxial cable with series 50 Ω resistor and 0.68 μ F ceramic capacitor or a ground ring of probe to test output ripple & noise is recommended.

EMC Test Conditions

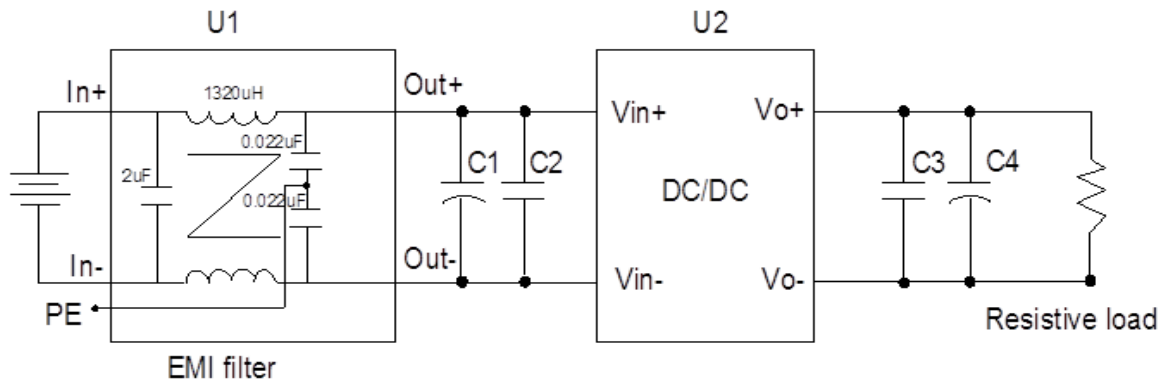

Figure 18 EMC test conditions

U1: Input EMC filter

U2: Module to test, AVD50B-48S05

C1 ~ C4: See Figure 13

Soldering

The product is intended for standard manual or wave soldering.

	Product Requirement	Product Name
R6	Wave soldering	AVD50B-48S05B-6L AVD50B-48S05-6L

When wave soldering is used, the temperature on pins is specified to maximum 260 °C for maximum 7s.

When soldering by hand, the iron temperature should be maintained at 300 °C ~ 380 °C and applied to the converter pins for less than 10s. Longer exposure can cause internal damage to the converter. Cleaning of solder joint can be performed with cleaning solvent IPA or simulative.

The below products are intended for standard reflow soldering.

	Product Requirement	Product Name
R6	Reflow soldering	AVD50B-48S05-6L AVD50B-48S05TL

When reflow soldering is used, Please refer to following fig for recommended temperature profile parameters.

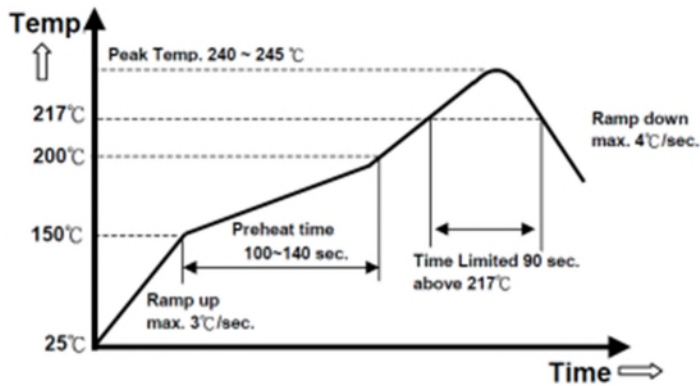

Record of Revision and Changes

Issue	Date	Description	Originators
1.0	08.04.2017	First Issue	E.Wang
1.1	12.18.2019	Update soldering information	E.Wang
1.2	02.24.2020	Update RoHS status	C.Liu
1.3	05.28.2020	Update safety cert. from 60950 to 62368-1	E.Wang

WORLDWIDE OFFICES

Americas

2900 South Diablo Way
 Suite B100
 Tempe, AZ 85282
 USA
 +1 888 412 7832

Europe (UK)

Ground Floor Offices
 Barberrry House, 4 Harbour Buildings
 Waterfront West, Brierley Hill
 West Midlands, DY5 1LN, UK
 +44 (0) 1384 842 211

Asia (HK)

14/F, Lu Plaza
 2 Wing Yip Street
 Kwun Tong, Kowloon
 Hong Kong
 +852 2176 3333



For more information: www.artesyn.com
 For support: productsupport.ep@artesyn.com