

ARTESYN LCM3000 SERIES

3000 Watts Bulk Front End



PRODUCT DESCRIPTION

Advanced Energy's Artesyn LCM3000 series provide for a very wide range of AC-DC embedded power requirement. Featuring high build quality with robust screw terminals, long life, and typical full-load efficiency of greater than 90 percent, these units are ideal for use in industrial and medical applications. They are backed by a comprehensive set of industrial and medical safety approvals and certificates. Variable-speed 'Smart Fans' draw on software controls developed by Advanced Energy to match fan speed to the unit's cooling requirement and load current. Slowing the fan not only saves power but also reduces wear, thus extending its life.

SPECIAL FEATURES

- 3000 watts output power
- Low cost
- 2.5" x 7.0" x 10.9"
- 15.7 watts per cubic inch
- Industrial/medical safety
- -40 °C to 70 °C with derating
- 5 Vdc @ 2 A Housekeeping
- High efficiency: 90% typical
- Variable speed "smart fans"
- DSP controlled
- Conformal coat option
- ±25% adjustment range
 - Up to +33% on LCM30007-T
- V-Programming from 20% to 125%
 - Up to 133% on LCM30007-T
- VAR configurable to any voltage from a single unit
- Semi F47 compliance at high line
- Five-year warranty

COMPLIANCE

- EMI Class A, with 6db margin
- EN61000 Immunity
- RoHS3

SAFETY

- UL/cUL Recognized
- ITE(UL/CSA62368-1)
- ANSI/AAMI ES60601-1L
- TUV-SuD ITE + Medical
- CE LVD (EN62368-1 + ROHS)
- UKCA Mark
- CB Report
 - through Demko for IEC60950-1
 - through TUV-SuD for IEC60601-1
 - through DEMKO for IEC62368-1

AT A GLANCE

Total Power

3000 Watts

Input Voltage

90 to 264 Vac

128 to 370 Vdc

of Outputs

Single



MODEL NUMBERS

Model	Output Voltage	Minimum Load	Maximum Load	Trim Range ($\pm 25\%$)	Vprog Adjustment Range (20% to 125%Vo) ¹	Adjustment Range	
						Maximum Load	Max Power (3000W)
LCM3000L-T	12Vdc	0A	250A	9 - 15Vdc	2.4 - 15Vdc	2.4 - 12Vdc	12 - 15Vdc
LCM30008-T	18Vdc	0A	166.7A	13.5 - 22.5Vdc	3.6 - 22.5Vdc	3.6 - 18Vdc	18 - 22.5Vdc
LCM3000Q-T	24Vdc	0A	125A	18 - 30Vdc	4.8 - 30Vdc	4.8 - 24Vdc	24 - 30Vdc
LCM3000U-T	36Vdc	0A	83.3A	27 - 45Vdc	7.2 - 45Vdc	7.2 - 36Vdc	36 - 45Vdc
LCM3000W-T	48Vdc	0A	62.5A	36 - 60Vdc	9.6 - 60Vdc	9.6 - 48Vdc	48 - 60Vdc
LCM30007-T	72Vdc	0A	41.7A	54 - 96Vdc	14.4V - 96Vdc	14.4 - 72Vdc	72 - 96Vdc

Note 1 - Vprog adjustment range for LCM30007-T is 20% to 133% and trim range is -25% to 33%.

Options

Blank = No Options

1 = Conformal Coat

2 = Reverse Air

3 = Opt 1 + 2

A = Reverse Logic for Inhibit / Enable

ELECTRICAL SPECIFICATIONS

Absolute Maximum Ratings

Stress in excess of those listed in the “Absolute Maximum Ratings” may cause permanent damage to the power supply. These are stress ratings only and functional operation of the unit is not implied at these or any other conditions above those given in the operational sections of this TRN. Exposure to any absolute maximum rated condition for extended periods may adversely affect the power supply’s reliability.

Table 1. Absolute Maximum Ratings						
Parameter	Model	Symbol	Min	Typ	Max	Unit
Input Voltage AC continuous operation DC continuous operation	All models	$V_{IN,AC}$ $V_{IN,DC}$	90 128	- -	264 370	Vac Vdc
Maximum Output Power $V_{IN,AC} \leq 180V_{AC}$ $V_{IN,AC} > 180V_{AC}$	All models	$P_{O,max}$	- -	- -	1500 3000	W W
Isolation Voltage (Qualification) Input to outputs (2X MOPP) Input to safety ground Outputs to safety ground	All models		- - -	- - -	4000 ² 2000 500	Vac Vac Vdc
Isolation Voltage (Production) Input to outputs Input to safety ground	All models		- -	- -	2000 2200	Vdc Vdc
Ambient Operating Temperature	All models	T_A	-40	-	+70	°C
Storage Temperature	All models	T_{STG}	-40	-	+85	°C
Humidity (non-condensing) Operating Non-operating	All models		20 10	- -	90 95	% %
Altitude Operating Non-operating	All models		- -	- -	16405 30000	feet feet

Note 1 - Output power is derated 50% linearly from 50 °C to 70 °C.
 Note 2 - Must remove chassis and Y-cap during testing.

ELECTRICAL SPECIFICATIONS

Input Specifications

Table 2. Input Specifications						
Parameter	Condition	Symbol	Min	Typ	Max	Unit
Operating Input Voltage, AC	All	$V_{IN,AC}$	90	115/230	264	Vac
Operating Input Voltage, DC	All	$V_{IN,DC}$	128	-	370	Vdc
Input AC Frequency ¹	All	f_{IN}	47	50/60	63	Hz
Maximum Input Current ($I_O = I_{O,max}$, $I_{SB} = I_{SB,max}$)	$V_{IN,AC} = 90Vac$	$I_{IN,max}$	-	-	20	A
No Load Input Current ($V_O = On$, $I_O = 0A$, $I_{SB} = 0A$)	$V_{IN,AC} = 90Vac$ $V_{IN,AC} = 264Vac$	$I_{IN,no-load}$	-	3	30	A
Harmonic Line Currents	All	THD	IEC 61000-3-2			
Power Factor	$I_O = I_{O,max}$ $V_{IN,AC} = 90$ to $264Vac$	PF	0.95	-	-	-
Startup Surge Current (Inrush) @ 25°C	$V_{IN,AC} = 230Vac$	$I_{IN,surge}$	-	-	60	A _{PK}
Input Fuse	Internal, L and N 250Vac rated		-	30	-	A
Input AC Low Line Start-up Voltage	$I_O = I_{O,max}$	$V_{IN,AC-start}$	82	-	92	Vac
Input AC Undervoltage Lockout Voltage	$I_O = I_{O,max}$	$V_{IN,AC-stop}$	79	-	89	Vac
Ripple Switching Frequency	All	$f_{SW,DC-DC}$	120	-	140	kHZ
Efficiency ($T_A = 25^\circ C$, forced air cooling)	$V_{IN,AC} = 230Vac$ $I_O = I_{O,max}$	η	88	90	-	%
PFC Switching Frequency	All	$f_{SW,PFC}$	-	65	-	kHZ
Leakage Current to Safety Ground	$V_{IN} = 240Vac$ $f_{IN} = 60Hz$	$I_{IN,leakage}$	-	-	0.5	mA

Note 1 - Functional support 360 to 440Hz input frequency.

ELECTRICAL SPECIFICATIONS

Output Specifications

Table 3. Output Specifications							
Parameter		Condition	Symbol	Min	Typ	Max	Unit
Factory Set Voltage	LCM3000L-T	$I_O = 0A$	$V_{O, factory}$	11.94	12.00	12.06	Vdc
	LCM30008-T			17.91	18.00	18.09	
	LCM3000Q-T			23.88	24.00	24.12	
	LCM3000U-T			35.82	36.00	36.18	
	LCM3000W-T			47.76	48.00	48.24	
	LCM30007-T			71.64	72.00	72.36	
Output Adjustment Range	LCM3000L-T	$I_O = 0A$ See Note 1	V_O	2.4	-	15.0	Vdc
	LCM30008-T			3.6	-	22.5	
	LCM3000Q-T			4.8	-	30.0	
	LCM3000U-T			7.2	-	45.0	
	LCM3000W-T			9.6	-	60.0	
	LCM30007-T			14.4	-	96.0	
Total Regulation		Inclusive of set-point, line, load temperature change, warm-up drift	V_O	-	-	1	% V_O
			V_{SB}	-	-	5	% V_{SB}
Output Ripple, pk-pk	LCM3000L-T	See Note 2	V_O	-	-	150	mV
	LCM30008-T			-	-	180	
	LCM3000Q-T			-	-	240	
	LCM3000U-T			-	-	360	
	LCM3000W-T			-	-	480	
	LCM30007-T			-	-	720	
Hold Up Time		See Note 3	$t_{Hold-Up}$	14	-	-	mS
Output Current, continuously	LCM3000L-T	All	$I_{O,max}$	0	-	250	A
	LCM30008-T			0	-	166.7	
	LCM3000Q-T			0	-	125	
	LCM3000U-T			0	-	83.3	
	LCM3000W-T			0	-	62.5	
	LCM30007-T			0	-	41.7	
	All models		I_{SB}	0	-	2	
V_O Dynamic Response	Peak Deviation Settling Time	10% load change, slew rate = 1A/uS	$\pm\%V_O$	-	-	± 5	%
			t_s	-	-	300	uS
Turn On Overshoot		$I_O = 0A$	% V_O	-	-	5	%

Note 1 - See page 24 for Trimming Resistor.

Note 2 - Measure with a 0.1uF ceramic capacitor in parallel with a 10uF tantalum capacitor using a 20MHz bandwidth limited oscilloscope.

Note 3 - Adjusting the Output to higher tolerance (i.e. 28.8V which is the +20% adjustment range of 24V Nominal) will give a typical hold-up of 10mS.

ELECTRICAL SPECIFICATIONS

System Timing Specifications

Table 4. Specifications

Label	Parameter	Min	Typ	Max	Unit
T1	Delay from AC being applied to ACOK signal assertion (going Low).	200	-	1000	mS
T2	Delay from AC loss to ACOK signal de-assertion (going High).	-	-	50	mS
T3	Delay from AC being applied to main output being within regulation.	-	-	3000	mS
T4	Delay from AC loss to main output being within regulation. Main output set at nominal voltage setting.	14	-	-	mS
T5	Delay from Inhibit going High to main output voltage being within regulation.	-	-	2000	mS
T6	Delay from main output within regulation to DCOK signal assertion (going Low).	-	-	500	mS
T7	Delay from DCOK signal de-assertion (going High) to main target/regulating output dropping to less than 20%.	1	-	-	mS
T8	Delay from Inhibit assertion (Pulled low) to DCOK signal going High.	-	-	3	mS

ELECTRICAL SPECIFICATIONS

System Timing Diagram

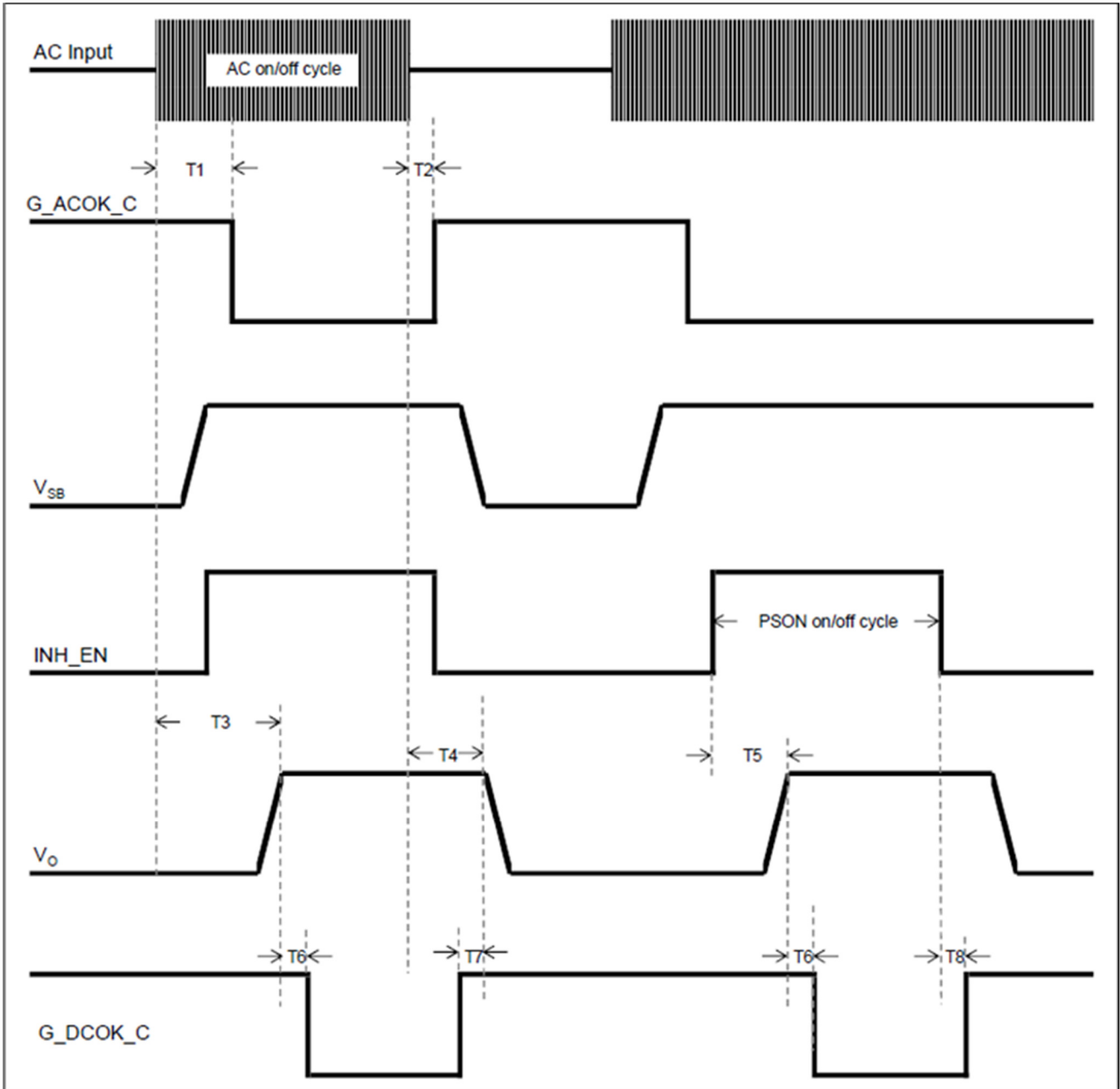

ELECTRICAL SPECIFICATIONS

LCM3000L Performance Curves

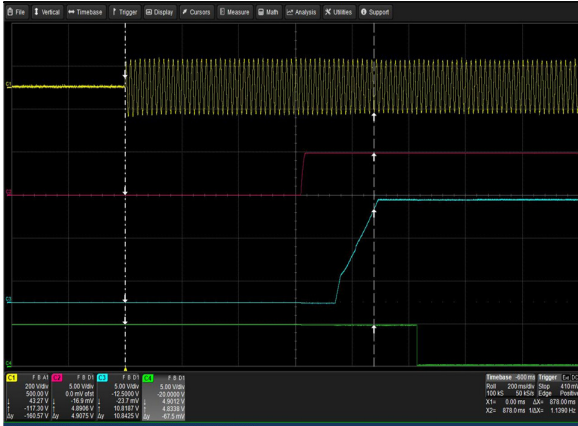

Figure 1: LCM3000L-T Turn-on delay via AC mains
 Vin = 90Vac Load: Io = 125A (12V), Isb = 2A
 Ch 1: Vin Ch 2: Vsb Ch 3: Vo Ch 4: G_DCOK_C



Figure 2: LCM3000L-T Turn-on delay via INH_EN
 Vin = 90Vac Load: Io = 125A (12V), Isb = 2A
 Ch 1: Vin Ch 2: INH_EN Ch 3: Vo Ch 4: G_DCOK_C

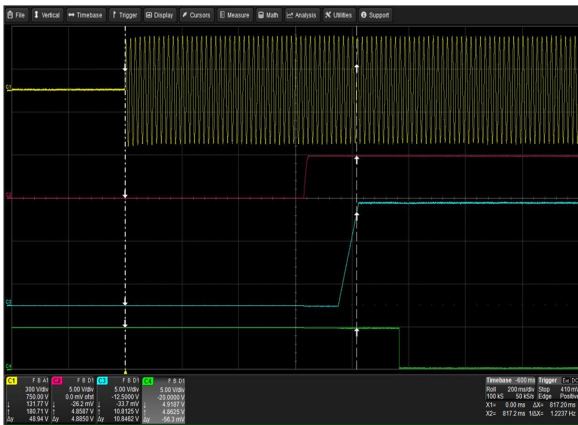

Figure 3: LCM3000L-T Turn-on delay via AC mains
 Vin = 264Vac Load: Io = 250A (12V), Isb = 2A
 Ch 1: Vin Ch 2: Vsb Ch 3: Vo Ch 4: G_DCOK_C



Figure 4: LCM3000L-T Turn-on delay via INH_EN
 Vin = 264Vac Load: Io = 250A (12V), Isb = 2A
 Ch 1: Vin Ch 2: INH_EN Ch 3: Vo Ch 4: G_DCOK_C

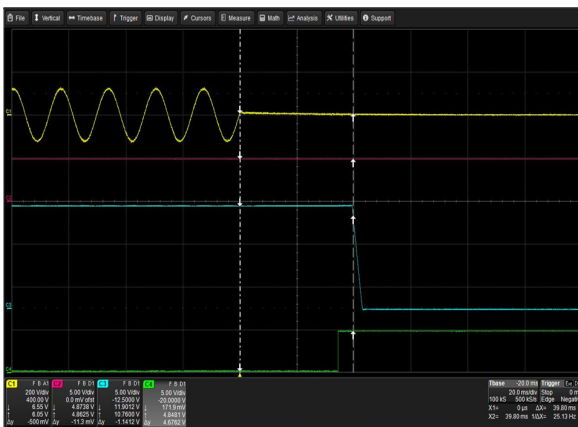

Figure 5: LCM3000L-T Hold-up Time
 Vin = 90Vac Load: Io = 125A (12V), Isb = 2A
 Ch 1: Vin Ch 2: Vsb Ch 3: Vo Ch 4: G_DCOK_C

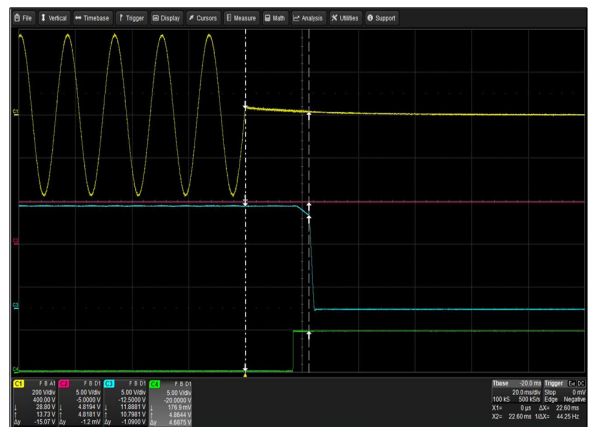

Figure 6: LCM3000L-T Hold-up Time
 Vin = 264Vac Load: Io = 250A (12V), Isb = 2A
 Ch 1: Vin Ch 2: Vsb Ch 3: Vo Ch 4: G_DCOK_C

ELECTRICAL SPECIFICATIONS

LCM3000L Performance Curves

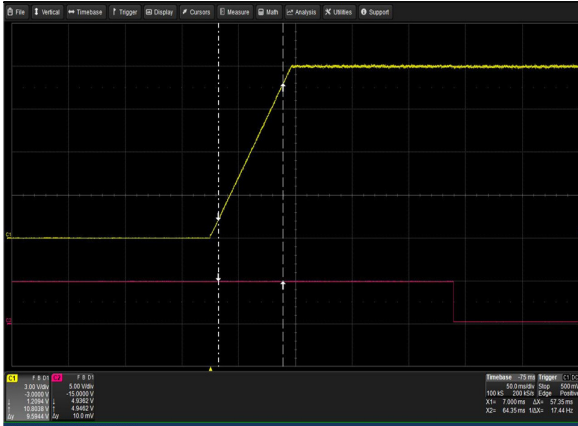

Figure 7: LCM3000L-T Output Voltage Startup
 Vin = 264Vac Load: Io = 125A (12V), Isb = 2A
 Ch 1: Vo Ch 2: G_DCOK_C



Figure 8: LCM3000L-T Turn Off Characteristic via INH_EN
 Vin = 264Vac Load: Io = 125A (12V), Isb = 2A
 Ch 1: INH_EN Ch 2: Vo Ch 3: G_DCOK_C

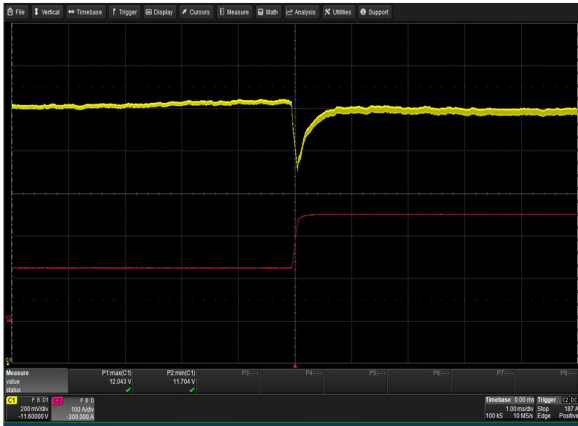

Figure 9: LCM3000L-T Transient Response - Vo Deviation
 50% to 100% load change 1A/uS slew rate Vin = 230Vac
 Ch 1: Vo Ch 2: Io

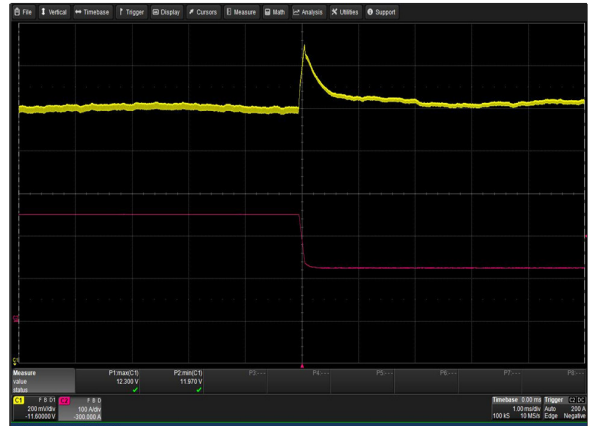

Figure 10: LCM3000L-T Transient Response - Vo Deviation
 100% to 50% load change 1A/uS slew rate Vin = 230Vac
 Ch 1: Vo Ch 2: Io

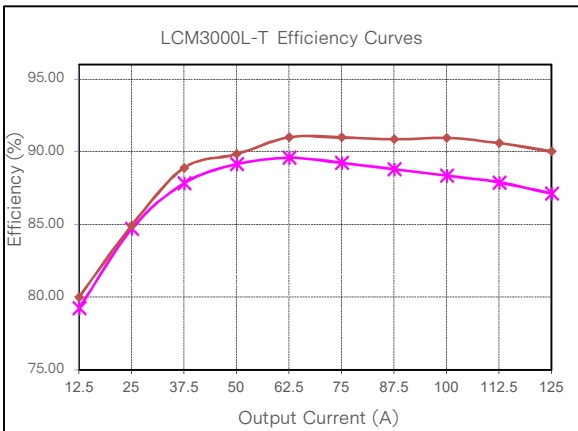

Figure 11: LCM3000L-T Efficiency Curve @ 25°C
 Loading: Io_main = 10%Io_max increment to 125A, Isb = 0A

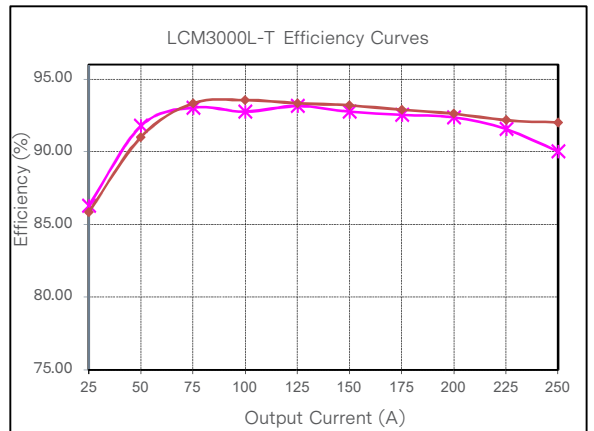
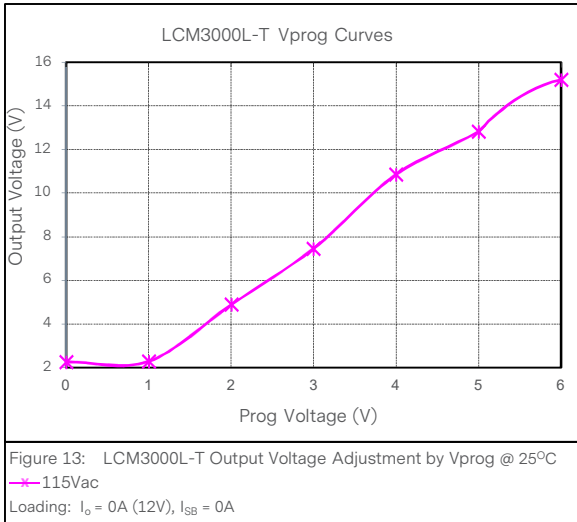

Figure 12: LCM3000L-T Efficiency Curve @ 25°C
 Loading: Io_main = 10%Io_max increment to 250A, Isb = 0A

ELECTRICAL SPECIFICATIONS

LCM3000L Performance Curves



Note: Min 1A load is required to trim the output off-line via Remote Programming or Trimming Resistor. Trimming rate is 1V/sec.

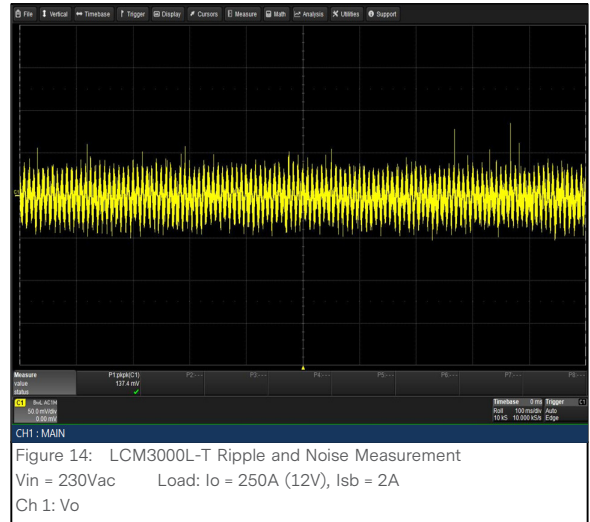

ELECTRICAL SPECIFICATIONS

LCM30008 Performance Curves

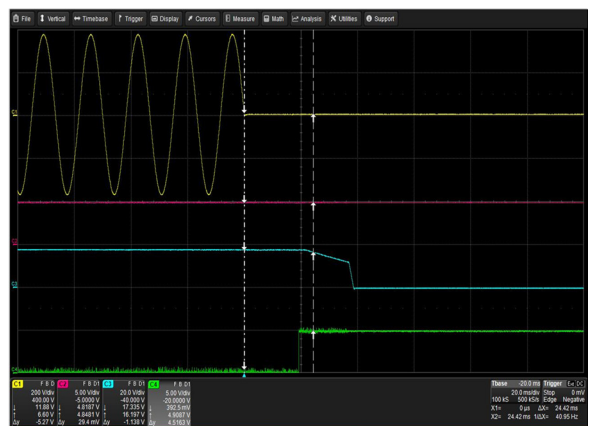
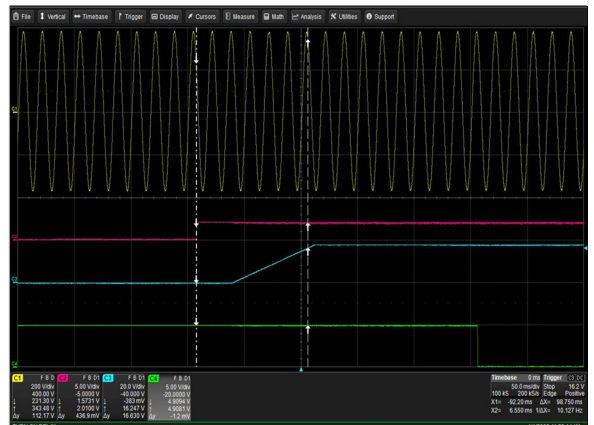
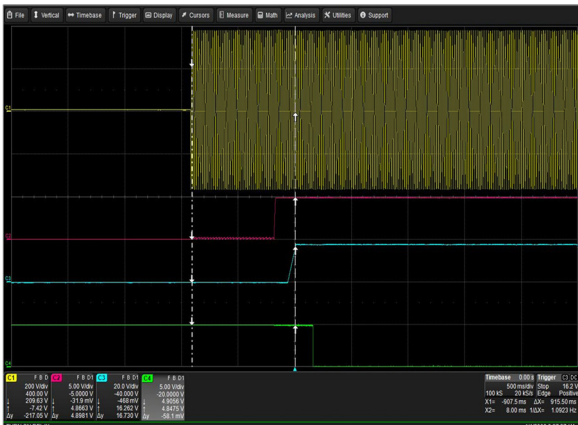
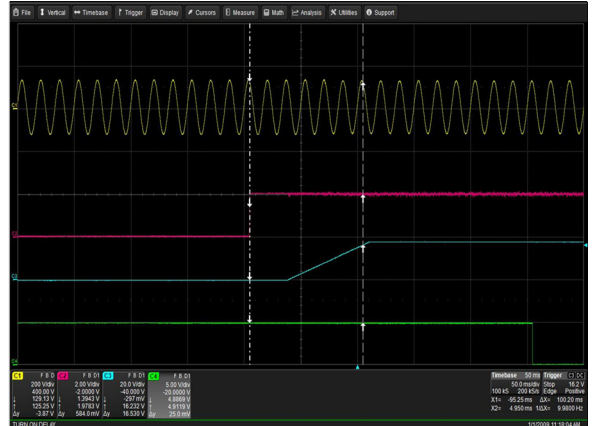
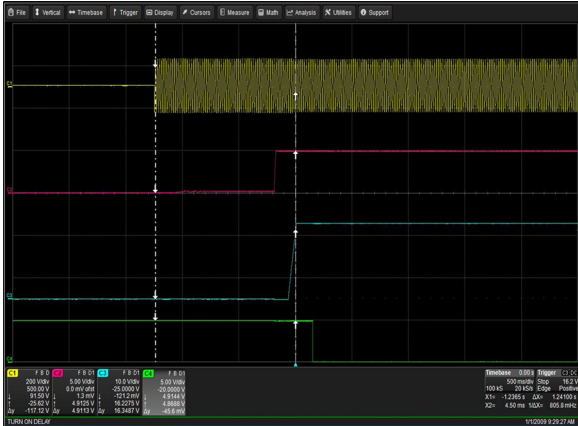

ELECTRICAL SPECIFICATIONS

LCM30008 Performance Curves

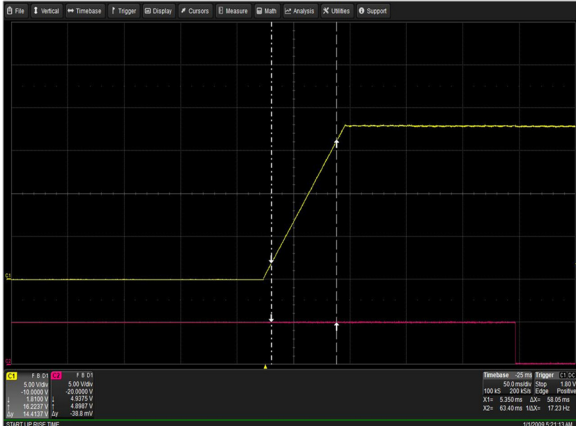

Figure 21: LCM30008-T Output Voltage Startup
 Vin = 264Vac Load: Io = 166.7A (18V), Isb = 2A
 Ch 1: Vo Ch 2: G_DCOK_C



Figure 22: LCM30008-T Turn Off Characteristic via INH_EN
 Vin = 264Vac Load: Io = 166.7A (18V), Isb = 2A
 Ch 1: INH_EN Ch 2: Vo Ch 3: G_DCOK_C

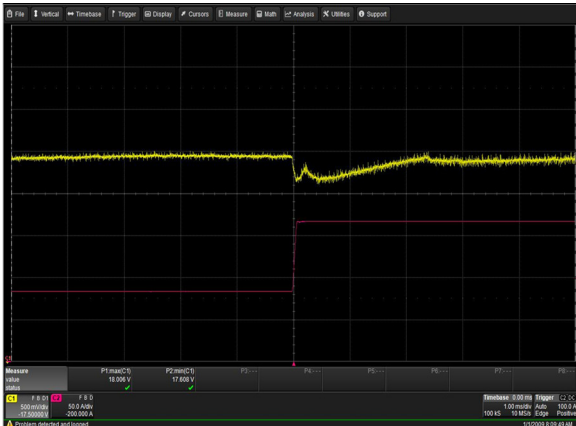

Figure 23: LCM30008-T Transient Response - Vo Deviation
 50% to 100% load change 1A/uS slew rate Vin = 230Vac
 Ch 1: Vo Ch 2: Io

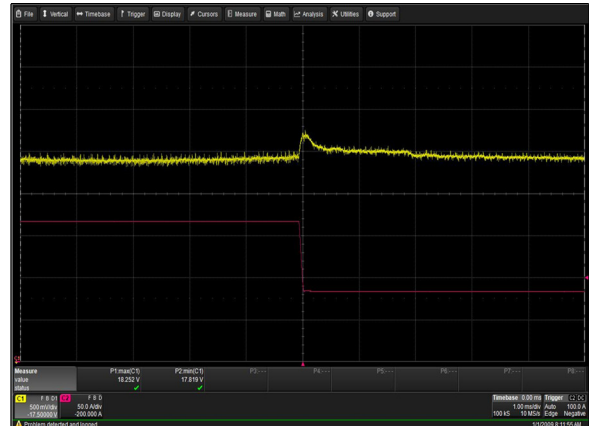

Figure 24: LCM30008-T Transient Response - Vo Deviation
 100% to 50% load change 1A/uS slew rate Vin = 230Vac
 Ch 1: Vo Ch 2: Io

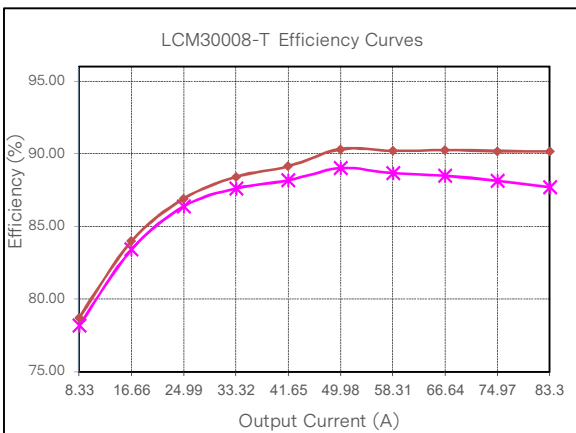

Figure 25: LCM30008-T Efficiency Curve @ 25°C
 Loading: Io_main = 10%Io_max increment to 83.3A, Isb = 0A

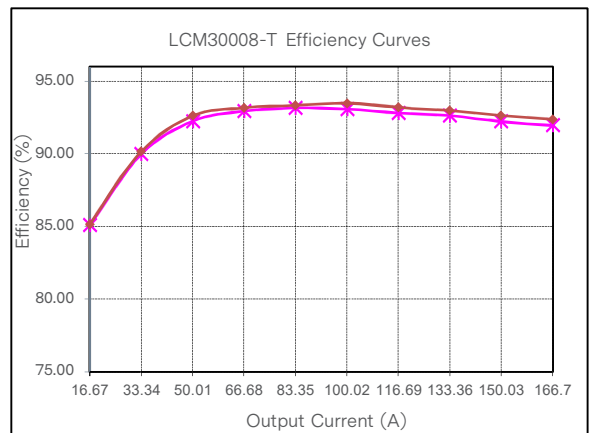
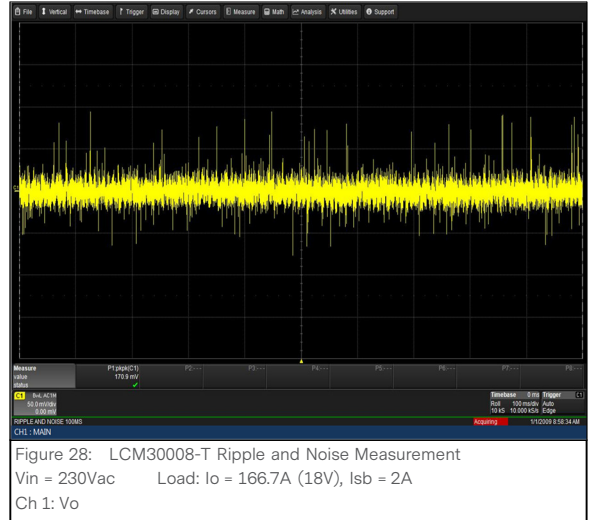
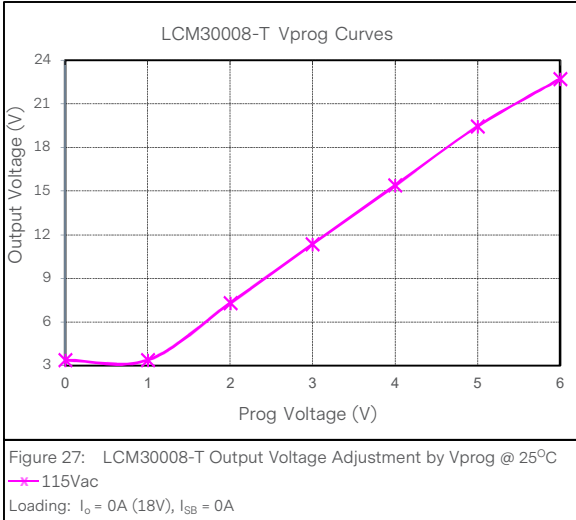

Figure 26: LCM30008-T Efficiency Curve @ 25°C
 Loading: Io_main = 10%Io_max increment to 166.7A, Isb = 0A

ELECTRICAL SPECIFICATIONS

LCM30008 Performance Curves



Note: Min 1A load is required to trim the output off-line via Remote Programming or Trimming Resistor. Trimming rate is 1V/sec.

ELECTRICAL SPECIFICATIONS

LCM3000Q Performance Curves

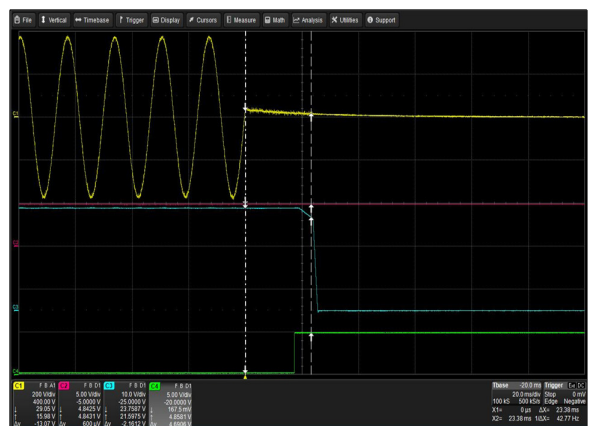
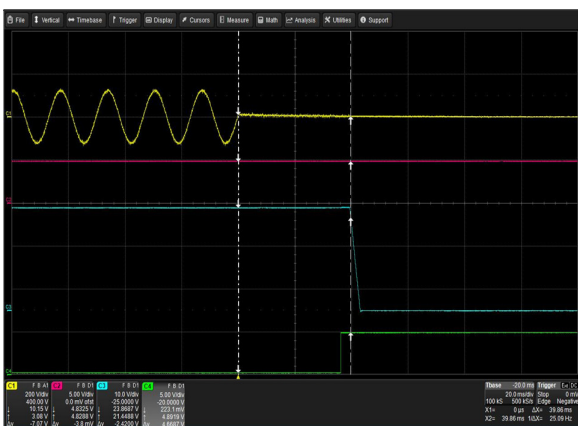
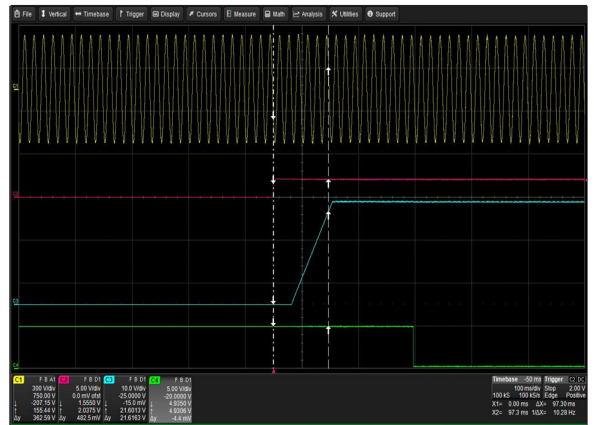
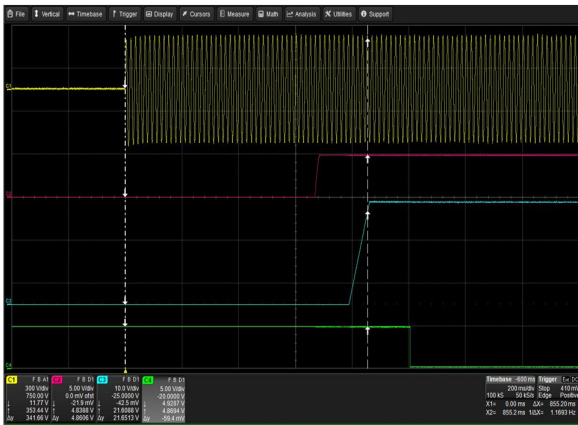
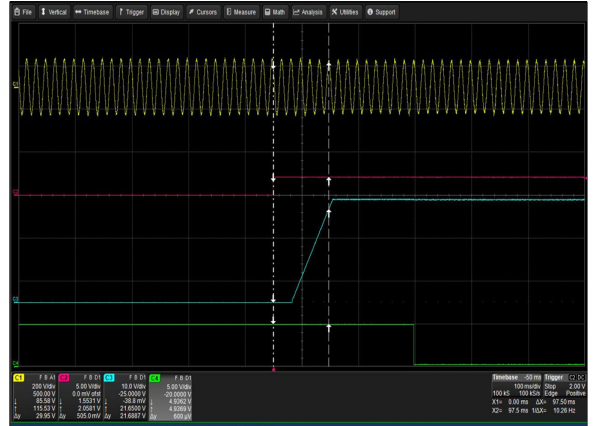
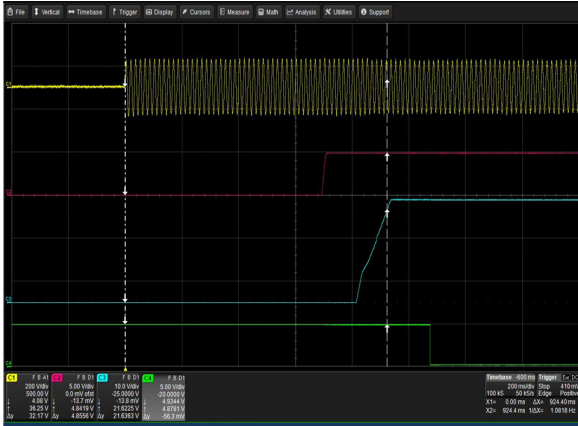

ELECTRICAL SPECIFICATIONS

LCM3000Q Performance Curves

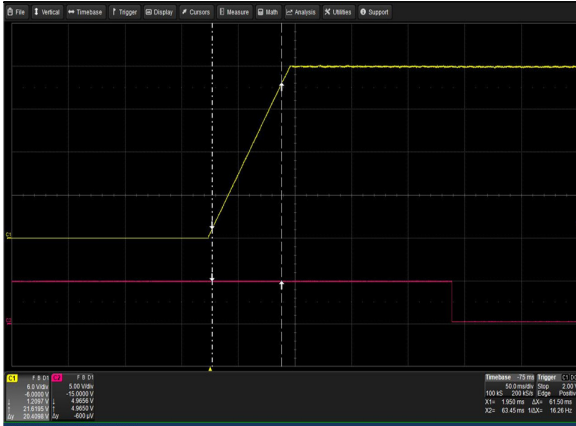

Figure 35: LCM3000Q-T Output Voltage Startup
 Vin = 264Vac Load: Io = 125A (24V), Isb = 2A
 Ch 1: Vo Ch 2: G_DCOK_C



Figure 36: LCM3000Q-T Turn Off Characteristic via INH_EN
 Vin = 264Vac Load: Io = 125A (24V), Isb = 2A
 Ch 1: INH_EN Ch 2: Vo Ch 3: G_DCOK_C

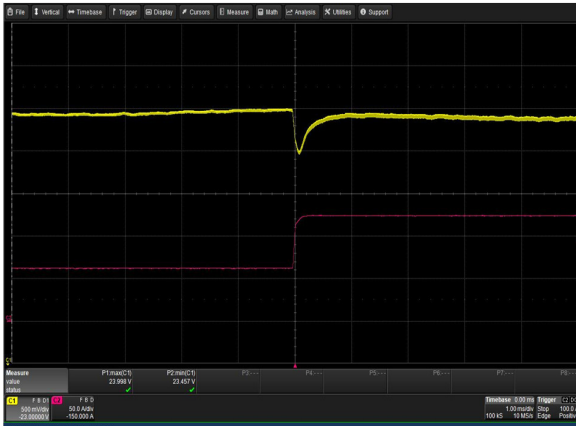

Figure 37: LCM3000Q-T Transient Response - Vo Deviation
 50% to 100% load change 1A/uS slew rate Vin = 230Vac
 Ch 1: Vo Ch 2: Io

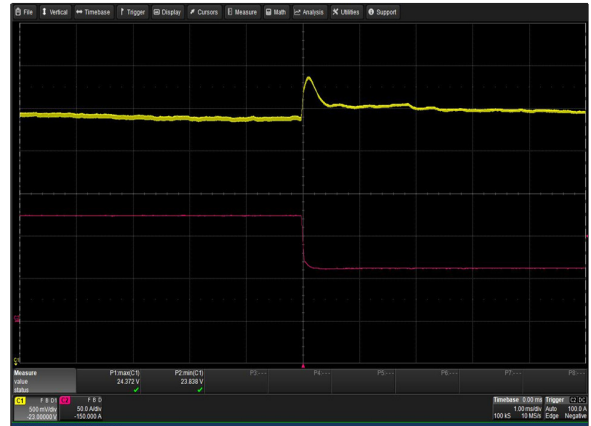

Figure 38: LCM3000Q-T Transient Response - Vo Deviation
 100% to 50% load change 1A/uS slew rate Vin = 230Vac
 Ch 1: Vo Ch 2: Io

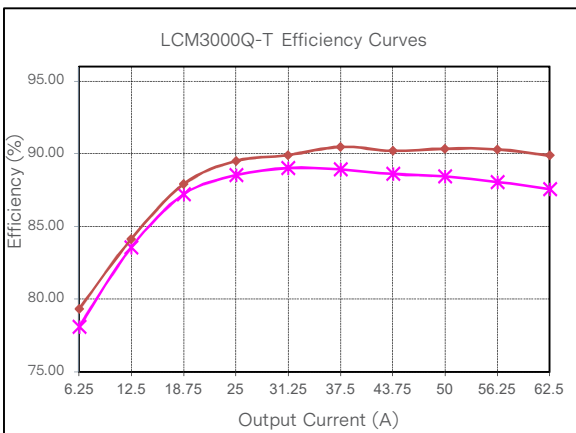

Figure 39: LCM3000Q-T Efficiency Curve @ 25°C
 Loading: Io_main = 10%Io_max increment to 62.5A, Isb = 0A

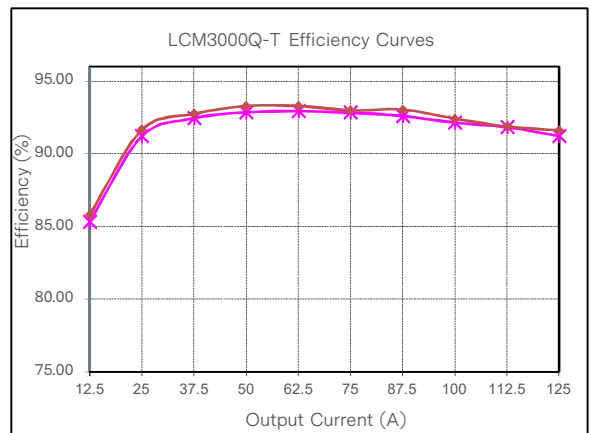
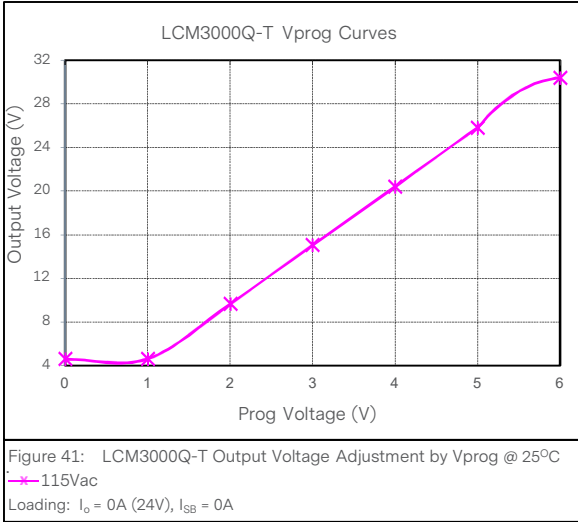

Figure 40: LCM3000Q-T Efficiency Curve @ 25°C
 Loading: Io_main = 10%Io_max increment to 125A, Isb = 0A

ELECTRICAL SPECIFICATIONS

LCM3000Q Performance Curves



Note: Min 1A load is required to trim the output off-line via Remote Programming or Trimming Resistor. Trimming rate is 1V/sec.

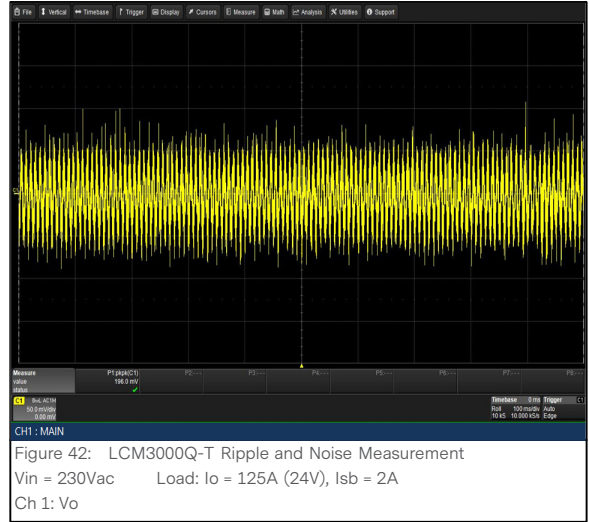

ELECTRICAL SPECIFICATIONS

LCM3000U Performance Curves

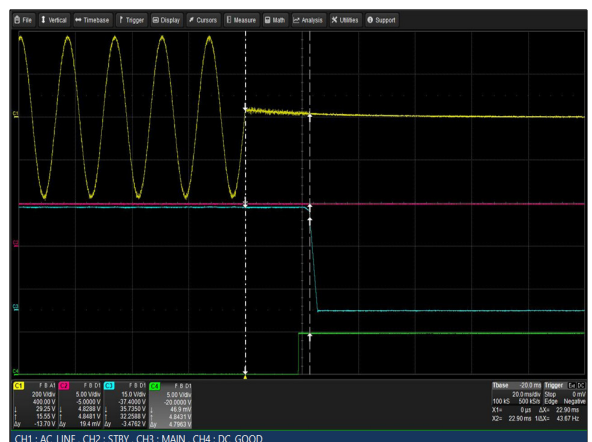
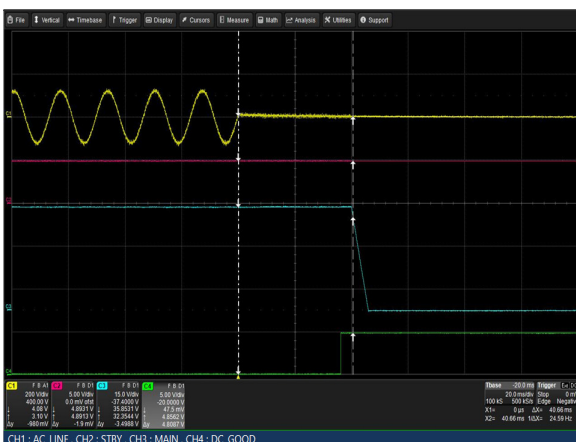
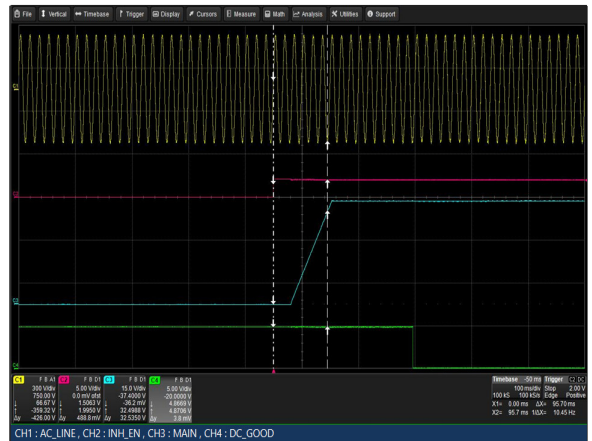
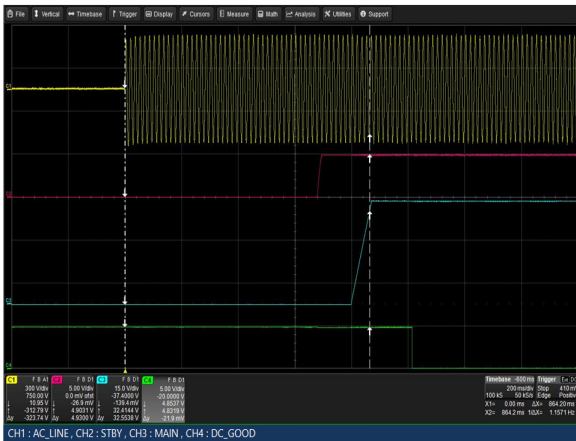
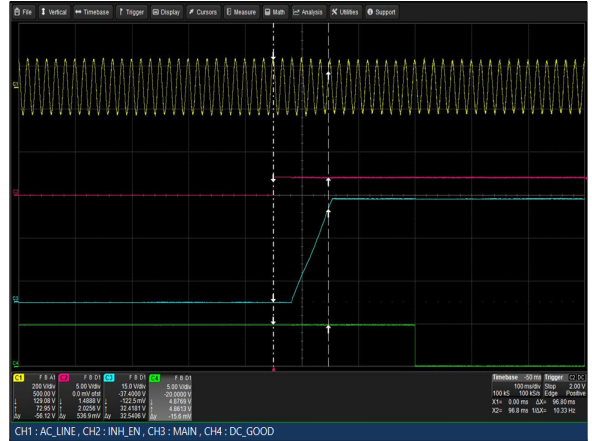
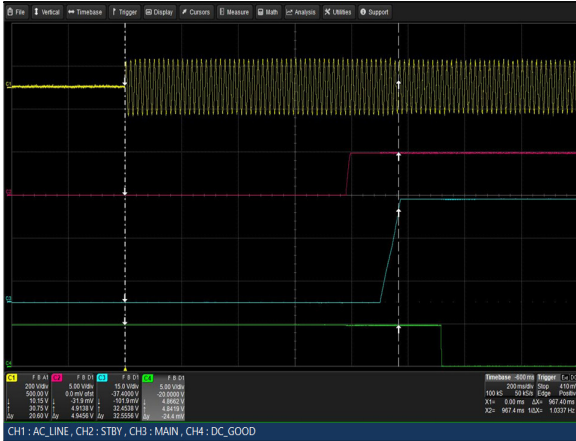

ELECTRICAL SPECIFICATIONS

LCM3000U Performance Curves

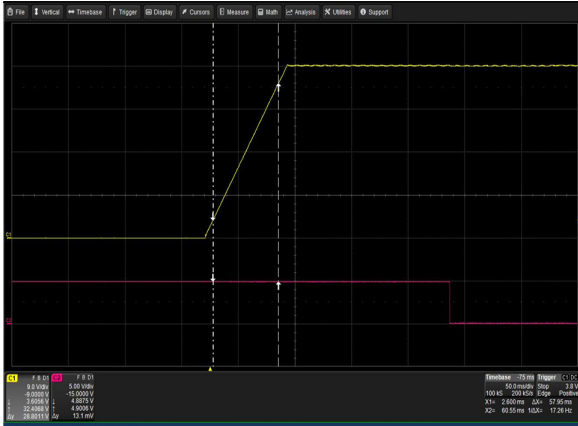

Figure 49: LCM3000U-T Output Voltage Startup
 Vin = 264Vac Load: Io = 83.3A (36V), Isb = 2A
 Ch 1: Vo Ch 2: G_DCOK_C



Figure 50: LCM3000U-T Turn Off Characteristic via INH_EN
 Vin = 264Vac Load: Io = 83.3A (36V), Isb = 2A
 Ch 1: INH_EN Ch 2: Vo Ch 3: G_DCOK_C



Figure 51: LCM3000U-T Transient Response - Vo Deviation
 50% to 100% load change 1A/uS slew rate Vin = 230Vac
 Ch 1: Vo Ch 2: Io

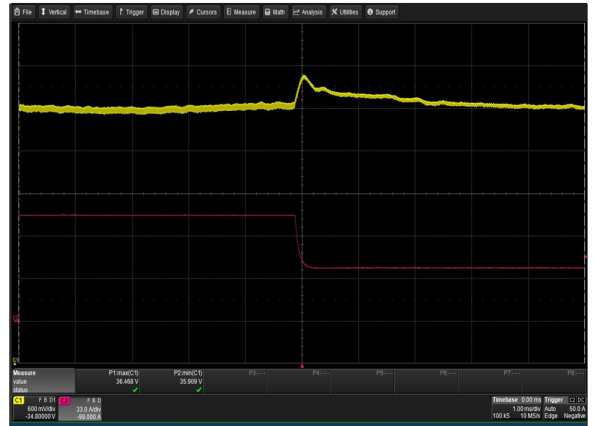

Figure 52: LCM3000U-T Transient Response - Vo Deviation
 100% to 50% load change 1A/uS slew rate Vin = 230Vac
 Ch 1: Vo Ch 2: Io

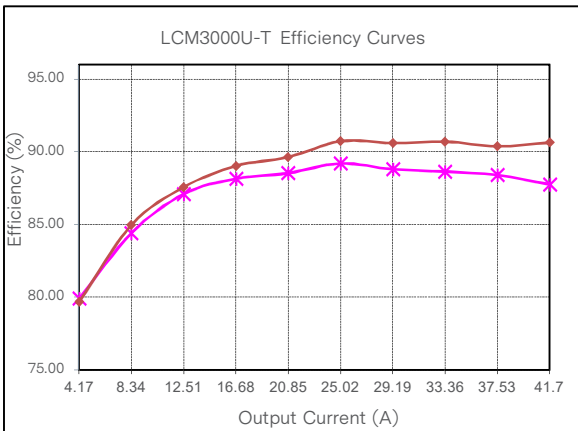

Figure 53: LCM3000U-T Efficiency Curve @ 25°C
 Loading: Io_main = 10%Io_max increment to 41.7A, Isb = 0A
 ◆ 115Vac ◆ 90Vac

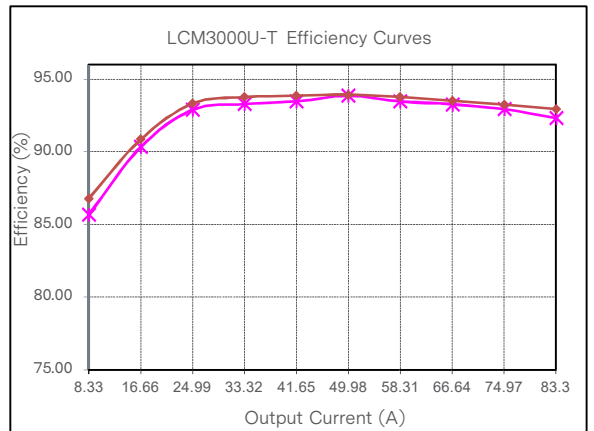
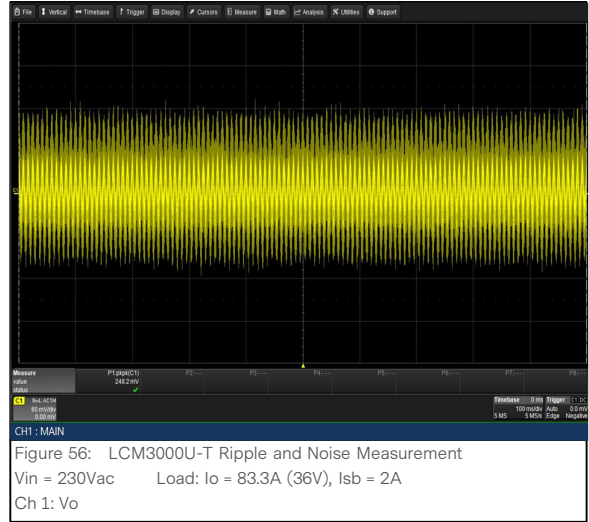
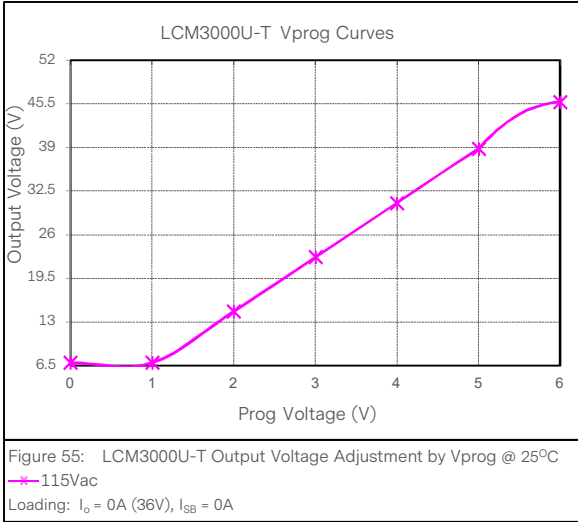

Figure 54: LCM3000U-T Efficiency Curve @ 25°C
 Loading: Io_main = 10%Io_max increment to 83.3A, Isb = 0A
 ◆ 264Vac ◆ 230Vac

ELECTRICAL SPECIFICATIONS

LCM3000U Performance Curves



Note: Min 1A load is required to trim the output off-line via Remote Programming or Trimming Resistor. Trimming rate is 1V/sec.

ELECTRICAL SPECIFICATIONS

LCM3000W Performance Curves

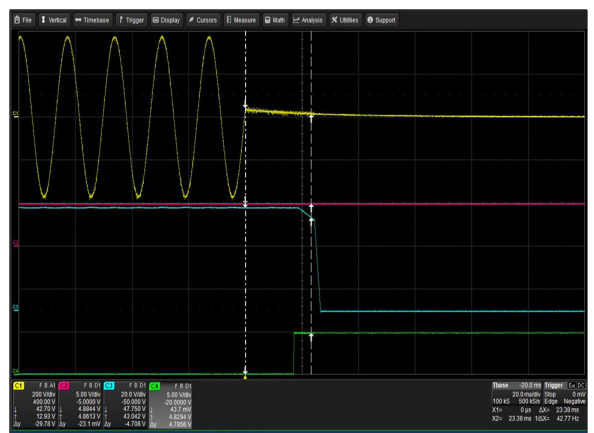
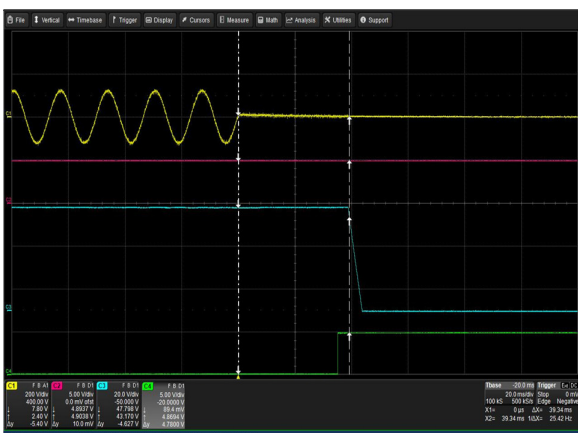
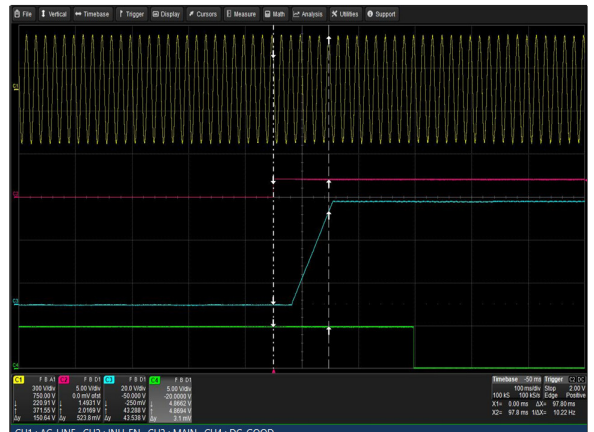
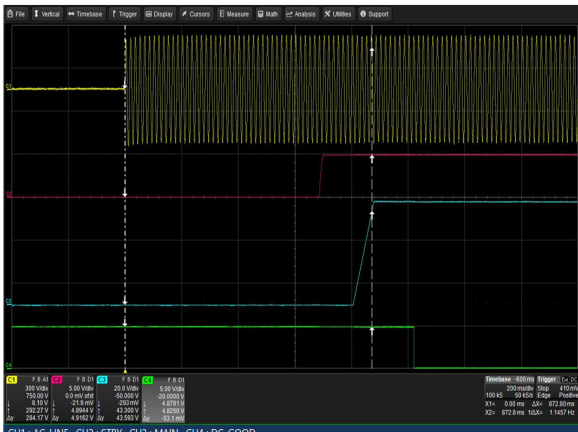
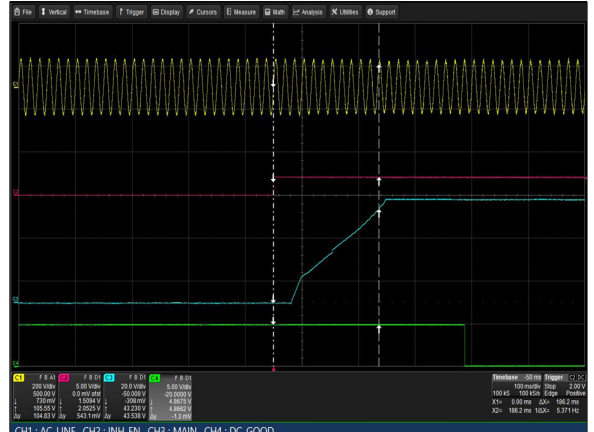
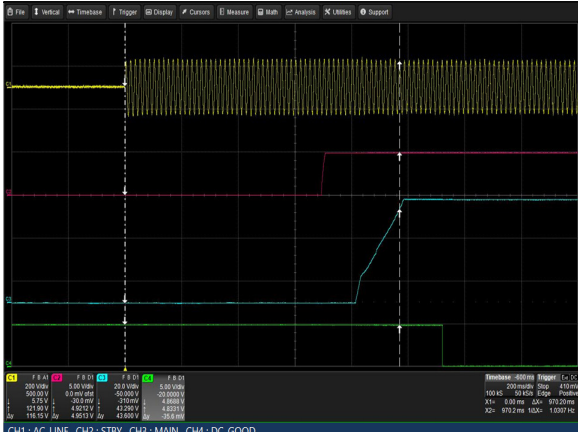

ELECTRICAL SPECIFICATIONS

LCM3000W Performance Curves

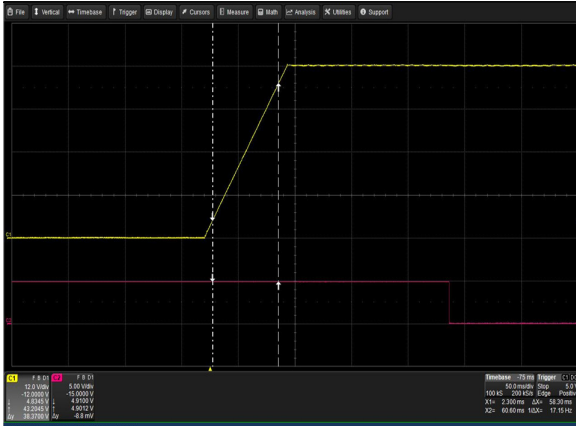

Figure 63: LCM3000W-T Output Voltage Startup
 Vin = 264Vac Load: Io = 62.5A (48V), Isb = 2A
 Ch 1: Vo Ch 2: G_DCOK_C



Figure 64: LCM3000W-T Turn Off Characteristic via INH_EN
 Vin = 264Vac Load: Io = 62.5A (48V), Isb = 2A
 Ch 1: INH_EN Ch 2: Vo Ch 3: G_DCOK_C

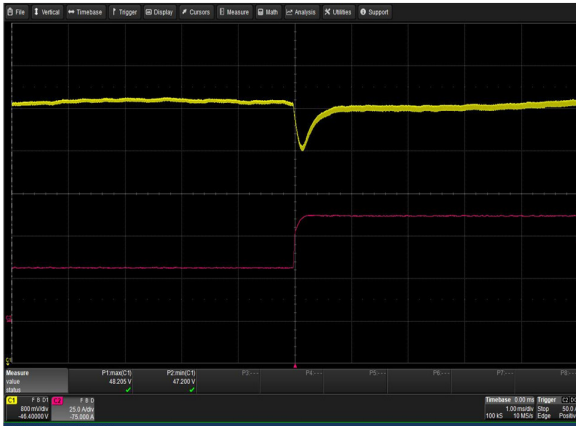

Figure 65: LCM3000W-T Transient Response - Vo Deviation
 50% to 100% load change 1A/uS slew rate Vin = 230Vac
 Ch 1: Vo Ch 2: Io

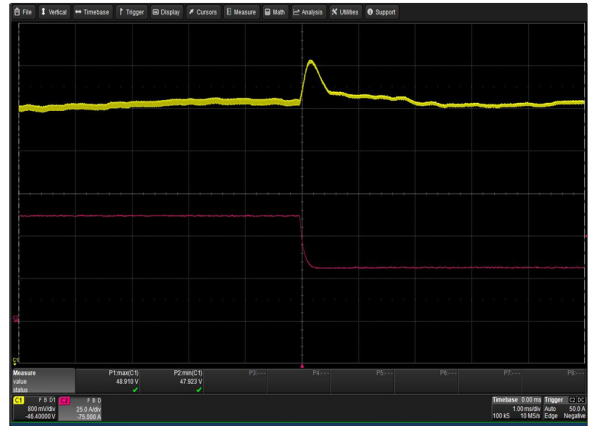

Figure 66: LCM3000W-T Transient Response - Vo Deviation
 100% to 50% load change 1A/uS slew rate Vin = 230Vac
 Ch 1: Vo Ch 2: Io

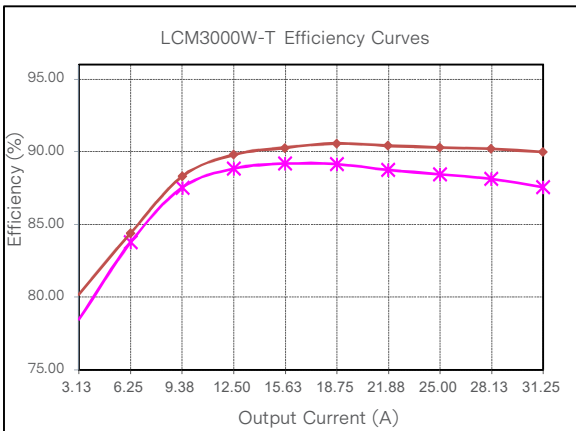

Figure 67: LCM3000W-T Efficiency Curve @ 25°C
 Loading: Io_main = 10%Io_max increment to 31.25A, Isb = 0A

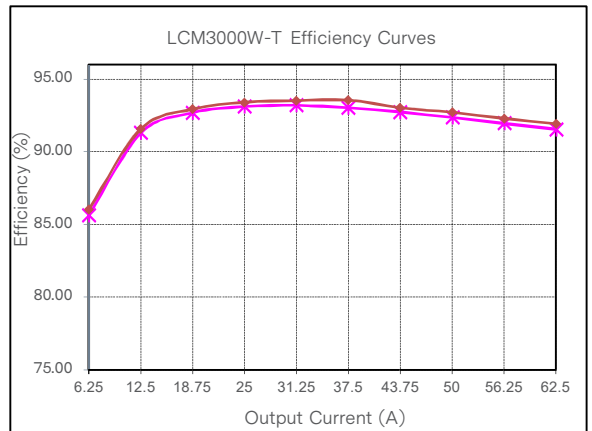
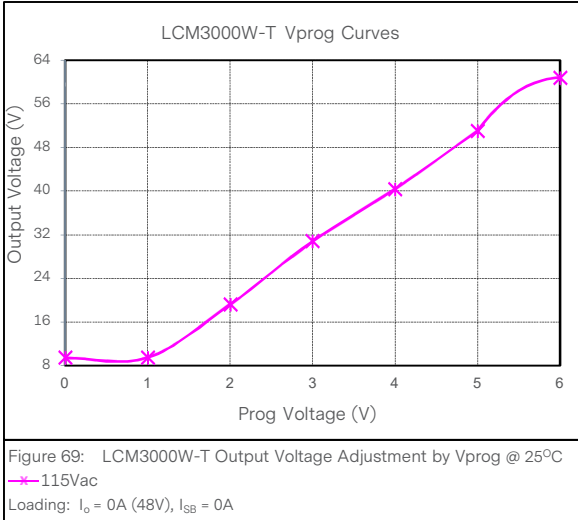

Figure 68: LCM3000W-T Efficiency Curve @ 25°C
 Loading: Io_main = 10%Io_max increment to 62.5A, Isb = 0A

ELECTRICAL SPECIFICATIONS

LCM3000W Performance Curves



Note: Min 1A load is required to trim the output off-line via Remote Programming or Trimming Resistor. Trimming rate is 1V/sec.

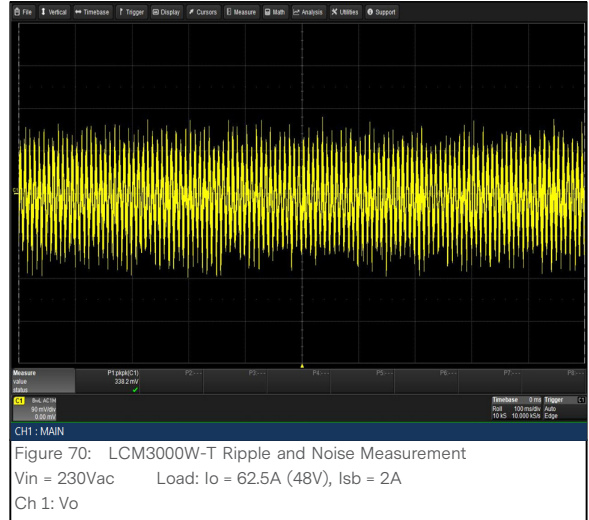

ELECTRICAL SPECIFICATIONS

LCM30007 Performance Curves

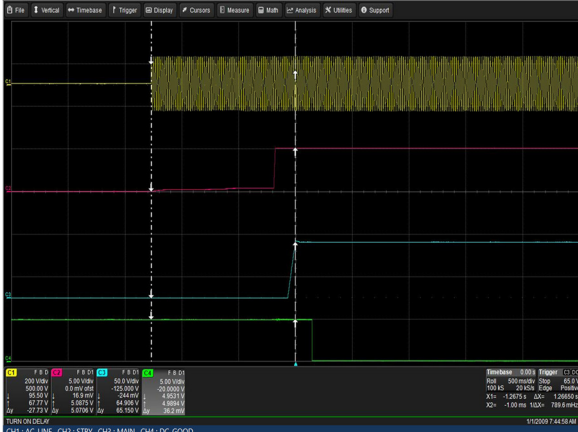

Figure 71: LCM30007-T Turn-on delay via AC mains
 Vin = 90Vac Load: lo = 20.8A (72V), Isb = 2A
 Ch 1: Vin Ch 2: Vsb Ch 3: Vo Ch 4: G_DCOK_C

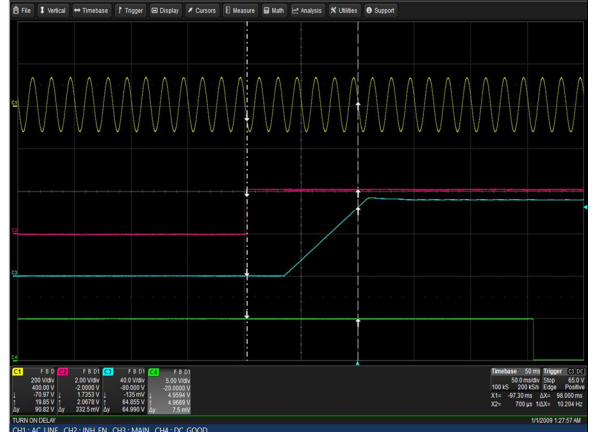

Figure 72: LCM30007-T Turn-on delay via INH_EN
 Vin = 90Vac Load: lo = 20.8A (72V), Isb = 2A
 Ch 1: Vin Ch 2: INH_EN Ch 3: Vo Ch 4: G_DCOK_C

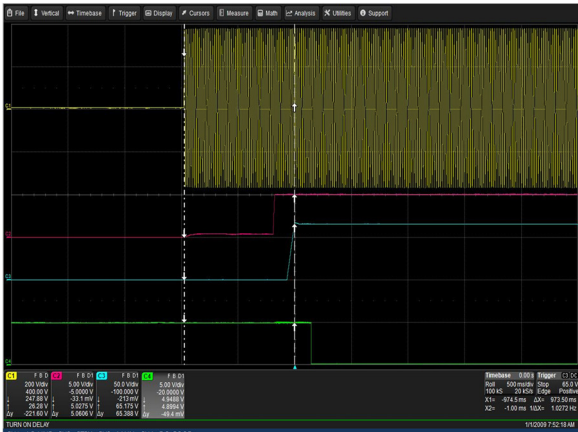

Figure 73: LCM30007-T Turn-on delay via AC mains
 Vin = 264Vac Load: lo = 41.7A (72V), Isb = 2A
 Ch 1: Vin Ch 2: Vsb Ch 3: Vo Ch 4: G_DCOK_C

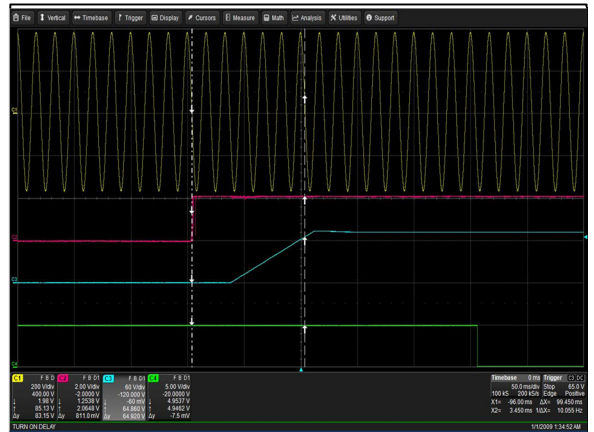

Figure 74: LCM30007-T Turn-on delay via INH_EN
 Vin = 264Vac Load: lo = 41.7A (72V), Isb = 2A
 Ch 1: Vin Ch 2: INH_EN Ch 3: Vo Ch 4: G_DCOK_C



Figure 75: LCM30007-T Hold-up Time
 Vin = 90Vac Load: lo = 20.8A (72V), Isb = 2A
 Ch 1: Vin Ch 2: Vsb Ch 3: Vo Ch 4: G_DCOK_C

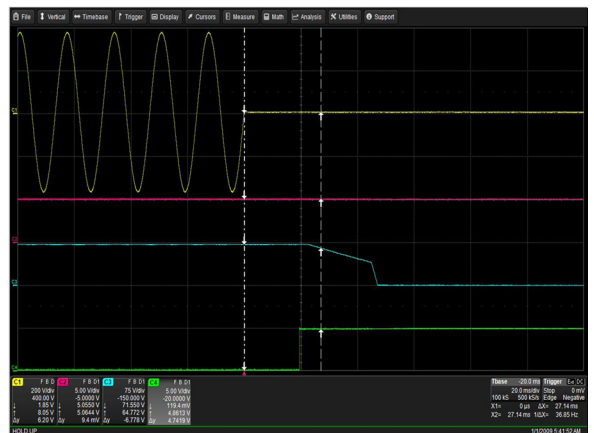

Figure 76: LCM30007-T Hold-up Time
 Vin = 264Vac Load: lo = 41.7A (72V), Isb = 2A
 Ch 1: Vin Ch 2: Vsb Ch 3: Vo Ch 4: G_DCOK_C

ELECTRICAL SPECIFICATIONS

LCM30007 Performance Curves



Figure 77: LCM30007-T Output Voltage Startup
 Vin = 264Vac Load: Io = 41.7A (72V), Isb = 2A
 Ch 1: Vo Ch 2: G_DCOK_C



Figure 78: LCM30007-T Turn Off Characteristic via INH_EN
 Vin = 264Vac Load: Io = 41.7A (72V), Isb = 2A
 Ch 1: INH_EN Ch 2: Vo Ch 3: G_DCOK_C

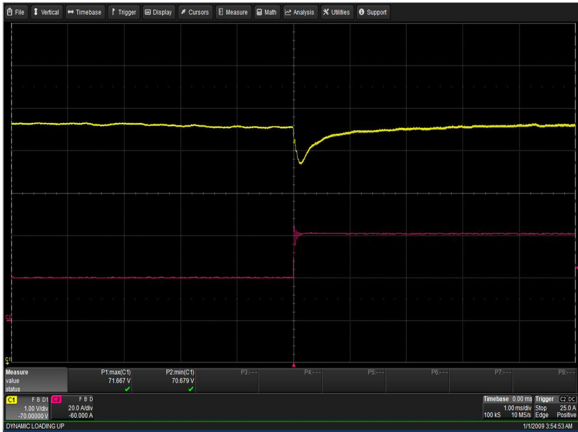

Figure 79: LCM30007-T Transient Response - Vo Deviation
 50% to 100% load change 1A/uS slew rate Vin = 230Vac
 Ch 1: Vo Ch 2: Io

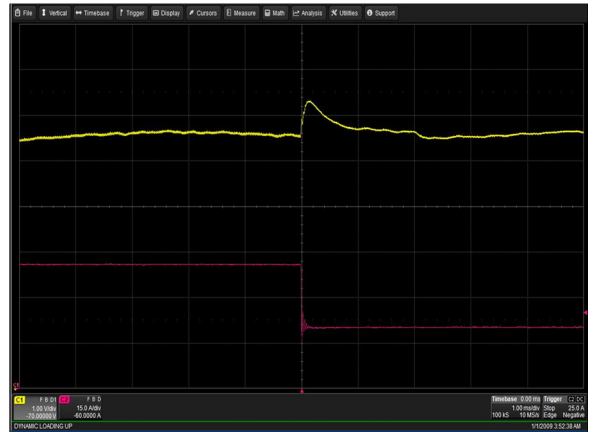

Figure 80: LCM30007-T Transient Response - Vo Deviation
 100% to 50% load change 1A/uS slew rate Vin = 230Vac
 Ch 1: Vo Ch 2: Io

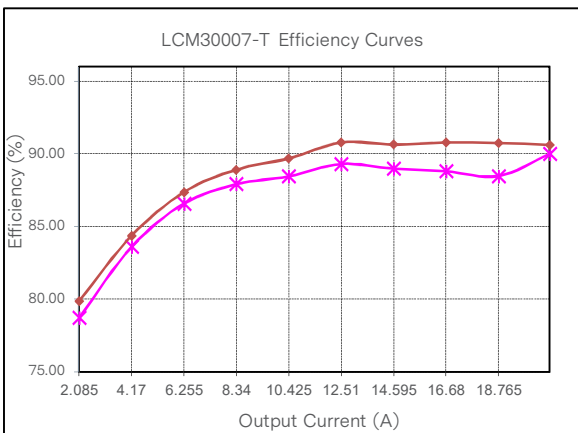

Figure 81: LCM30007-T Efficiency Curve @ 25°C
 Loading: Io_main = 10%Io_max increment to 20.8A, Isb = 0A

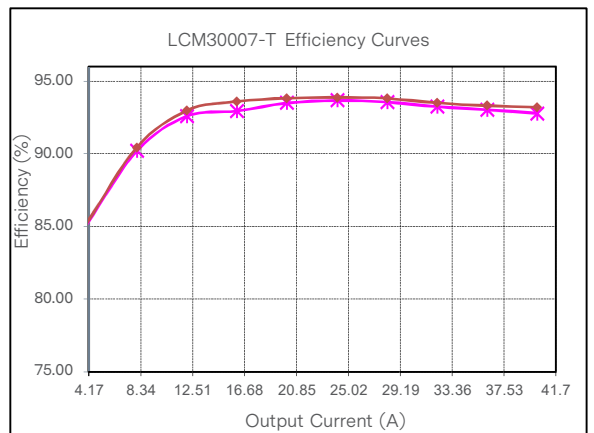
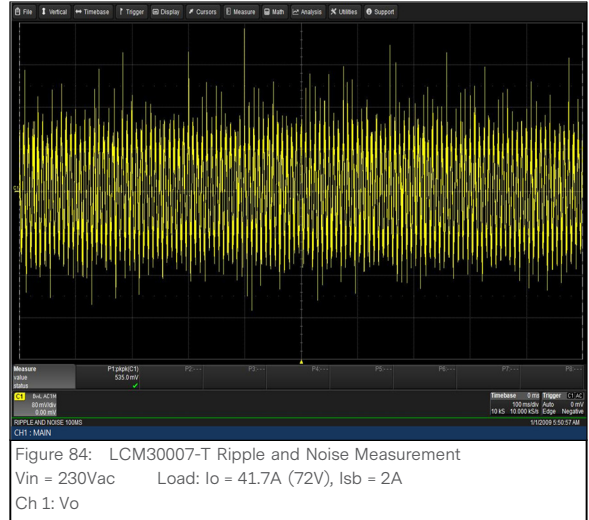
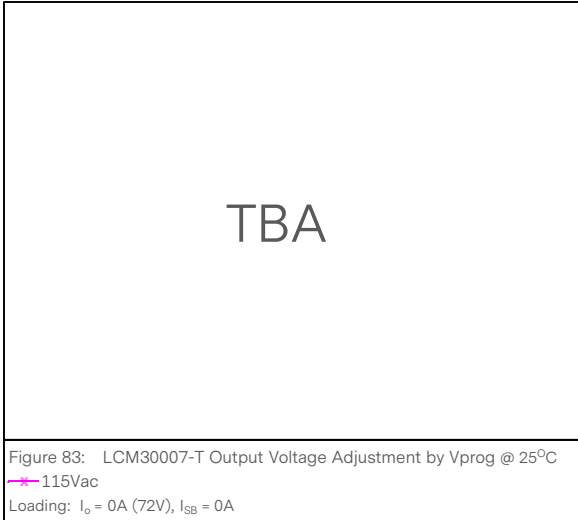

Figure 82: LCM30007-T Efficiency Curve @ 25°C
 Loading: Io_main = 10%Io_max increment to 41.7A, Isb = 0A

ELECTRICAL SPECIFICATIONS

LCM30007 Performance Curves



Note: Min 1A load is required to trim the output off-line via Remote Programming or Trimming Resistor. Trimming rate is 1V/sec.

ELECTRICAL SPECIFICATIONS

Protection Function Specifications

Input Fuse

LCM3000 series is equipped with an internal non user serviceable 30A High Rupturing Capacity (HRC) 250 Vac fuse to IEC 127 for fault protection in both the Line and Neutral lines input.

Over Voltage Protection (OVP)

The power supply latches off during output overvoltage with the AC line recycled to reset the latch.

Parameter	Min	Typ	Max	Unit
V _O Output Overvoltage	110	/	130	% V _O
Standby Voltage Overvoltage	110	/	125	% V _O

Over Current Protection (OCP)

LCM3000 series includes internal current limit circuitry to prevent damage in the event of overload or short circuit. Constant current mode before output voltage falls below 35% of nominal. Recovery is automatic when the overload is removed. Bounce period is 1 second.

Over current protection on 5V standby output will shutdown main DC output but any fault in main output will not affect standby output.

Parameter	Min	Typ	Max	Unit
V _O Output Overcurrent	105	/	125	% I _{O,max}
Standby Voltage Overcurrent	120	/	140	% I _{O,max}

Short Circuit Protection (SCP)

A short circuit is defined as less than 0.03 ohm resistance between the output terminals. All outputs will be protected against short circuit to ground or other outputs. No damage will be resulted. In the event of short circuit, output will be in bouncing mode with a recovery delay of 1Sec. Optional 5V standby, independent of the main output, will also be in bouncing mode once the fault occurred.

Over Temperature Protection (OTP)

The power supply will be internally protected against over temperature conditions. When the OTP circuit is activated, the power supply will shut off and will auto-recover once the OTP condition is gone. OTP trip-point at full Load is set at a nominal of 10 - 15°C above safe operating area.

MECHANICAL SPECIFICATIONS

Mechanical Outlines (unit: mm)

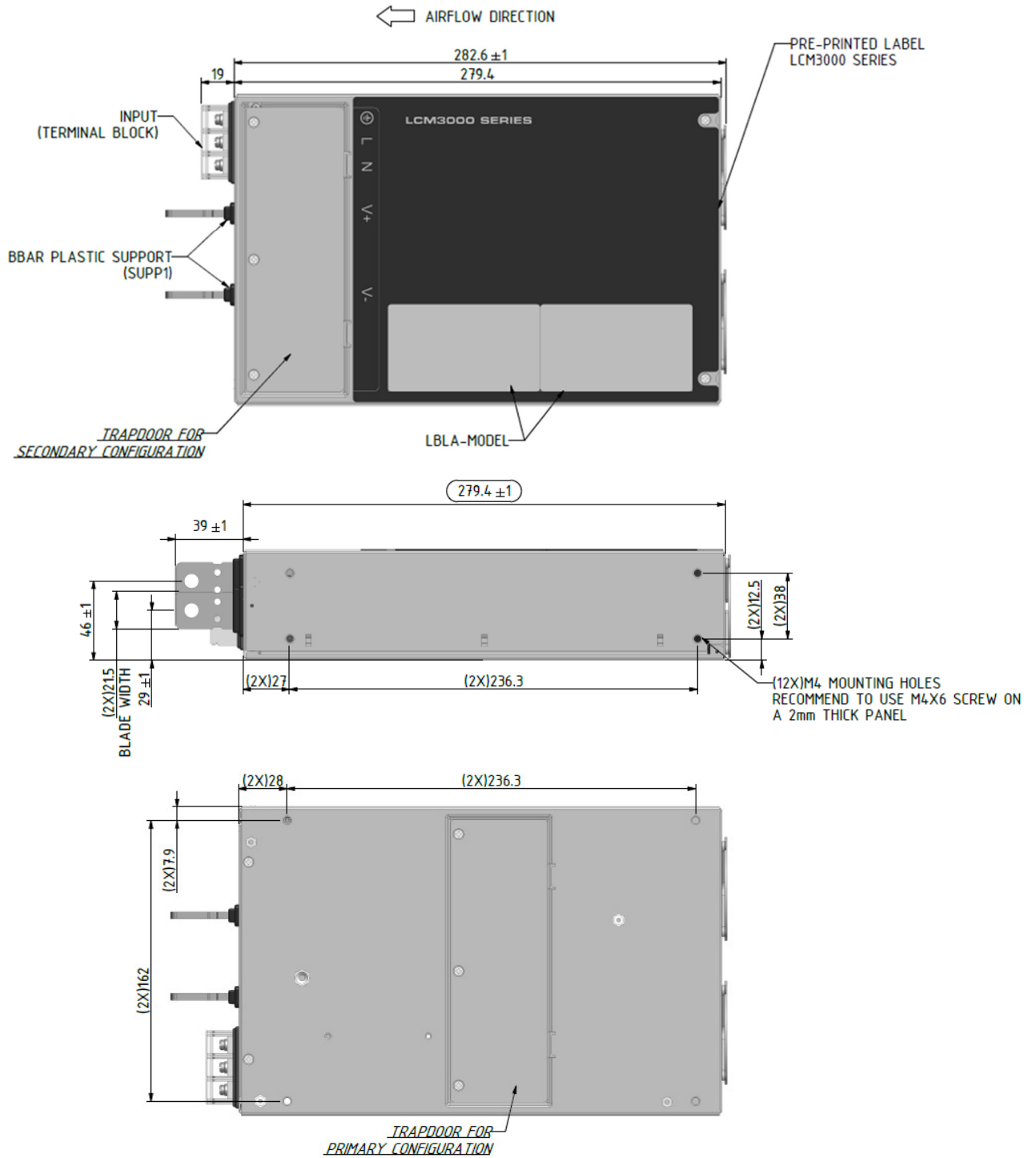

MECHANICAL SPECIFICATIONS

Mechanical Outlines (unit: mm)

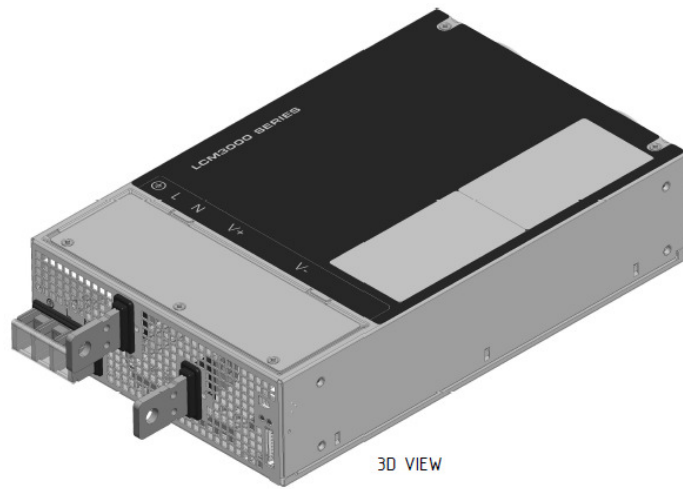
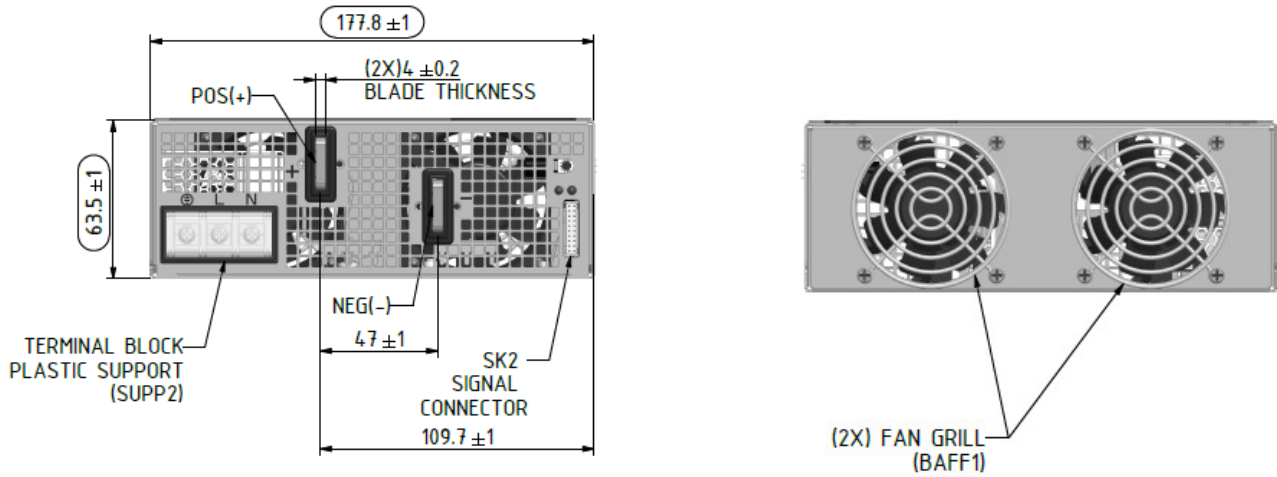

Note: For customer mounting, Dimension should be from external surface. Max screw protrusion will be 4.5mm (1.0mm chassis thickness)

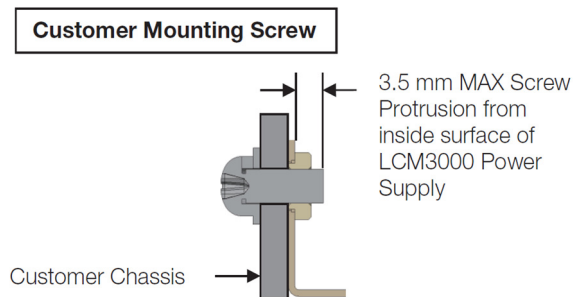

MECHANICAL SPECIFICATIONS

Connector Definitions

AC Input Connector - SK1

⊕ – Earth Ground

L – Line

N – Neutral

Output Connector – SK3&SK4

SK3 – Main Output (Vo)

SK4 – Main Output Return

Output Connector – SK2

Pin 1 – A2

Pin 2 – -VPROG

Pin 3 – A1

Pin 4 – -VSENSE

Pin 5 – -ISHARE

Pin 6 – A0

Pin 7 – SDA1

Pin 8 – +VPROG

Pin 9 – SCL1

Pin 10 – +VSENSE

Pin 11 – 5VSB

Pin 12 – GND

Pin 13 – 5VSB

Pin 14 – G_DCOK_C

Pin 15 – GPIOA6

Pin 16 – G_DCOK_E

Pin 17 – GND

Pin 18 – G_ACOK_C

Pin 19 – INH_EN

Pin 20 – G_ACOK_E

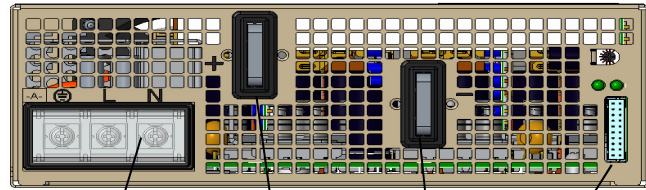

SK1

SK3

SK4

SK2

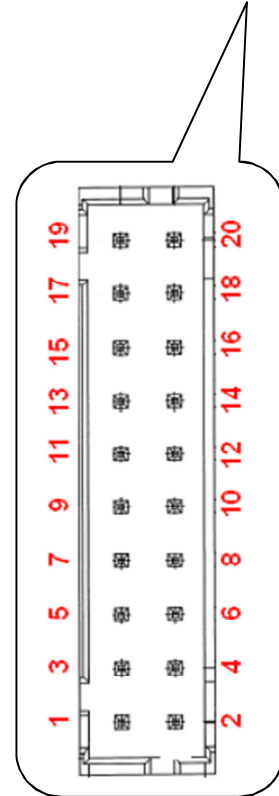

MECHANICAL SPECIFICATIONS

Potentiometer Location

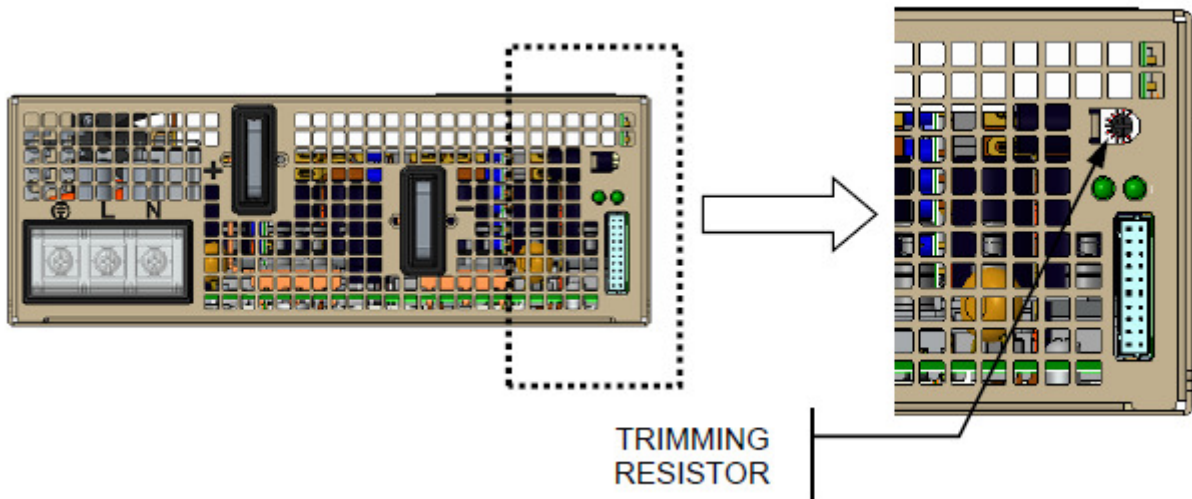

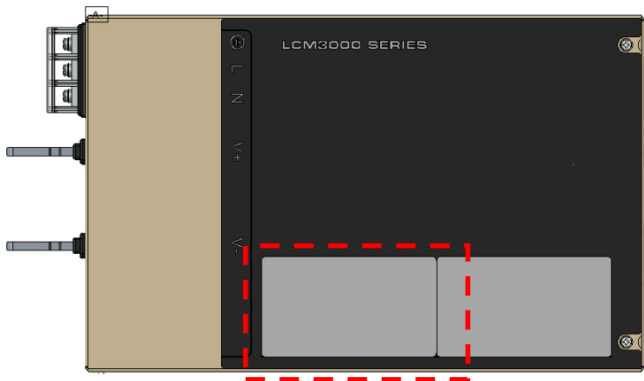

Label Location



SWITCHING POWER SUPPLY -XXX
 MODEL : LCM3000X-T

INPUT	OUTPUT
100 - 240V ~ 20A MAX; 50/60Hz	+XXV-XXV == XXA MAX (1500W MAX) +5Vsb == 2A MAX SET TO +XXV == XXA MAX
200 - 240V ~ 20A MAX; 50/60Hz	+XXV-XXV == XXA MAX (3000W MAX) +5Vsb == 2A MAX SET TO +XXV == XXA MAX

Config Serial Number

 MMMMWSSSRLL

13890

MECHANICAL SPECIFICATIONS

Power / Signal Mating Connectors and Pin Types

Table 5. Mating Connectors for LCM3000 Series		
Reference	On Power Supply	Mating Connector or Equivalent
AC Input Connector	451-004155-0000 (TERM-BLOCK DT-7C-B14W-03)	M4 Screw
SK2	CI0120P1HD0-LF	LANDWIN (LWE PN: 2050S) Housing (LWE PN: 2053T) Contact CVILUX (CX PN: CI0120SD000) Housing (CX PN: CI01TD21PE0) Contact
SK3, SK4	500-008156-0004 (BBAR O/P LCM3000)	Clearance hole diameter ϕ 8.5

MECHANICAL SPECIFICATIONS

LED Indicator Definitions

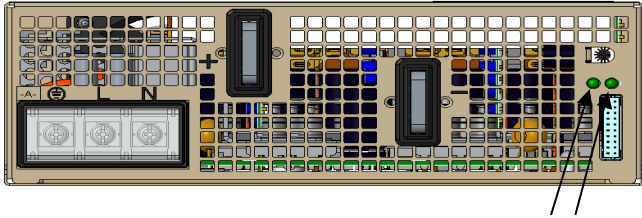

ACOK DCOK/FAIL

Two user-friendly LEDs for status and diagnostics show status of input power, output power and alarm condition valuable troubleshooting aid to reduce system downtime.

Conditions	LED Status	
	ACOK LED	DCOK/FAIL LED
AC present / Output On	Green	Green
No AC power to PSU	OFF	OFF
Standby mode/main output off	Green	OFF
Power supply failure	Green	OFF

MECHANICAL SPECIFICATIONS

Weight

The LCM3000 series weight is 7.718lbs.(3.5kg) maximum.

ENVIRONMENTAL SPECIFICATIONS

EMC Immunity

The LCM3000 series are designed to meet the following EMC immunity specifications.

Table 6. Environmental Specifications	
Document	Description
EN55032	Conducted and radiated EMI limits
EN61000-3-2 harmonic	EMC limits for harmonic current emissions
EN61000-3-3	Voltage fluctuations
EN61000-4-2	Electromagnetic Compatibility (EMC) - Testing and measurement techniques - Electrostatic discharge immunity test. +/-15KV air, +/-8KV contact discharge, Criteria B
EN61000-4-3	Electromagnetic Compatibility (EMC) - Testing and measurement techniques, Radiated, radio-frequency, electromagnetic field immunity test. 10V/m, Criteria A
EN61000-4-4	Electromagnetic Compatibility (EMC) - Testing and measurement techniques, Electrical Fast Transient/Burst Immunity Test. 2KV for AC power port, Criteria B
EN61000-4-5	Electromagnetic Compatibility (EMC) - Testing and measurement techniques - 4KV common mode and 2KV differential mode for AC ports, Criteria B
EN61000-4-6	Conducted RFI, 10Vrms (Designed to meet at system level)
EN61000-4-8	Power Freq Magnetic, Level 3
EN61000-4-11	Electromagnetic Compatibility (EMC) - Testing and measurement techniques : Voltage Dips and Interruptions: 30% reduction for 500mS- Criteria B>95% reduction for 10mS, Criteria A, >95% reduction for 5000mS, Criteria C
EN55024: 1998	Information Technology Equipment - Immunity Characteristics, Limits and Method of Measurement

ENVIRONMENTAL SPECIFICATIONS

Safety Certifications

The LCM3000 series are intended for inclusion in other equipment and the installer must ensure that it is in compliance with all the requirements of the end application. This product is only for inclusion by professional installers within other equipment and must not be operated as a standard alone product.

Table 7. Safety Certifications for LCM3000 Series Power Supply System		
Standard	Agency	Description
UL/CSA62368-1 ANSI/ AAMI ES60601-1	UL + CSA	US and Canada Requirements
EN62368-1 and EN60601-1	TUV	European Requirements
IEC60950-1, IEC60601-1, IEC62368-1	CB Scheme	International Electrotechnical Commission
CE Mark		European Requirements
UKCA Mark		UK Requirements

ENVIRONMENTAL SPECIFICATIONS

EMI Emissions

The LCM3000 series has been designed to comply with the Class A limits of EMI requirements of EN55022 (FCC Part 15) and CISPR 32 (EN55032) for emissions and relevant sections of EN61000 (IEC 61000) for immunity. The unit is enclosed inside a metal box, tested at 3000W using resistive load with cooling fan.

Conducted Emissions

The applicable standard for conducted emissions is EN55032 (FCC Part 15). Conducted noise can appear as both differential mode and common mode noise currents. Differential mode noise is measured between the two input lines, with the major components occurring at the supply fundamental switching frequency and its harmonics. Common mode noise, a contributor to both radiated emissions and input conducted emissions, is measured between the input lines and system ground and can be broadband in nature.

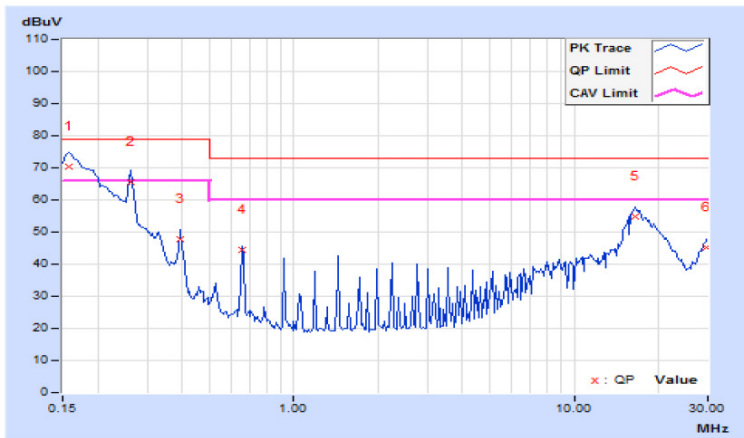

The LCM3000 series have internal EMI filters to ensure the converters' conducted EMI levels comply with EN55022 (FCC Part 15) Class A.

The EMI measurements are performed with resistive loads at maximum rated loading Sample of EN55022 Conducted EMI Measurement at 110Vac input.

Note: Red Line refers to Artesyn Quasi Peak margin, which is 6dB below the CISPR international limit. Pink Line refers to the Artesyn Average margin, which is 6dB below the CISPR international limit.

Conducted EMI emissions specifications of the LCM3000 series:

Parameter	Model	Symbol	Min	Typ	Max	Unit
FCC Part 15, class A	All	Margin	6	-	-	dB
CISPR 32 (EN55032), class A	All	Margin	6	-	-	dB

ENVIRONMENTAL SPECIFICATIONS

Radiated Emissions

Unlike conducted EMI, radiated EMI performance in a system environment may differ drastically from that in a stand-alone power supply. The shielding effect provided by the system enclosure may bring the EMI level from Class A to Class B. It is thus recommended that radiated EMI be evaluated in a system environment. The applicable standard is EN55022 Class A (FCC Part 15). Testing ac-dc convertors as a stand-alone component to the exact requirements of EN55022 can be difficult, because the standard calls for 1m leads to be attached to the input and outputs and aligned such as to maximize the disturbance. In such a set-up, it is possible to form a perfect dipole antenna that very few AC-DC convertors could pass. However, the standard also states that an attempt should be made to maximize the disturbance consistent with the typical application by varying the configuration of the test sample.

ENVIRONMENTAL SPECIFICATIONS

Operating Temperature

The LCM3000 series maximum output power (3000W) can be loaded up to an ambient temperature of +50 °C.

Only 50 % of the maximum output power can be loaded at ambient temperature of +70 °C. Linear derating to 50% nominal output power starts from +50 °C. The elapsed time between the application of input power and the attainment steady state values requires 5 minute warm up for -20 °C to -40 °C operation.

Output Power vs Operating Temperature

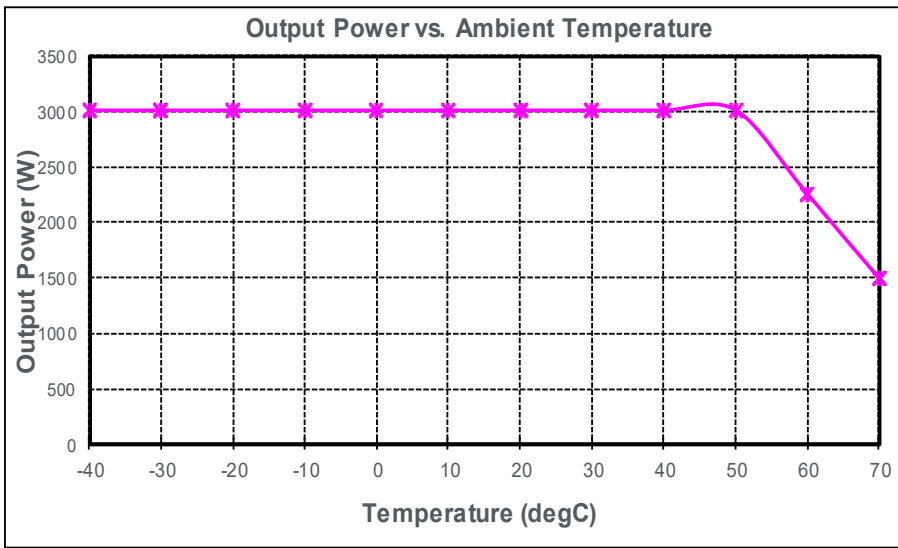

Forced Air Cooling

The LCM3000 series power supplies included internal cooling fans as part of the power supply assembly to provide forced air-cooling to maintain and control temperature of devices and ambient. The standard direction of airflow is from the end of the power supply.

The cooling fan is a variable speed fan. Fan will be smart based on internal temperature.

ENVIRONMENTAL SPECIFICATIONS

Storage and Shipping Temperature

The LCM3000 series can be stored or shipped at temperatures between -40 °C to +85 °C and relative humidity from 20% to 95% non-condensing.

Altitude

The LCM3000 series will operate within specifications at altitudes up to 16405 feet (5000 meters) above sea level. The power supply will not be damaged when stored at altitudes of up to 5000 meters above sea level.

Humidity

The LCM3000 series will operate within specifications when subjected to a relative humidity from 20% to 90% non-condensing. The LCM3000 series can be stored in a relative humidity from 10% to 95% non-condensing.

Vibration

The LCM3000 series will pass the following vibration specifications:

Non-Operating Random Vibration

Acceleration	1.0	gRMS	
Frequency Range	5 - 500	Hz	
Duration	30	Mins	
Direction	3 mutually perpendicular axis		
PSD Profile	FREQ (Hz)	SLOPE (db/oct)	PSD (g²/Hz)
	10	/	0.005
	20	/	0.01
	80	/	0.04
	350	/	0.04
	2000	/	0.007

Operating Random Vibration

Acceleration	1.0	gRMS	
Frequency Range	5 - 500	Hz	
Duration	30	Mins	
Direction	3 mutually perpendicular axis		
PSD Profile	FREQ (Hz)	SLOPE (db/oct)	PSD (g²/Hz)
	10	/	0.04
	350	/	0.04
	500	/	0.0198

ENVIRONMENTAL SPECIFICATIONS

Shock

The LCM3000 series power supply will pass the following shock specifications:

Non-Operating Half-Sine Shock

Acceleration	30	G
Duration	36	mSec
Pulse	trapezoidal	
Number of Shock	3 shock on each of 6 faces	

Operating Half-Sine Shock

Acceleration	40	G
Duration	6	mSec
Pulse	Half-Sine	
Number of Shock	3 shocks in each of 6 faces	

POWER AND CONTROL SIGNAL DESCRIPTIONS

AC Input Connector

This connector supplies the AC Mains to the LCM3000 series power supply.

- SK1 – Earth Ground
- SK1 – Line
- SK1 – Neutral

Output Connectors- SK3&SK4

These pins provide the main output for the LCM3000 series. The + Main Output (V_O) and the Main Output Return pins are the positive and negative rails, respectively, of the V_O main output of the LCM3000 series power supply. The Main Output (V_O) is electrically isolated from the power supply chassis.

- SK3 – +Main Output (V_O)
- SK4 – Main Output Return

Control Signals - SK2

The LCM3000 series SK2 contains 20 pins control signal header providing analogy control interface, standby power and i²C interface.

A0, A1, A2 - (Pin 6, Pin3, Pin1)

Please refer to “Communication Pins Descriptions” section.

-VPROG, +VPROG - (Pin2, Pin8)

Positive and return connection of external supply for Margin Programming. The Power supplies will have a “margin” pin which will accept a 1-6VDC signal referenced to a floating return that will program the output the entire adjustment range. Applying voltage greater than 6V may result to damage of PSU internal circuit.

-Vsense, +Vsense - (Pin 4, Pin10)

This remote sense circuit will be designed to compensate for a power path drop around the entire loop of 0.5 volt. These pins should be connected as close to the loading as possible, If left open, the power supply will regulate the voltage at its output terminals but the voltage level at the load may go lower than the guaranteed spec.

ISHARE - (Pin 5)

The main output will have active load sharing. The output will share within 10% at full load. All current sharing functions are implemented internal to the power supply by making use of the ISHARE signal. The system connects the ISHARE lines between the power supplies. The supplies must be able to load share with up to 8 power supplies in parallel.

SDA1, SCL1, GND - (Pin 7, Pin9, Pin17)

Please refer to “Communication Bus Descriptions” section.

5VSB, GND - (Pin11, Pin12, Pin13)

The LCM3000 series provides a regulated 5VSB output voltage to power critical circuitry that must remain active regardless of the on/off status of the power supply’s main output. The 5VSB voltage is available whenever a valid AC input voltage is applied to the unit.

POWER AND CONTROL SIGNAL DESCRIPTIONS

G_DCOK_C, G_DCOK_E - (Pin14, Pin16)

G_DCOK_C is a power good signal and could be driven “low” by the power supply to indicate that both the outputs are within the regulation limits of the power supply. When any output voltage falls below regulation limits or when AC power has been removed for a time sufficiently long so that power supply operation is no longer guaranteed, G_DCOK_C could be de-asserted to a high state. Connect 4.7K to 10K resistor on G_DCOK_C to PSU's 5VSB.

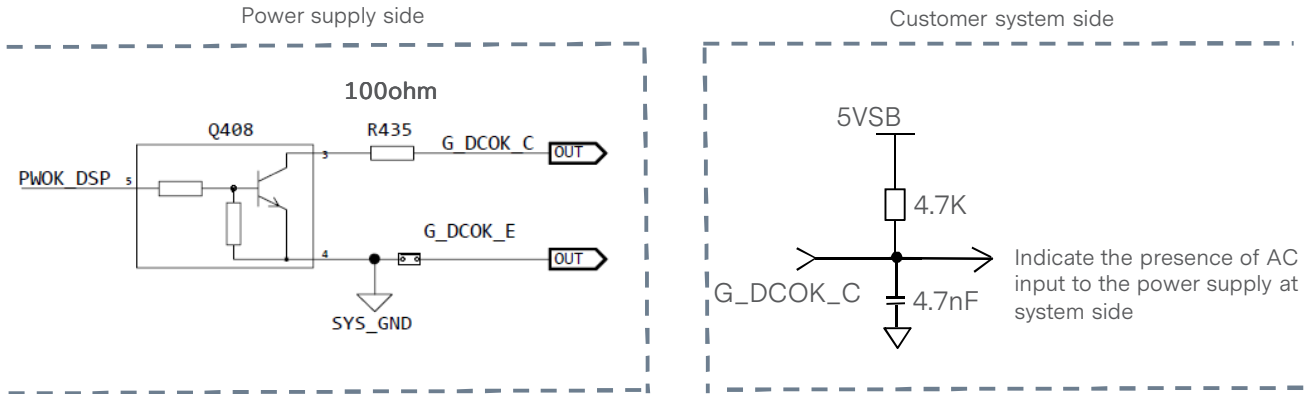

GPIOA6 - (Pin15)

EEPROM Write Protect Allows Read/Write operation when connected to Gnd. When GPIOA6 pin is connected to 3.3V, the write protection is enabled.

G_ACOK_C, G_ACOK_E - (Pin18, Pin20)

G-ACOK_C signal is used to indicate presence of AC input to the power supply. A logic “Low” level on this signal shall indicate AC input to the power supply is present. A Logic “High” on this signal shall indicate a loss of AC input to the power supply. Connect 4.7K to 10K resistor on G_ACOK_C to 5VSB.

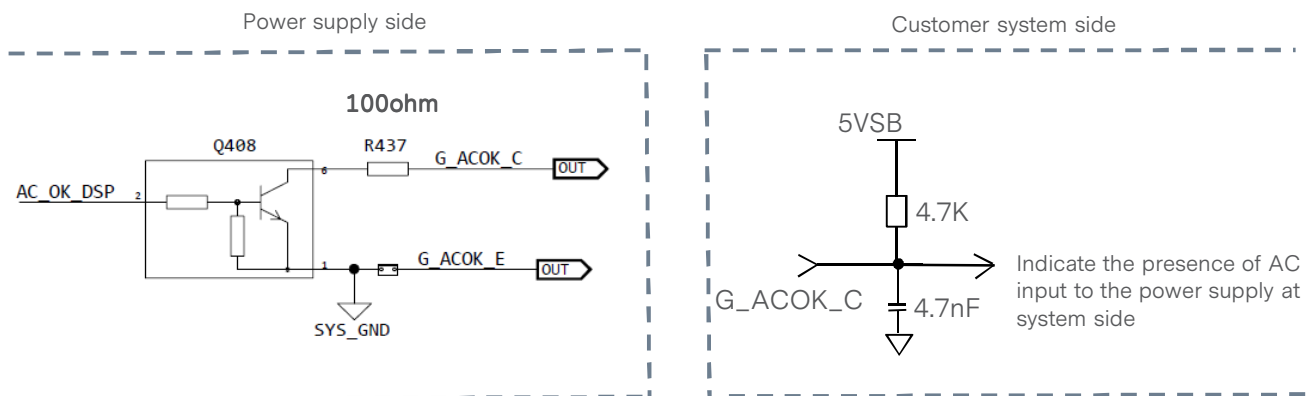

INH_EN - (Pin19)

0.0 - 0.5V contact closure main output is OFF. Left open will enable the Main output.

COMMUNICATION BUS DESCRIPTIONS

I²C Bus Signals

The LCM3000 series contains enhanced monitor and control functions implemented via the I²C bus. The LCM3000 series I²C functionality (PMBus™ and FRU data) can be accessed via the output connector control signals. The communication bus is powered either by the internal 3.3V supply or from an external power source connected to the Standby Output (ie: accessing an unpowered power supply as long as the Standby Output of another power supply connected in parallel is on).

If units are connected in parallel or in redundant mode, the Standby Outputs must be connected together in the system. Otherwise, the I²C bus will not work properly when a unit is inserted into the system without the AC source connected.

Note: PMBus™ functionality can be accessed only when the PSU is powered-up. Guaranteed communication I²C speed is 100KHz.

SDA1, SCL1 (I²C Data and Clock Signals) - (pin7, pin 9)

I²C serial data and clock bus - these pins are internally pulled up to internal 3.3V supply with a 4.7K ohm resistor. These pins must be pulled-up in the system by an 2.2K ohm resistor to the standby Output.

A0, A1, A2 (I²C Address BIT 0, BIT1, BIT2 Signals) - (pin6, pin3, pin1)

These three input pins are the address lines A0, A1 and A2 to indicate the slot position the power supply occupies in the power bay and define the power supply addresses for FRU data and PMBus™ data communication. This allows the system to assign different addresses for each power supply. During I²C communication between system and power supplies, the system will be the master and power supplies will be slave.

They are internally pulled up to internal 3.3V supply with a 2.7K ohm resistor.

I²C Bus Communication Interval

The interval between two consecutive I²C communications to the power supply should be at least 50ms to ensure proper monitoring functionality.

I²C Bus Signal Integrity

The noise on the I²C bus (SDA, SCL lines) due to the power supply will be less than 450mV peak-to-peak. This noise measurement should be made with an oscilloscope bandwidth limited to 100MHz. Measurements should be made at the power supply output connector with 2.2K ohm resistors pulled up to Standby Output and 20pf ceramic capacitors to standby Output Return.

The noise on the address lines A0 and A1 will be less than 100mV peak-to-peak. This noise measurement should be made at the power supply output connector.

COMMUNICATION BUS DESCRIPTIONS

I²C Bus Internal Implementation, Pull-ups and Bus Capacitances

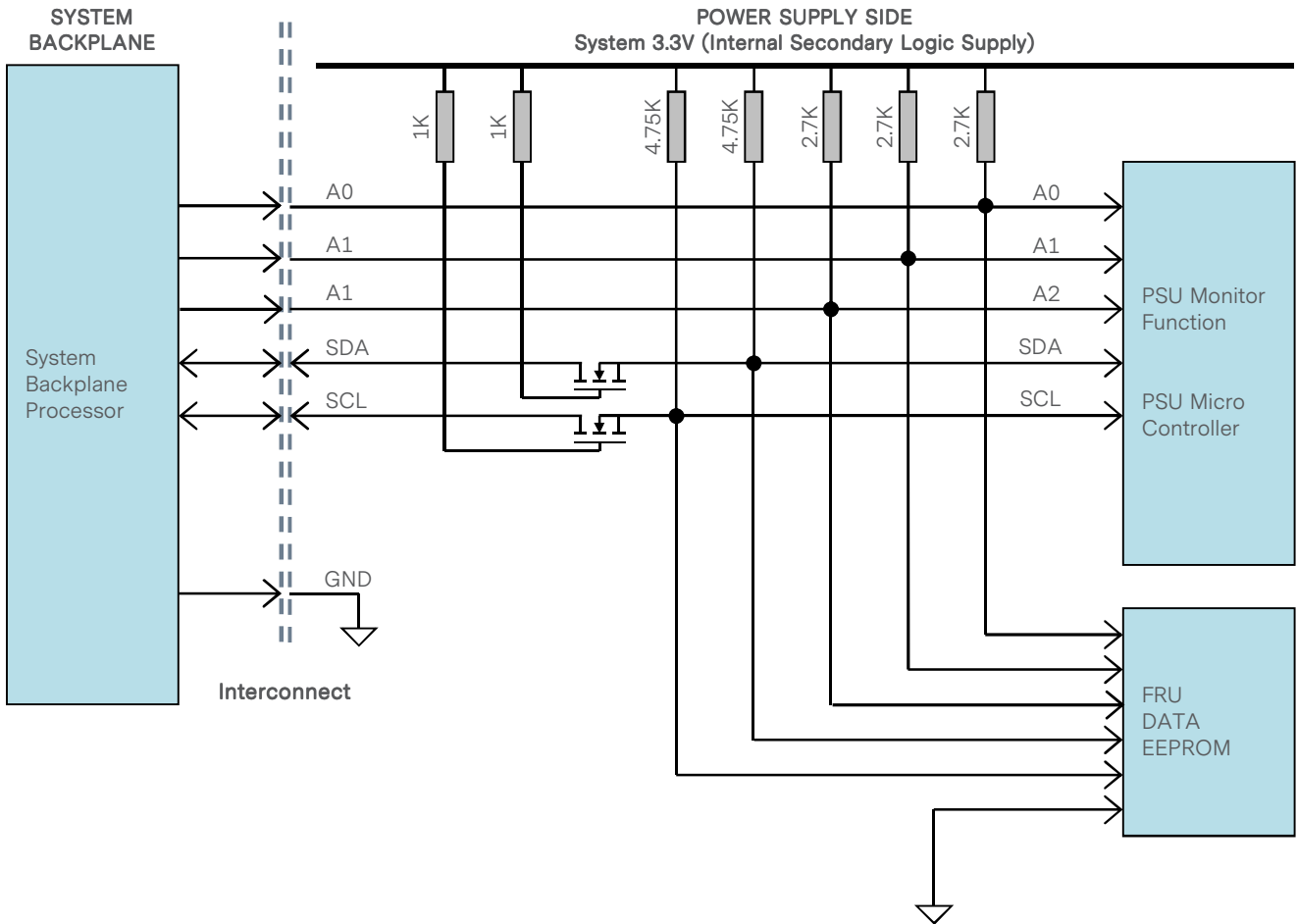

I²C Bus - Recommended external pull-ups

Electrical and interface specifications of I²C signals (referenced to standby output return pin, unless otherwise indicated):

Parameter	Condition	Symbol	Min	Type	Max	Unit
SDA, SCL Internal Pull-up Resistor		R_{int}	-	4.7	-	Kohm
SDA, SCL Internal Bus Capacitance		C_{int}	-	0	-	pF
Recommended External Pull-up Resistor	1 to 8 PSU	R_{ext}	-	2.2	-	Kohm

COMMUNICATION BUS DESCRIPTIONS

Device Addressing

Slave device address is configurable via address pins. Base address is 0xB0. FRU access requires another address and is configurable as well via the address pins. Base address is 0xA0. Below is the table of the possible addresses that can be used via the address pin configuration.

PSU Slot			PMBus Write Address	PMBus Read Address	FRU Write Address	FRU Read Address
A2	A1	A0				
1	1	1	0xBE	0xBF	0xAE	0xAF
1	1	0	0xBC	0xBD	0xAC	0xAD
1	0	1	0xBA	0xBB	0xAA	0xAB
1	0	0	0xB8	0xB9	0xA8	0xA9
0	1	1	0xB6	0xB7	0xA6	0xA7
0	1	0	0xB4	0xB5	0xA4	0xA5
0	0	1	0xB2	0xB3	0xA2	0xA3
0	0	0	0xB0	0xB1	0xA0	0xA1

Note: the address pins are in high state initially. Base I2C address is BE.

COMMUNICATION BUS DESCRIPTIONS

Logic Levels

LCM3000 series power supply I²C communication bus will respond to logic levels as per below:

Logic High: 3.3V nominal (Spec is 2.1V to 5.5V)**

Logic Low: 500mV nominal (Spec is 800mV max)**

**Note: Artesyn 73-769-001 I²C adapter was used.

Timings

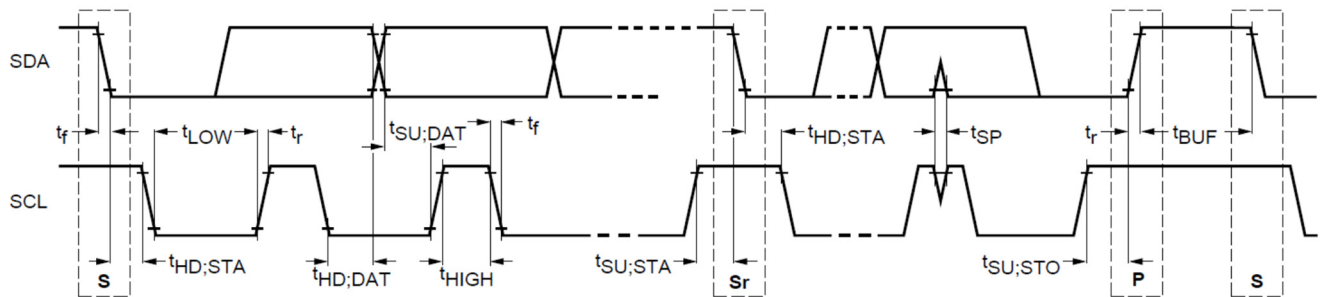

Parameter	Symbol	Standard-Mode Specs		Actual Measured		Unit
		Min	Max			
SCL clock frequency	f_{SCL}	10	100	99.62		KHz
Hold time (repeated) START condition	$t_{HD;STA}$	4.0	-	4.67		uS
LOW period of SCL clock	t_{LOW}	4.7	-	4.96		uS
HIGH period of SCL clock	t_{HIGH}	4.0	-	4.28		uS
Setup time for repeated START condition	$t_{SU;STA}$	4.7	-	4.70		uS
Data hold time	$t_{HD;DAT}$	0	3.45	0.20		uS
Data setup time	$t_{SU;DAT}$	250	-	4480		nS
Rise time	t_r	-	1000	SCL = 430	SCL = 368	nS
Fall time	t_f	-	300	SCL = 230	SCL = 70	nS
Setup time for STOP condition	$t_{SU;STO}$	4.0	-	4.93		uS
Bus free time between a STOP and START condition	t_{BUF}	4.7	-	9.51***		uS

***Note: Artesyn 73-769-001 I²C adapter (USB-to-I2C) and Universal PMBus™ GUI software was used.

COMMUNICATION BUS DESCRIPTIONS

I²C Synchronization

The LCM3000 series power supply might apply clock stretching. An addressed slave power supply may hold the clock line (SCL) low after receiving (or sending) a byte, indicating that it is not yet ready to process more data. The system master that is communicating with the power supply will attempt to raise the clock to transfer the next bit, but must verify that the clock line was actually raised. If the power supply is clock stretching, the clock line will still be low (because the connections are open-drain).

The maximum time-out condition for clock stretching for LCM3000 series is 100 milliseconds.

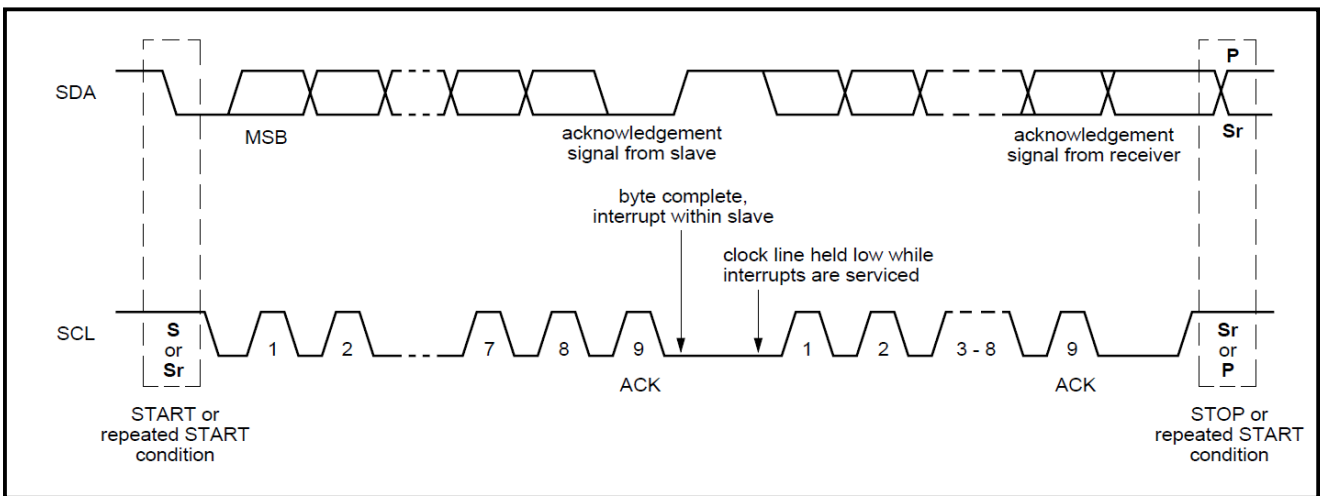

PMBus™ SPECIFICATIONS

The LCM3000 series is compliant with the industry standard PMBus™ protocol for monitoring and control of the power supply via the I²C interface port.

LCM3000 Series PMBus™ General Instructions

Equipment Setup

The following is typical I²C communication setup:

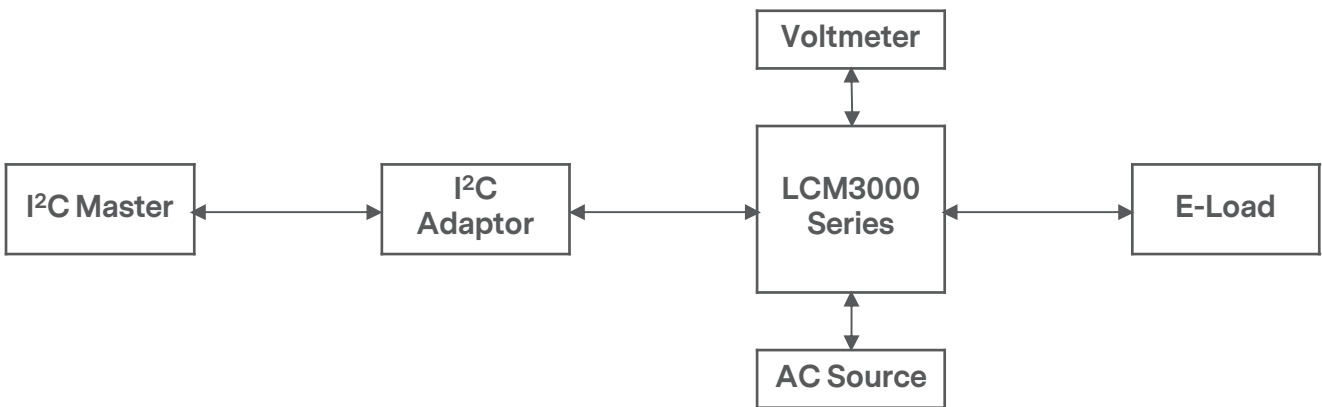

PMBus™ Writing Instructions

When writing to any PMBus™ R/W registers, ALWAYS do the following:

Disable Write Protect (command 10h) by writing any of the following accordingly:

Levels: 00h - Enable writing to all writeable commands

20h - Disables write except 10h, 01h, 00h, 02h and 21h commands

40h - Disables write except 10h, 01h, and 00h commands

80h - Disable write except 0x00h

To save changes on the USER PMBus™ Table:

Use send byte command: 15h STORE_USER_ALL

Wait for 5 seconds, turn-off the PSU, wait for another 5 seconds before turning it on.

PMBus™ SPECIFICATIONS

The LCM3000L-T Series Supported PMBus™ Command List:

Command Code	Command Name	Default Value	Access Type	Data Bytes	Data Format	Description
00h	PAGE	-	R	1	H	
01h	OPERATION	80	R/W	1	B	Used to turn the unit ON/OFF in conjunction with the input INH_EN pin. Write 40h to turn off PSU, 80h to turn on the PSU
02h	ON_OFF_CONFIG	1E	R	1	B	Configures the combination of INH_EN pin and serial communication commands needed to turn the unit ON/OFF
03h	CLEAR_FAULTS	-	S	0	N/A	
10h	WRITE_PROTECT	80	R/W	1	B	Used to Control Writing to the PMBus Device 80h - Disables write 40h - Disables write except 00h, 01h 00 - Enables write to all writeable commands
15h	STORE_USER_ALL	-	S	0	N/A	Copies the Operating memory table to the matching USER non-volatile memory
1Bh	SMBALERT_MASK	0	BR/W	1/1 (R) 2 (W)	B	BMC - no alert
20h	VOUT_MODE	18	R	1	B	Specifies the mode and parameters of Output Voltage related Data Formats
21h	VPROG	12	R/W	2	Linear	Digital Voltage Programming
35h	VIN_ON	90	R	2	Linear	
36h	VIN_OFF	85	R	2	Linear	
3Bh	FAN_COMMAND_1	0	R/W	2	Linear	Read and write Fan rotation.
40h	VOUT_OV_FAULT_LIMIT	16.199	R	2	Linear	Sets Output Over voltage threshold (16.199V)
41h	VOUT_OV_FAULT_RESPONSE	80	R	1	B	
42h	VOUT_OV_WARN_LIMIT	13.199	R	2	Linear	Sets Over-voltage Warning threshold (13.199V)
45h	VOUT_UV_FAULT_RESPONSE	78	R	1	B	
46h	IOUT_OC_FAULT_LIMIT	322.5	R	2	Linear	Sets the Over current threshold in Amps (322.5A)
47h	IOUT_OC_FAULT_RESPONSE	78	R	1	B	
4Fh	OT_FAULT_LIMIT	112	R	2	Linear	Secondary ambient temperature Fault threshold, in degree C (112degC)
50h	OT_FAULT_RESPONSE	C0	R	1	B	
51h	OT_WARN_LIMIT	108	R	2	Linear	Secondary ambient temperature warning threshold, in degree C. Operating limit (108degC)
6Ah	POUT_OP_WARN_LIMT	3452	R	2	Linear	

PMBus™ SPECIFICATIONS

The LCM3000L-T Series Supported PMBus™ Command List:

Command Code	Command Name	Default Value	Access Type	Data Bytes	Data Format	Description
78h	STATUS_BYTE	00	R	1	B	Returns the summary of critical faults
	b7 - BUSY					Not Supported
	b6 - OFF					Unit is OFF
	b5 - VOUT_OV_FAULT					Output over-voltage fault has occurred, will only be cleared when latching condition is removed
	b4 - IOUT_OC_FAULT					Not Supported
	b3 - VIN_UV_FAULT					Not Supported
	b2 - TEMPERATURE					A temperature fault or warning has occurred, will only be cleared when condition is removed
	b1 - CML					A communication, memory or logic fault has occurred
	b0 - NONE OF THE ABOVE					Not Supported
79h	STATUS_WORD	0000	R	2	B	Summary of units Fault and warning status
	b15 - VOUT					An output voltage fault or warning has occurred
	b14 - IOUT/POUT					An Output current or power fault or warning has occurred
	b13 - INPUT					Not Supported
	b12 - MFR_SPECIFIC					A manufacturer specific fault or warning has occurred
	b11 - POWER_GOOD#					The POWER_GOOD signal is de-asserted
	b10 - FANS					A fan or airflow fault or warning has occurred
	b9 - OTHERS					Not Supported
	b8 - UNKNOWN					Not Supported
	b7 - BUSY					Not Supported
	b6 - OFF					Unit is OFF
	b5 - VOUT_OV_FAULT					Output over-voltage fault has occurred, will only be cleared when latching condition is removed
	b4 - IOUT_OC_FAULT					Not Supported
	b3 - VIN_UV_FAULT					Not Supported
	b2 - TEMPERATURE					A temperature fault or warning has occurred, will only be cleared when condition is removed
b1 - CML					A communication, memory or logic fault has occurred	
	B0 - NONE_OF_THE_ABOVE					Not Supported

PMBus™ SPECIFICATIONS

The LCM3000L-T Series Supported PMBus™ Command List:

Command Code	Command Name	Default Value	Access Type	Data Bytes	Data Format	Description
7Ah	STATUS_VOUT	00	R/W	1	B	Output voltage related faults and warnings
	b7 - VOUT_OV_FAULT					VOUT Over-voltage Fault
	b6 - VOUT_OV_WARNING					VOUT Over-voltage Warning
	b5 - VOUT_UV_WARNING					Not Supported
	b4 - VOUT_UV_FAULT					VOUT Under-voltage Fault, asserts during short circuit condition and when output voltage reaches 35% of default value during constant current mode
	b3 - VOUT_MAX Warning					Not Supported
	b2 - TON_MAX_FAULT					TON_MAX_FAULT
	b1 - TOFF_MAX_WARNING					Not Supported
	b0 - VOUT Tracking Error					Not Supported
7Dh	STATUS_TEMPERATURE	00	R/W	1	B	Temperature related faults and warnings
	b7 - OT_FAULT					Over temperature Fault
	b6 - OT_WARNING					Over temperature Warning
	b5 - UT_WARNING					Not Supported
	b4 - UT_FAULT					Not Supported
	b3:0					reserved
7Eh	STATUS_CML	00	R/W	1	B	Communications, Logic and Memory
80h	STATUS_MFR_SPECIFIC	00	R/W	1	B	Manufacturer Status codes
81h	STATUS_FANS_1_2	00	R/W	1	B	
8Bh	READ_VOUT	-	R	2	Linear	Returns the actual, measured voltage in Volts
8Ch	READ_IOUT	-	R	2	Linear	Returns the output current in amperes
8Dh	READ_TEMPERATURE_1	-	R	2	Linear	Pri Hotspot (RT103, TEMP FWHL)
8Eh	READ_TEMPERATURE_2	-	R	2	Linear	Sec Hotspot (RT101, TEMP ORING)
8Fh	READ_TEMPERATURE_3	-	R	2	Linear	TEMP Ambient (Secondary control board)
90h	READ_FAN_SPEED_1	-	R	2	Linear	
91h	READ_FAN_SPEED_2	-	R	2	Linear	
96h	READ_POUT	-	R	2	Linear	Returns the output power, in Watts
98h	PMBUS_REVISION	22	RB	1	Linear	
99h	MFR_ID	Artesyn	BR	-	ASCII	41,52,54,45,53,59,4E
9Ah	MFR_MODEL	LCM3000L-T	BR	-	ASCII	
9Bh	MFR_REVISION	-	BR	-	ASCII	
9Ch	MFR_LOCATION	-	BR	-	ASCII	
9Dh	MFR_DATE	-	BR	-	ASCII	
9Eh	MFR_SERIAL	-	BR	-	ASCII	

PMBus™ SPECIFICATIONS

The LCM3000L-T Series Supported PMBus™ Command List:

Command Code	Command Name	Default Value	Access Type	Data Bytes	Data Format	Description
A0h	MFR_VIN_MIN	90	R	2	Linear	Minimum Input Voltage (90Vac)
A1h	MFR_VIN_MAX	264	R	2	Linear	Maximum Input Voltage (264Vac)
A2h	MFR_IIN_MAX	20	R	2	Linear	Maximum Input Current (20A)
A3h	MFR_PIN_MAX	3300	R	2	Linear	3300W
A4h	MFR_VOUT_MIN	9	R	2	Linear	
A5h	MFR_VOUT_MAX	15	R	2	Linear	
A6h	MFR_IOUT_MAX	250	R	2	Linear	Maximum Output Current
A7h	MFR_POUT_MAX	3000	R	2	Linear	Maximum Output Power
A8h	MFR_TAMBIENT_MAX	70	R	2	Linear	Maximum Operating Ambient Temperature (Secondary Ambient) (70 degC)
A9h	MFR_TAMBIENT_MIN	-40	R	2	Linear	Minimum Operating Ambient Temperature (Secondary Ambient) (-40 degC)
AAh	MFR_EFFICIENCY_LL	180,3000,85	BR	14	Linear	
ABh	MFR_EFFICIENCY_HL	230,3000,88	BR	14	Linear	
B0h	USER_DATA_B0	-	BR/W	-	Hex	
D6h	IPROG	FFFE	R/W	2	Hex	Iprog Value
D9h	INH_EN LOGIC	00	R/W	1	B	Inhibit logic (0 Active Low, 1 Active High)
DAh	VPROG_SELECT	0	R/W	1	B	Digital Vprog Select (0:Analog 1: Digital)
E1h	FW_SEC_VERSION	-	BR	8	ASCII	
E2h	CONFIG_UNLOCK_CODE	00,00,00,00,00	BR/W	4	ASCII	
F0h	PMBUS_IMP_SPEC_REVISION	-	BR	2	ASCII	
F1h	ISP_UNLOCK_CODE	00,00,00,00,00	BR/W	2	ASCII	
F2h	ISP_CTRL_CMD	-	R/W	1	B	
F3h	ISP_STATUS_BYTE	-	R	1	D	
F5h	ISP_FLASH_DATA	-	BR	16	H	

PMBus™ SPECIFICATIONS

The LCM30008-T Series Supported PMBus™ Command List:

Command Code	Command Name	Default Value	Access Type	Data Bytes	Data Format	Description
00h	PAGE	-	R	1	H	
01h	OPERATION	80	R/W	1	B	Used to turn the unit ON/OFF in conjunction with the input INH_EN pin. Write 40h to turn off PSU, 80h to turn on the PSU
02h	ON_OFF_CONFIG	1E	R	1	B	Configures the combination of INH_EN pin and serial communication commands needed to turn the unit ON/OFF
03h	CLEAR_FAULTS	-	S	0	N/A	
10h	WRITE_PROTECT	80	R/W	1	B	Used to Control Writing to the PMBus Device 80h - Disables write 40h - Disables write except 00h, 01h 00 - Enables write to all writeable commands
15h	STORE_USER_ALL	-	S	0	N/A	Copies the Operating memory table to the matching USER non-volatile memory
1Bh	SMBALERT_MASK	0	BR/W	1/1 (R) 2 (W)	B	BMC - no alert
20h	VOUT_MODE	18	R	1	B	Specifies the mode and parameters of Output Voltage related Data Formats
35h	VIN_ON	90	R	2	Linear	
36h	VIN_OFF	85	R	2	Linear	
3Bh	FAN_COMMAND_1	0	R/W	2	Linear	Read and write Fan rotation
40h	VOUT_OV_FAULT_LIMIT	24.297	R	2	Linear	Sets Output Over voltage threshold (24.297V)
41h	VOUT_OV_FAULT_RESPONSE	80	R	1	B	
42h	VOUT_OV_WARN_LIMIT	19.789	R	2	Linear	Sets Over-voltage Warning threshold(19.789V)
45h	VOUT_UV_FAULT_RESPONSE	78	R	1	B	
46h	IOUT_OC_FAULT_LIMIT	215.5	R	2	Linear	Sets the Over current threshold in Amps (215.5A)
47h	IOUT_OC_FAULT_RESPONSE	78	R	1	B	
4Fh	OT_FAULT_LIMIT	112	R	2	Linear	Secondary ambient temperature Fault threshold, in degree C (112degC)
50h	OT_FAULT_RESPONSE	C0	R	1	B	
51h	OT_WARN_LIMIT	108	R	2	Linear	Secondary ambient temperature warning threshold, in degree C. Operating limit (108degC)
6Ah	POUT_OP_WARN_LIMT	3452	R	2	Linear	

PMBus™ SPECIFICATIONS

The LCM30008-T Series Supported PMBus™ Command List:

Command Code	Command Name	Default Value	Access Type	Data Bytes	Data Format	Description
78h	STATUS_BYTE	00	R	1	B	Returns the summary of critical faults
	b7 - BUSY					Not Supported
	b6 - OFF					Unit is OFF
	b5 - VOUT_OV_FAULT					Output over-voltage fault has occurred, will only be cleared when latching condition is removed
	b4 - IOUT_OC_FAULT					Not Supported
	b3 - VIN_UV_FAULT					Not Supported
	b2 - TEMPERATURE					A temperature fault or warning has occurred, will only be cleared when condition is removed
	b1 - CML					A communication, memory or logic fault has occurred
	b0 - NONE OF THE ABOVE					Not Supported
79h	STATUS_WORD	0000	R	2	B	Summary of units Fault and warning status
	b15 - VOUT					An output voltage fault or warning has occurred
	b14 - IOUT/POUT					An Output current or power fault or warning has occurred
	b13 - INPUT					Not Supported
	b12 - MFR_SPECIFIC					A manufacturer specific fault or warning has occurred
	b11 - POWER_GOOD#					The POWER_GOOD signal is de-asserted
	b10 - FANS					A fan or airflow fault or warning has occurred
	b9 - OTHERS					Not Supported
	b8 - UNKNOWN					Not Supported
	b7 - BUSY					Not Supported
	b6 - OFF					Unit is OFF
	b5 - VOUT_OV_FAULT					Output over-voltage fault has occurred, will only be cleared when latching condition is removed
	b4 - IOUT_OC_FAULT					Not Supported
	b3 - VIN_UV_FAULT					Not Supported
	b2 - TEMPERATURE					A temperature fault or warning has occurred, will only be cleared when condition is removed
	b1 - CML					A communication, memory or logic fault has occurred
	B0 - NONE_OF_THE_ABOVE					Not Supported

PMBus™ SPECIFICATIONS

The LCM30008-T Series Supported PMBus™ Command List:

Command Code	Command Name	Default Value	Access Type	Data Bytes	Data Format	Description
7Ah	STATUS_VOUT	00	R/W	1	B	Output voltage related faults and warnings
	b7 - VOUT_OV_FAULT					VOUT Over-voltage Fault
	b6 - VOUT_OV_WARNING					VOUT Over-voltage Warning
	b5 - VOUT_UV_WARNING					Not Supported
	b4 - VOUT_UV_FAULT					VOUT Under-voltage Fault, asserts during short circuit condition and when output voltage reaches 35% of default value during constant current mode
	b3 - VOUT_MAX Warning					Not Supported
	b2 - TON_MAX_FAULT					TON_MAX_FAULT
	b1 - TOFF_MAX_WARNING					Not Supported
b0 - VOUT Tracking Error					Not Supported	
7Dh	STATUS_TEMPERATURE	00	R/W	1	B	Temperature related faults and warnings
	b7 - OT_FAULT					Over temperature Fault
	b6 - OT_WARNING					Over temperature Warning
	b5 - UT_WARNING					Not Supported
	b4 - UT_FAULT					Not Supported
b3:0					reserved	
7Eh	STATUS_CML	00	R/W	1	B	Communications, Logic and Memory
80h	STATUS_MFR_SPECIFIC	00	R/W	1	B	Manufacturer Status codes
81h	STATUS_FANS_1_2	00	R/W	1	B	
8Bh	READ_VOUT	-	R	2	Linear	Returns the actual, measured voltage in Volts
8Ch	READ_IOUT	-	R	2	Linear	Returns the output current in amperes
8Dh	READ_TEMPERATURE_1	-	R	2	Linear	Pri Hotspot
8Eh	READ_TEMPERATURE_2	-	R	2	Linear	Sec Hotspot
8Fh	READ_TEMPERATURE_3	-	R	2	Linear	Secondary Ambient
90h	READ_FAN_SPEED_1	-	R	2	Linear	
91h	READ_FAN_SPEED_2	-	R	2	Linear	
96h	READ_POUT	-	R	2	Linear	Returns the output power, in Watts
98h	PMBUS_REVISION	22	RB	1	Linear	
99h	MFR_ID	Artesyn	BR	-	ASCII	41,52,54,45,53,59,4E
9Ah	MFR_MODEL	LCM30008-T	BR	-	ASCII	
9Bh	MFR_REVISION	-	BR	-	ASCII	
9Ch	MFR_LOCATION	-	BR	-	ASCII	

PMBus™ SPECIFICATIONS

The LCM30008-T Series Supported PMBus™ Command List:

Command Code	Command Name	Default Value	Access Type	Data Bytes	Data Format	Description
9Dh	MFR_DATE	-	BR	-	ASCII	
9Eh	MFR_SERIAL	-	BR	-	ASCII	
A0h	MFR_VIN_MIN	90	R	2	Linear	Minimum Input Voltage (90Vac)
A1h	MFR_VIN_MAX	264	R	2	Linear	Maximum Input Voltage (264Vac)
A2h	MFR_IIN_MAX	20	R	2	Linear	Maximum Input Current (20A)
A3h	MFR_PIN_MAX	3300	R	2	Linear	3300W
A4h	MFR_VOUT_MIN	13.5	R	2	Linear	
A5h	MFR_VOUT_MAX	22.5	R	2	Linear	
A6h	MFR_IOUT_MAX	166.75	R	2	Linear	Maximum Output Current
A7h	MFR_POUT_MAX	3000	R	2	Linear	Maximum Output Power
A8h	MFR_TAMBIENT_MAX	70	R	2	Linear	Maximum Operating Ambient Temperature (Secondary Ambient) (70 degC)
A9h	MFR_TAMBIENT_MIN	-40	R	2	Linear	Minimum Operating Ambient Temperature (Secondary Ambient) (-40 degC)
AAh	MFR_EFFICIENCY_LL	180,3000,85	BR	14	Linear	
ABh	MFR_EFFICIENCY_HL	230,3000,88	BR	14	Linear	
B0h	USER_DATA_B0	-	BR/W	-	Hex	
D6h	IPROG	FFFE	R/W	2	Hex	Iprog Value
D9h	INH_EN LOGIC	00	R/W	1	B	Inhibit logic (0 Active Low, 1 Active High)
E1h	FW_SEC_VERSION	-	BR	8	ASCII	
E2h	CONFIG_UNLOCK_CODE	00,00,00,00,00	BR/W	4	ASCII	
F0h	PMBUS_IMP_SPEC_REVISION	-	BR	2	ASCII	
F1h	ISP_UNLOCK_CODE	00,00,00,00,00	BR/W	2	ASCII	
F2h	ISP_CTRL_CMD	-	R/W	1	B	
F3h	ISP_STATUS_BYTE	-	R	1	D	
F5h	ISP_FLASH_DATA	-	BR	16	H	

PMBus™ SPECIFICATIONS

The LCM3000Q-T Series Supported PMBus™ Command List:

Command Code	Command Name	Default Value	Access Type	Data Bytes	Data Format	Description
00h	PAGE	-	R	1	H	
01h	OPERATION	80	R/W	1	B	Used to turn the unit ON/OFF in conjunction with the input INH_EN pin. Write 40h to turn off PSU, 80h to turn on the PSU
02h	ON_OFF_CONFIG	1E	R	1	B	Configures the combination of INH_EN pin and serial communication commands needed to turn the unit ON/OFF
03h	CLEAR_FAULTS	-	S	0	N/A	
10h	WRITE_PROTECT	80	R/W	1	B	Used to Control Writing to the PMBus Device 80h - Disables write 40h - Disables write except 00h, 01h 00 - Enables write to all writeable commands
15h	STORE_USER_ALL	-	S	0	N/A	Copies the Operating memory table to the matching USER non-volatile memory
1Bh	SMBALERT_MASK	0	BR/W	1/1 (R) 2 (W)	B	BMC - no alert
20h	VOUT_MODE	18	R	1	B	Specifies the mode and parameters of Output Voltage related Data Formats
21h	VPROG	24	R/W	2	Linear	Digital Voltage Programming
35h	VIN_ON	90	R	2	Linear	
36h	VIN_OFF	85	R	2	Linear	
3Bh	FAN_COMMAND_1	0	R/W	2	Linear	Read and write Fan rotation
40h	VOUT_OV_FAULT_LIMIT	32.398	R	2	Linear	Sets Output Over voltage threshold (32.398V)
41h	VOUT_OV_FAULT_RESPONSE	80	R	1	B	
42h	VOUT_OV_WARN_LIMIT	26.398	R	2	Linear	Sets Over-voltage Warning threshold(26.398V)
45h	VOUT_UV_FAULT_RESPONSE	78	R	1	B	
46h	IOUT_OC_FAULT_LIMIT	162.5	R	2	Linear	Sets the Over current threshold in Amps (162.5A)
47h	IOUT_OC_FAULT_RESPONSE	78	R	1	B	
4Fh	OT_FAULT_LIMIT	112	R	2	Linear	Secondary ambient temperature Fault threshold, in degree C (112degC)
50h	OT_FAULT_RESPONSE	C0	R	1	B	
51h	OT_WARN_LIMIT	108	R	2	Linear	Secondary ambient temperature warning threshold, in degree C. Operating limit (108degC)
6Ah	POUT_OP_WARN_LIMT	3452	R	2	Linear	

PMBus™ SPECIFICATIONS

The LCM3000Q-T Series Supported PMBus™ Command List:

Command Code	Command Name	Default Value	Access Type	Data Bytes	Data Format	Description
78h	STATUS_BYTE	00	R	1	B	Returns the summary of critical faults
	b7 - BUSY					Not Supported
	b6 - OFF					Unit is OFF
	b5 - VOUT_OV_FAULT					Output over-voltage fault has occurred, will only be cleared when latching condition is removed
	b4 - IOUT_OC_FAULT					Not Supported
	b3 - VIN_UV_FAULT					Not Supported
	b2 - TEMPERATURE					A temperature fault or warning has occurred, will only be cleared when condition is removed
	b1 - CML					A communication, memory or logic fault has occurred
	b0 - NONE OF THE ABOVE					Not Supported
79h	STATUS_WORD	0000	R	2	B	Summary of units Fault and warning status
	b15 - VOUT					An output voltage fault or warning has occurred
	b14 - IOUT/POUT					An Output current or power fault or warning has occurred
	b13 - INPUT					Not Supported
	b12 - MFR_SPECIFIC					A manufacturer specific fault or warning has occurred
	b11 - POWER_GOOD#					The POWER_GOOD signal is de-asserted
	b10 - FANS					A fan or airflow fault or warning has occurred
	b9 - OTHERS					Not Supported
	b8 - UNKNOWN					Not Supported
	b7 - BUSY					Not Supported
	b6 - OFF					Unit is OFF
	b5 - VOUT_OV_FAULT					Output over-voltage fault has occurred, will only be cleared when latching condition is removed
	b4 - IOUT_OC_FAULT					Not Supported
	b3 - VIN_UV_FAULT					Not Supported
	b2 - TEMPERATURE					A temperature fault or warning has occurred, will only be cleared when condition is removed
	b1 - CML					A communication, memory or logic fault has occurred
	B0 - NONE_OF_THE_ABOVE					Not Supported

PMBus™ SPECIFICATIONS

The LCM3000Q-T Series Supported PMBus™ Command List:

Command Code	Command Name	Default Value	Access Type	Data Bytes	Data Format	Description
7Ah	STATUS_VOUT	00	R/W	1	B	Output voltage related faults and warnings
	b7 - VOUT_OV_FAULT					VOUT Over-voltage Fault
	b6 - VOUT_OV_WARNING					VOUT Over-voltage Warning
	b5 - VOUT_UV_WARNING					Not Supported
	b4 - VOUT_UV_FAULT					VOUT Under-voltage Fault, asserts during short circuit condition and when output voltage reaches 35% of default value during constant current mode
	b3 - VOUT_MAX Warning					Not Supported
	b2 - TON_MAX_FAULT					TON_MAX_FAULT
	b1 - TOFF_MAX_WARNING					Not Supported
	b0 - VOUT Tracking Error					Not Supported
7Dh	STATUS_TEMPERATURE	00	R/W	1	B	Temperature related faults and warnings
	b7 - OT_FAULT					Over temperature Fault
	b6 - OT_WARNING					Over temperature Warning
	b5 - UT_WARNING					Not Supported
	b4 - UT_FAULT					Not Supported
	b3:0					reserved
7Eh	STATUS_CML	00	R/W	1	B	Communications, Logic and Memory
80h	STATUS_MFR_SPECIFIC	00	R/W	1	B	Manufacturer Status codes
81h	STATUS_FANS_1_2	00	R/W	1	B	
8Bh	READ_VOUT	-	R	2	Linear	Returns the actual, measured voltage in Volts
8Ch	READ_IOUT	-	R	2	Linear	Returns the output current in amperes
8Dh	READ_TEMPERATURE_1	-	R	2	Linear	Pri Hotspot
8Eh	READ_TEMPERATURE_2	-	R	2	Linear	Sec Hotspot
8Fh	READ_TEMPERATURE_3	-	R	2	Linear	Secondary Ambient
90h	READ_FAN_SPEED_1	-	R	2	Linear	
91h	READ_FAN_SPEED_2	-	R	2	Linear	
96h	READ_POUT	-	R	2	Linear	Returns the output power, in Watts
98h	PMBUS_REVISION	22	RB	1	Linear	
99h	MFR_ID	Artesyn	BR	-	ASCII	41,52,54,45,53,59,4E
9Ah	MFR_MODEL	LCM3000Q-T	BR	-	ASCII	
9Bh	MFR_REVISION	-	BR	-	ASCII	
9Ch	MFR_LOCATION	-	BR	-	ASCII	

PMBus™ SPECIFICATIONS

The LCM3000Q-T Series Supported PMBus™ Command List:

Command Code	Command Name	Default Value	Access Type	Data Bytes	Data Format	Description
9Dh	MFR_DATE	-	BR	-	ASCII	
9Eh	MFR_SERIAL	-	BR	-	ASCII	
A0h	MFR_VIN_MIN	90	R	2	Linear	Minimum Input Voltage (90Vac)
A1h	MFR_VIN_MAX	264	R	2	Linear	Maximum Input Voltage (264Vac)
A2h	MFR_IIN_MAX	20	R	2	Linear	Maximum Input Current (20A)
A3h	MFR_PIN_MAX	3300	R	2	Linear	3300W
A4h	MFR_VOUT_MIN	18	R	2	Linear	
A5h	MFR_VOUT_MAX	30	R	2	Linear	
A6h	MFR_IOUT_MAX	125	R	2	Linear	Maximum Output Current
A7h	MFR_POUT_MAX	3000	R	2	Linear	Maximum Output Power
A8h	MFR_TAMBIENT_MAX	70	R	2	Linear	Maximum Operating Ambient Temperature (Secondary Ambient) (70 degC)
A9h	MFR_TAMBIENT_MIN	-40	R	2	Linear	Minimum Operating Ambient Temperature (Secondary Ambient) (-40 degC)
AAh	MFR_EFFICIENCY_LL	180,3000,85	BR	14	Linear	
ABh	MFR_EFFICIENCY_HL	230,3000,88	BR	14	Linear	
B0h	USER_DATA_B0	-	BR/W	-	Hex	
D9h	INH_EN LOGIC	00	R/W	1	B	Inhibit logic (0 Active Low, 1 Active High)
DAh	VPROG_SELECT	0	R/W	1	B	Digital Vprog Select (0:Analog 1: Digital)
E1h	FW_SEC_VERSION	-	BR	8	ASCII	
E2h	CONFIG_UNLOCK_CODE	00,00,00,00,00	BR/W	4	ASCII	
F0h	PMBUS_IMP_SPEC_REVISION	-	BR	2	ASCII	
F1h	ISP_UNLOCK_CODE	00,00,00,00,00	BR/W	2	ASCII	
F2h	ISP_CTRL_CMD	-	R/W	1	B	
F3h	ISP_STATUS_BYTE	-	R	1	D	
F5h	ISP_FLASH_DATA	-	BR	16	H	
8Dh	READ_TEMPERATURE_1	-	R	2	Linear	Pri Hotspot
8Eh	READ_TEMPERATURE_2	-	R	2	Linear	Sec Hotspot

PMBus™ SPECIFICATIONS

The LCM3000U-T Series Supported PMBus™ Command List:

Command Code	Command Name	Default Value	Access Type	Data Bytes	Data Format	Description
00h	PAGE	-	R	1	H	
01h	OPERATION	80	R/W	1	B	Used to turn the unit ON/OFF in conjunction with the input INH_EN pin. Write 40h to turn off PSU, 80h to turn on the PSU
02h	ON_OFF_CONFIG	1E	R	1	B	Configures the combination of INH_EN pin and serial communication commands needed to turn the unit ON/OFF
03h	CLEAR_FAULTS	-	S	0	N/A	
10h	WRITE_PROTECT	80	R/W	1	B	Used to Control Writing to the PMBus Device 80h - Disables write 40h - Disables write except 00h, 01h 00 - Enables write to all writeable commands
15h	STORE_USER_ALL	-	S	0	N/A	Copies the Operating memory table to the matching USER non-volatile memory
1Bh	SMBALERT_MASK	0	BR/W	1/1 (R) 2 (W)	B	BMC - no alert
20h	VOUT_MODE	18	R	1	B	Specifies the mode and parameters of Output Voltage related Data Formats
35h	VIN_ON	90	R	2	Linear	
36h	VIN_OFF	85	R	2	Linear	
3Bh	FAN_COMMAND_1	0	R/W	2	Linear	Read and write Fan rotation
40h	VOUT_OV_FAULT_LIMIT	48.598	R	2	Linear	Sets Output Over voltage threshold (48.598V)
41h	VOUT_OV_FAULT_RESPONSE	80	R	1	B	
42h	VOUT_OV_WARN_LIMIT	39.59	R	2	Linear	Sets Over-voltage Warning threshold(39.59V)
45h	VOUT_UV_FAULT_RESPONSE	78	R	1	B	
46h	IOUT_OC_FAULT_LIMIT	107.625	R	2	Linear	Sets the Over current threshold in Amps (107.625A)
47h	IOUT_OC_FAULT_RESPONSE	78	R	1	B	
4Fh	OT_FAULT_LIMIT	112	R	2	Linear	Secondary ambient temperature Fault threshold, in degree C (112degC)
50h	OT_FAULT_RESPONSE	C0	R	1	B	
51h	OT_WARN_LIMIT	108	R	2	Linear	Secondary ambient temperature warning threshold, in degree C. Operating limit (108degC)
6Ah	POUT_OP_WARN_LIMT	3452	R	2	Linear	

PMBus™ SPECIFICATIONS

The LCM3000U-T Series Supported PMBus™ Command List:

Command Code	Command Name	Default Value	Access Type	Data Bytes	Data Format	Description
78h	STATUS_BYTE	00	R	1	B	Returns the summary of critical faults
	b7 - BUSY					Not Supported
	b6 - OFF					Unit is OFF
	b5 - VOUT_OV_FAULT					Output over-voltage fault has occurred, will only be cleared when latching condition is removed
	b4 - IOUT_OC_FAULT					Output over-current fault has occurred, for LCM3000U-T and LCM3000U-T-401 only
	b3 - VIN_UV_FAULT					Not Supported
	b2 - TEMPERATURE					A temperature fault or warning has occurred, will only be cleared when condition is removed
	b1 - CML					A communication, memory or logic fault has occurred
79h	b0 - NONE OF THE ABOVE					Not Supported
	STATUS_WORD	0000	R	2	B	Summary of units Fault and warning status.
	b15 - VOUT					An output voltage fault or warning has occurred
	b14 - IOUT/POUT					An Output current or power fault or warning has occurred.
	b13 - INPUT					Not Supported
	b12 - MFR_SPECIFIC					A manufacturer specific fault or warning has occurred.
	b11 - POWER_GOOD#					The POWER_GOOD signal is de-asserted
	b10 - FANS					A fan or airflow fault or warning has occurred.
	b9 - OTHERS					Not Supported
	b8 - UNKNOWN					Not Supported
	b7 - BUSY					Not Supported
b6 - OFF					Unit is OFF	

PMBus™ SPECIFICATIONS

The LCM3000U-T Series Supported PMBus™ Command List:

Command Code	Command Name	Default Value	Access Type	Data Bytes	Data Format	Description
79h	b5 - VOUT_OV_FAULT					Output over-voltage fault has occurred
	b4 - IOUT_OC_FAULT					Output over-current fault has occurred, for LCM3000U-T and LCM3000U-T-401 only
	b3 - VIN_UV_FAULT					Not Supported
	b2 - TEMPERATURE					A temperature fault or warning has occurred
	b1 - CML					A communication, memory or logic fault has occurred.
	b0 - NONE_OF_THE_ABOVE					Not Supported
7Ah	STATUS_VOUT	00	R/W	1	B	Output voltage related faults and warnings
	b7 - VOUT_OV_FAULT					VOUT Over-voltage Fault
	b6 - VOUT_OV_WARNING					VOUT Over-voltage Warning
	b5 - VOUT_UV_WARNING					Not Supported
	b4 - VOUT_UV_FAULT					VOUT Under-voltage Fault
	b3 - VOUT_MAX Warning					Not Supported
	b2 - TON_MAX_FAULT					TON_MAX_FAULT
	b1 - TOFF_MAX_WARNING					Not Supported
b0 - VOUT Tracking Error					Not Supported	
7Bh	STATUS_IOUT	00	R/W	1	B	Output Current related faults and warnings
	b7 - IOUT_OC_FAULT					IOUT Over current Fault, for LCM3000U-T and LCM3000U-T-401 only
	b6 - IOUT_OC_LV_FAULT					Not Supported
	b5 - IOUT_OC_WARNING					Not Supported
	b4 - IOUT_UC_FAULT					Not Supported
	b3 - Current Share Fault					Not Supported
	b2 - In Power Limiting Mode					Not Supported
	b1 - POUT_OP_FAULT					Not Supported
b0 - POUT_OP_WARNING					Not Supported	
7Dh	STATUS_TEMPERATURE	00	R/W	1	B	Temperature related faults and warnings
	b7 - OT_FAULT					Over temperature Fault
	b6 - OT_WARNING					Over temperature Warning
	b5 - UT_WARNING					Not Supported
	b4 - UT_FAULT					Not Supported
b3:0					reserved	
7Eh	STATUS_CML	00	R/W	1	B	Communications, Logic and Memory
80h	STATUS_MFR_SPECIFIC	00	R/W	1	B	Manufacturer Status codes
81h	STATUS_FANS_1_2	00	R/W	1	B	
8Bh	READ_VOUT	-	R	2	Linear	Returns the actual, measured voltage in Volts
8Ch	READ_IOUT	-	R	2	Linear	Returns the output current in amperes

PMBus™ SPECIFICATIONS

The LCM3000U-T Series Supported PMBus™ Command List:

Command Code	Command Name	Default Value	Access Type	Data Bytes	Data Format	Description
8Dh	READ_TEMPERATURE_1	-	R	2	Linear	Pri Hotspot
8Eh	READ_TEMPERATURE_2	-	R	2	Linear	Sec Hotspot
8Fh	READ_TEMPERATURE_3	-	R	2	Linear	Secondary Ambient
90h	READ_FAN_SPEED_1	-	R	2	Linear	
91h	READ_FAN_SPEED_2	-	R	2	Linear	
96h	READ_POUT	-	R	2	Linear	Returns the output power, in Watts
98h	PMBUS_REVISION	22	RB	1	Linear	
99h	MFR_ID	Artesyn	BR	-	ASCII	41,52,54,45,53,59,4E
9Ah	MFR_MODEL	LCM3000U-T	BR	-	ASCII	
9Bh	MFR_REVISION	-	BR	-	ASCII	
9Ch	MFR_LOCATION	-	BR	-	ASCII	
9Dh	MFR_DATE	-	BR	-	ASCII	
9Eh	MFR_SERIAL	-	BR	-	ASCII	
A0h	MFR_VIN_MIN	90	R	2	Linear	Minimum Input Voltage (90Vac)
A1h	MFR_VIN_MAX	264	R	2	Linear	Maximum Input Voltage (264Vac)
A2h	MFR_IIN_MAX	20	R	2	Linear	Maximum Input Current (20A)
A3h	MFR_PIN_MAX	3300	R	2	Linear	3300W
A4h	MFR_VOUT_MIN	27	R	2	Linear	
A5h	MFR_VOUT_MAX	45	R	2	Linear	
A6h	MFR_IOUT_MAX	83.375	R	2	Linear	Maximum Output Current
A7h	MFR_POUT_MAX	3000	R	2	Linear	Maximum Output Power
A8h	MFR_TAMBIENT_MAX	70	R	2	Linear	Maximum Operating Ambient Temperature (Secondary Ambient) (70 degC)
A9h	MFR_TAMBIENT_MIN	-40	R	2	Linear	Minimum Operating Ambient Temperature (Secondary Ambient) (-40 degC)
AAh	MFR_EFFICIENCY_LL	180,3000,85	BR	14	Linear	
ABh	MFR_EFFICIENCY_HL	230,3000,88	BR	14	Linear	
B0h	USER_DATA_B0	-	BR/W	-	Hex	
D9h	INH_EN LOGIC	00	R/W	1	B	Inhibit logic (0 Active Low, 1 Active High)
E1h	FW_SEC_VERSION	-	BR	8	ASCII	
E2h	CONFIG_UNLOCK_CODE	00,00,00,00,00	BR/W	4	ASCII	
F0h	PMBUS_IMP_SPEC_REVISION	-	BR	2	ASCII	
F1h	ISP_UNLOCK_CODE	00,00,00,00,00	BR/W	2	ASCII	
F2h	ISP_CTRL_CMD	-	R/W	1	B	
F3h	ISP_STATUS_BYTE	-	R	1	D	
F5h	ISP_FLASH_DATA	-	BR	16	H	

PMBus™ SPECIFICATIONS

The LCM3000W-T Series Supported PMBus™ Command List:

Command Code	Command Name	Default Value	Access Type	Data Bytes	Data Format	Description
00h	PAGE	-	R	1	H	
01h	OPERATION	80	R/W	1	B	Used to turn the unit ON/OFF in conjunction with the input INH_EN pin. Write 40h to turn off PSU, 80h to turn on the PSU
02h	ON_OFF_CONFIG	1E	R	1	B	Configures the combination of INH_EN pin and serial communication commands needed to turn the unit ON/OFF
03h	CLEAR_FAULTS	-	S	0	N/A	
10h	WRITE_PROTECT	80	R/W	1	B	Used to Control Writing to the PMBus Device 80h - Disables write 40h - Disables write except 00h, 01h 00 - Enables write to all writeable commands
15h	STORE_USER_ALL	-	S	0	N/A	Copies the Operating memory table to the matching USER non-volatile memory
1Bh	SMBALERT_MASK	0	BR/W	1/1 (R) 2 (W)	B	BMC - no alert
20h	VOUT_MODE	18	R	1	B	Specifies the mode and parameters of Output Voltage related Data Formats
21h	VPROG	48	R/W	2	Linear	Digital Voltage Programming
35h	VIN_ON	90	R	2	Linear	
36h	VIN_OFF	85	R	2	Linear	
3Bh	FAN_COMMAND_1	0	R/W	2	Linear	Read and write Fan rotation
40h	VOUT_OV_FAULT_LIMIT	64.797	R	2	Linear	Sets Output Over voltage threshold (64.797V)
41h	VOUT_OV_FAULT_RESPONSE	80	R	1	B	
42h	VOUT_OV_WARN_LIMIT	52.797	R	2	Linear	Sets Over-voltage Warning threshold(52.797V)
45h	VOUT_UV_FAULT_RESPONSE	78	R	1	B	
46h	IOUT_OC_FAULT_LIMIT	81.25	R	2	Linear	Sets the Over current threshold in Amps (81.25A)
47h	IOUT_OC_FAULT_RESPONSE	78	R	1	B	
4Fh	OT_FAULT_LIMIT	112	R	2	Linear	Secondary ambient temperature Fault threshold, in degree C (112degC)
50h	OT_FAULT_RESPONSE	C0	R	1	B	
51h	OT_WARN_LIMIT	108	R	2	Linear	Secondary ambient temperature warning threshold, in degree C. Operating limit (108degC)
6Ah	POUT_OP_WARN_LIMT	3452	R	2	Linear	

PMBus™ SPECIFICATIONS

The LCM3000W-T Series Supported PMBus™ Command List:

Command Code	Command Name	Default Value	Access Type	Data Bytes	Data Format	Description
78h	STATUS_BYTE	00	R	1	B	Returns the summary of critical faults
	b7 - BUSY					Not Supported
	b6 - OFF					Unit is OFF
	b5 - VOUT_OV_FAULT					Output over-voltage fault has occurred, will only be cleared when latching condition is removed
	b4 - IOUT_OC_FAULT					Not Supported
	b3 - VIN_UV_FAULT					Not Supported
	b2 - TEMPERATURE					A temperature fault or warning has occurred, will only be cleared when condition is removed
	b1 - CML					A communication, memory or logic fault has occurred
b0 - NONE OF THE ABOVE					Not Supported	
79h	STATUS_WORD	0000	R	2	B	Summary of units Fault and warning status
	b15 - VOUT					An output voltage fault or warning has occurred
	b14 - IOUT/POUT					An Output current or power fault or warning has occurred
	b13 - INPUT					Not Supported
	b12 - MFR_SPECIFIC					A manufacturer specific fault or warning has occurred
	b11 - POWER_GOOD#					The POWER_GOOD signal is de-asserted
	b10 - FANS					A fan or airflow fault or warning has occurred
	b9 - OTHERS					Not Supported
	b8 - UNKNOWN					Not Supported
	b7 - BUSY					Not Supported
b6 - OFF					Unit is OFF	

PMBus™ SPECIFICATIONS

The LCM3000W-T Series Supported PMBus™ Command List:

Command Code	Command Name	Default Value	Access Type	Data Bytes	Data Format	Description
79h	b5 - VOUT_OV_FAULT					Output over-voltage fault has occurred, will only be cleared when latching condition is removed
	b4 - IOUT_OC_FAULT					Not Supported
	b3 - VIN_UV_FAULT					Not Supported
	b2 - TEMPERATURE					A temperature fault or warning has occurred, will only be cleared when condition is removed
	b1 - CML					A communication, memory or logic fault has occurred
	B0 - NONE_OF_THE_ABOVE					Not Supported
7Ah	STATUS_VOUT	00	R/W	1	B	Output voltage related faults and warnings
	b7 - VOUT_OV_FAULT					VOUT Over--voltage Fault
	b6 - VOUT_OV_WARNING					VOUT Over--voltage Warning
	b5 - VOUT_UV_WARNING					Not Supported
	b4 - VOUT_UV_FAULT					VOUT Under-voltage Fault, asserts during short circuit condition and when output voltage reaches 35% of default value during constant current mode
	b3 - VOUT_MAX Warning					Not Supported
	b2 - TON_MAX_FAULT					TON_MAX_FAULT
	b1 - TOFF_MAX_WARNING					Not Supported
	b0 - VOUT Tracking Error					Not Supported
7Dh	STATUS_TEMPERATURE	00	R/W	1	B	Temperature related faults and warnings
	b7 - OT_FAULT					Over temperature Fault
	b6 - OT_WARNING					Over temperature Warning
	b5 - UT_WARNING					Not Supported
	b4 - UT_FAULT					Not Supported
	b3:0					reserved
7Eh	STATUS_CML	00	R/W	1	B	Communications, Logic and Memory
80h	STATUS_MFR_SPECIFIC	00	R/W	1	B	Manufacturer Status codes
81h	STATUS_FANS_1_2	00	R/W	1	B	
8Bh	READ_VOUT	-	R	2	Linear	Returns the actual, measured voltage in Volts
8Ch	READ_IOUT	-	R	2	Linear	Returns the output current in amperes

PMBus™ SPECIFICATIONS

The LCM3000W-T Series Supported PMBus™ Command List:

Command Code	Command Name	Default Value	Access Type	Data Bytes	Data Format	Description
8Dh	READ_TEMPERATURE_1	-	R	2	Linear	Pri Hotspot
8Eh	READ_TEMPERATURE_2	-	R	2	Linear	Sec Hotspot
8Fh	READ_TEMPERATURE_3	-	R	2	Linear	Secondary Ambient
90h	READ_FAN_SPEED_1	-	R	2	Linear	
91h	READ_FAN_SPEED_2	-	R	2	Linear	
96h	READ_POUT	-	R	2	Linear	Returns the output power, in Watts
98h	PMBUS_REVISION	22	RB	1	Linear	
99h	MFR_ID	Artesyn	BR	-	ASCII	41,52,54,45,53,59,4E
9Ah	MFR_MODEL	LCM3000W-T	BR	-	ASCII	
9Bh	MFR_REVISION	-	BR	-	ASCII	
9Ch	MFR_LOCATION	-	BR	-	ASCII	
9Dh	MFR_DATE	-	BR	-	ASCII	
9Eh	MFR_SERIAL	-	BR	-	ASCII	
A0h	MFR_VIN_MIN	90	R	2	Linear	Minimum Input Voltage (90Vac)
A1h	MFR_VIN_MAX	264	R	2	Linear	Maximum Input Voltage (264Vac)
A2h	MFR_IIN_MAX	20	R	2	Linear	Maximum Input Current (20A)
A3h	MFR_PIN_MAX	3300	R	2	Linear	3300W
A4h	MFR_VOUT_MIN	36	R	2	Linear	
A5h	MFR_VOUT_MAX	60	R	2	Linear	
A6h	MFR_IOUT_MAX	62.5	R	2	Linear	Maximum Output Current
A7h	MFR_POUT_MAX	3000	R	2	Linear	Maximum Output Power
A8h	MFR_TAMBIENT_MAX	70	R	2	Linear	Maximum Operating Ambient Temperature (Secondary Ambient) (70 degC)
A9h	MFR_TAMBIENT_MIN	-40	R	2	Linear	Minimum Operating Ambient Temperature (Secondary Ambient) (-40 degC)
AAh	MFR_EFFICIENCY_LL	180,3000,85	BR	14	Linear	
ABh	MFR_EFFICIENCY_HL	230,3000,88	BR	14	Linear	
B0h	USER_DATA_B0	-	BR/W	-	Hex	
D6h	IPROG	FFFE	R/W	2	Hex	Iprog Value
D9h	INH_EN LOGIC	00	R/W	1	B	Inhibit logic (0 Active Low, 1 Active High)
DAh	VPROG_SELECT	0	R/W	1	B	Digital Vprog Select (0:Analog 1: Digital)
E1h	FW_SEC_VERSION	-	BR	8	ASCII	
E2h	CONFIG_UNLOCK_CODE	00,00,00,00,00	BR/W	4	ASCII	
F0h	PMBUS_IMP_SPEC_REVISION	-	BR	2	ASCII	
F1h	ISP_UNLOCK_CODE	00,00,00,00,00	BR/W	2	ASCII	
F2h	ISP_CTRL_CMD	-	R/W	1	B	
F3h	ISP_STATUS_BYTE	-	R	1	D	
F5h	ISP_FLASH_DATA	-	BR	16	H	

PMBus™ SPECIFICATIONS

The LCM30007-T Series Supported PMBus™ Command List:

Command Code	Command Name	Default Value	Access Type	Data Bytes	Data Format	Description
00h	PAGE	-	R	1	H	
01h	OPERATION	80	R/W	1	B	Used to turn the unit ON/OFF in conjunction with the input INH_EN pin. Write 40h to turn off PSU, 80h to turn on the PSU
02h	ON_OFF_CONFIG	1E	R	1	B	Configures the combination of INH_EN pin and serial communication commands needed to turn the unit ON/OFF
03h	CLEAR_FAULTS	-	S	0	N/A	
10h	WRITE_PROTECT	80	R/W	1	B	Used to Control Writing to the PMBus Device 80h - Disables write 40h - Disables write except 00h, 01h 00 - Enables write to all writeable commands
15h	STORE_USER_ALL	-	S	0	N/A	Copies the Operating memory table to the matching USER non-volatile memory
1Bh	SMBALERT_MASK	0	BR/W	1/1 (R) 2 (W)	B	BMC - no alert
20h	VOUT_MODE	18	R	1	B	Specifies the mode and parameters of Output Voltage related Data Formats
35h	VIN_ON	90	R	2	Linear	
36h	VIN_OFF	85	R	2	Linear	
3Bh	FAN_COMMAND_1	0	R/W	2	Linear	Read and write Fan rotation
40h	VOUT_OV_FAULT_LIMIT	97.2	R	2	Linear	Sets Output Over voltage threshold (97.2V)
41h	VOUT_OV_FAULT_RESPONSE	78	R	1	B	
42h	VOUT_OV_WARN_LIMIT	79.156	R	2	Linear	Sets Over-voltage Warning threshold(79.156V)
45h	VOUT_UV_FAULT_RESPONSE	78	R	1	B	
46h	IOUT_OC_FAULT_LIMIT	53.938	R	2	Linear	Sets the Over current threshold in Amps (53.938A)
47h	IOUT_OC_FAULT_RESPONSE	78	R	1	B	
4Fh	OT_FAULT_LIMIT	112	R	2	Linear	Secondary ambient temperature Fault threshold, in degree C (112degC)
50h	OT_FAULT_RESPONSE This command is not preset in the Pmbus sof	C0	R	1	B	
51h	OT_WARN_LIMIT	108	R	2	Linear	Secondary ambient temperature warning threshold, in degree C. Operating limit (108degC)
6Ah	POUT_OP_WARN_LIMT	3452	R	2	Linear	

PMBus™ SPECIFICATIONS

The LCM30007-T Series Supported PMBus™ Command List:

Command Code	Command Name	Default Value	Access Type	Data Bytes	Data Format	Description
78h	STATUS_BYTE	00	R	1	B	Returns the summary of critical faults
	b7 - BUSY					Not Supported
	b6 - OFF					Unit is OFF
	b5 - VOUT_OV_FAULT					Output over-voltage fault has occurred Will only be cleared when latching condition is removed
	b4 - IOUT_OC_FAULT					Not supported
	b3 - VIN_UV_FAULT					Not supported
	b2 - TEMPERATURE					A temperature fault or warning has occurred Will only be cleared when condition is removed
	b1 - CML					A communication, memory or logic fault has occurred
	b0 - NONE OF THE ABOVE					Not supported
79h	STATUS_WORD	0000	R	2	B	Summary of units Fault and warning status.
	b15 - VOUT					An output voltage fault or warning has occurred
	b14 - IOUT/POUT					An Output current or power fault or warning has occurred.
	b13 - INPUT					Not Supported
	b12 - MFR_SPECIFIC					A manufacturer specific fault or warning has occurred.
	b11 - POWER_GOOD#					The POWER_GOOD signal is de-asserted
	b10 - FANS					A fan or airflow fault or warning has occurred.
	b9 - OTHERS					Not Supported
	b8 - UNKNOWN					Not Supported
	b7 - BUSY					Not Supported
	b6 - OFF					Unit is OFF

PMBus™ SPECIFICATIONS

The LCM30007-T Series Supported PMBus™ Command List:

Command Code	Command Name	Default Value	Access Type	Data Bytes	Data Format	Description
79h	b5 - VOUT_OV_FAULT					Output over-voltage fault has occurred
	b4 - IOUT_OC_FAULT					Not supported
	b3 - VIN_UV_FAULT					Not Supported
	b2 - TEMPERATURE					A temperature fault or warning has occurred
	b1 - CML					A communication, memory or logic fault has occurred.
	b0 - NONE_OF_THE_ABOVE					Not Supported
7Ah	STATUS_VOUT	00	R/W	1	B	Output voltage related faults and warnings
	b7 - VOUT_OV_FAULT					VOUT Over--voltage Fault
	b6 - VOUT_OV_WARNING					VOUT Over--voltage Warning
	b5 - VOUT_UV_WARNING					Not supported
	b4 - VOUT_UV_FAULT					VOUT Under-voltage Fault Asserts during short circuit condition and when output voltage reaches 35% of default value during constant current mode
	b3 - VOUT_MAX Warning					Not Supported
	b2 - TON_MAX_FAULT					TON_MAX_FAULT
	b1 - TOFF_MAX_WARNING					Not Supported
b0 - VOUT Tracking Error					Not Supported	
7Dh	STATUS_TEMPERATURE	00	R/W	1	B	Temperature related faults and warnings
	b7 - OT_FAULT					Over temperature Fault
	b6 - OT_WARNING					Over temperature Warning
	b5 - UT_WARNING					Not Supported
	b4 - UT_FAULT					Not Supported
	b3:0					Not Supported reserved
7Eh	STATUS_CML	00	R/W	1	B	Communications, Logic and Memory
81h	STATUS_FANS_1_2	00	R/W	1	B	
8Bh	READ_VOUT	-	R	2	Linear	Returns the actual, measured voltage in Volts
8Ch	READ_IOUT	-	R	2	Linear	Returns the output current in amperes

PMBus™ SPECIFICATIONS

The LCM30007-T Series Supported PMBus™ Command List:

Command Code	Command Name	Default Value	Access Type	Data Bytes	Data Format	Description
8Dh	READ_TEMPERATURE_1	-	R	2	Linear	Pri Hotspot
8Eh	READ_TEMPERATURE_2	-	R	2	Linear	Sec Hotspot
8Fh	READ_TEMPERATURE_3	-	R	2	Linear	Secondary Ambient
90h	READ_FAN_SPEED_1	-	R	2	Linear	
91h	READ_FAN_SPEED_2	-	R	2	Linear	
96h	READ_POUT	-	R	2	Linear	Returns the output power, in Watts
98h	PMBUS_REVISION	22	RB	1	Linear	
99h	MFR_ID	Artesyn	BR	-	ASCII	41,52,54,45,53,59,4E
9Ah	MFR_MODEL	LCM30007-T	BR	-	ASCII	
9Bh	MFR_REVISION	-	BR	-	ASCII	
9Ch	MFR_LOCATION	-	BR	-	ASCII	
9Dh	MFR_DATE	-	BR	-	ASCII	
9Eh	MFR_SERIAL	-	BR	-	ASCII	
A0h	MFR_VIN_MIN	90	R	2	Linear	Minimum Input Voltage (90Vac)
A1h	MFR_VIN_MAX	264	R	2	Linear	Maximum Input Voltage (264Vac)
A2h	MFR_IIN_MAX	20	R	2	Linear	Maximum Input Current (20A)
A3h	MFR_PIN_MAX	3300	R	2	Linear	3300W
A4h	MFR_VOUT_MIN	54	R	2	Linear	
A5h	MFR_VOUT_MAX	90	R	2	Linear	
A6h	MFR_IOUT_MAX	41.67	R	2	Linear	Maximum Output Current
A7h	MFR_POUT_MAX	3000	R	2	Linear	Maximum Output Power
A8h	MFR_TAMBIENT_MAX	70	R	2	Linear	Maximum Operating Ambient Temperature (Secondary Ambient) (70 degC)
A9h	MFR_TAMBIENT_MIN	-40	R	2	Linear	Minimum Operating Ambient Temperature (Secondary Ambient) (-40 degC)
AAh	MFR_EFFICIENCY_LL	180,3000,85	BR	14	Linear	
ABh	MFR_EFFICIENCY_HL	230,3000,88	BR	14	Linear	
B0h	USER_DATA_B0	-	BR/W	-	Hex	
D9h	INH_EN LOGIC	00	R/W	1	B	Inhibit logic (0 Active Low, 1 Active High)
E1h	FW_SEC_VERSION	-	BR	8	ASCII	
E2h	CONFIG_UNLOCK_CODE	00,00,00,00,00	BR/W	4	ASCII	
F0h	PMBUS_IMP_SPEC_REVISION	-	BR	2	ASCII	
F1h	ISP_UNLOCK_CODE	00,00,00,00,00	BR/W	2	ASCII	
F2h	ISP_CTRL_CMD	-	R/W	1	B	
F3h	ISP_STATUS_BYTE	-	R	1	D	
F5h	ISP_FLASH_DATA	-	BR	16	H	

APPLICATION NOTES

Current Sharing and Parallel Operation

The LCM3000 series main output V1 is equipped with current sharing capability. This will allow up to 8 power supplies to be connected in parallel for higher power application. Current share accuracy are not critical.

PSU has OR'ing FET built in.

The minimum load at parallel operation is 0% of the total Output current that the units can deliver. With constant current behavior, units in parallel must start up into the total applied load.

The table below shows the derated maximum power capacity when units are in parallel configuration. This is to consider the 10% load sharing tolerance.

Number of Units in Parallel (N)	Maximum Output power Rated + [(N-1) x 0.9] x Rated, Where: Rated - 3000W, N - Number of PSU in Parallel
Stand-alone	3000W
2	5700W
3	8400W
..	..
....
8	21900W

APPLICATION NOTES

Digital Vprog

The Power supplies support digital Vprog that set the output voltage through PMBus command. By changing the Vprog select from analog to digital first, the output voltage can range from 40% of V_O (nominal voltage) up to 125% of V_O . Digital Vprog are only implemented on LCM3000L,Q and W only.

Digital Vprog Procedures:

1. Connect the input AC cables to LCM3000X-T, loading cables from output terminal of LCM3000X-T to electronics load, and 20 pin Header Connector to I2C tools (SDA,SCL,GND).
2. Apply AC input voltage to LCM3000X-T.
3. Open your preferred GUI for your available I2C tools.

4. Send following Commands:

a. Write Enable

write enable	<input checked="" type="checkbox"/>	6	ST	0xBE	Write	10, 00	Yes
--------------	-------------------------------------	---	----	------	-------	--------	-----

b. Send Passcode: "User"

key User	<input checked="" type="checkbox"/>	7	ST	0xBE	Write	E2,04,55,73,65,72	Yes
----------	-------------------------------------	---	----	------	-------	-------------------	-----

c. Send Digital Vprog Select Command (0: Analog Vprog 1: Digital Vprog)

0 analog 1 digital	<input checked="" type="checkbox"/>	7	ST	0xBE	Write	DA, 01	Yes
--------------------	-------------------------------------	---	----	------	-------	--------	-----

d. Send Target Digital Vprog Value in Voltage Linear Format

12	<input checked="" type="checkbox"/>	13	ST	0xBE	Write	21,00,C	Yes
----	-------------------------------------	----	----	------	-------	---------	-----

e. Send Save Command

save	<input checked="" type="checkbox"/>	8	ST	0xBE	Write	15	Yes
------	-------------------------------------	---	----	------	-------	----	-----

5. Verify the actual new output voltage of the LCM3000X-T.

APPLICATION NOTES

Current Programming (Iprog)

Constant Current Operation of the power supply can be configured digitally from 10% of $I_{O,max}$ (3000W) up to 115% $I_{O,max}$. Iprog setting has accuracy of 6% from the target Iprog Set. Constant Current of the power supply can operate from output voltage down to 35% V_O . With the proper command, Iprog setting can be stored permanently.

Below 35% V_O with Constant Current Operation, power supply can enter hiccup mode/retry mode. Below 10% Iprog Set will turn off the main output of the power supply. Iprog are only implemented on LCM3000L,Q and W only.

Iprog Procedures:

1. Connect the input AC cables to LCM3000X-T, loading cables from output terminal of LCM3000X-T to electronics load, and 20 pin Header Connector to I2C tools (SDA,SCL,GND).
2. Apply AC input voltage to LCM3000X-T.
3. Open your preferred GUI for your available I2C tools.
4. Send following Commands:

a. Write Enable

write enable	<input checked="" type="checkbox"/>	6	ST	0xBE	Write	10, 00	Yes
--------------	-------------------------------------	---	----	------	-------	--------	-----

b. Send Passcode: "User"

key User	<input checked="" type="checkbox"/>	7	ST	0xBE	Write	E2,04,55,73,65,72	Yes
----------	-------------------------------------	---	----	------	-------	-------------------	-----

c. Send Target Iprog Value (Ampere) in Linear Format (Factory Default: 0xFFFE) 60A = 0xE3C0

60A	<input checked="" type="checkbox"/>	34	ST	0xBE	Write	D6,C0,E3	Yes
-----	-------------------------------------	----	----	------	-------	----------	-----

d. Send Save Command

save	<input checked="" type="checkbox"/>	8	ST	0xBE	Write	15	Yes
------	-------------------------------------	---	----	------	-------	----	-----

5. Verify the actual new constant current operation of LCM3000X-T using the CV mode of the E-load. (Please do AC recycle)

APPLICATION NOTES

Configurable Inhibit

PS_INHIBIT / ENABLE signal function can be configurable through PMBus.

Configurable Inhibit Procedures:

1. Connect the input AC cables to LCM3000X-T, loading cables from output terminal of LCM3000X-T to electronics load, and 20 pin Header Connector to I2C tools (SDA,SCL,GND).
2. Put a switch on INH EN and GND.
3. Apply AC input voltage to LCM 3000X-X.
4. Open your preferred GUI for your available I2C tools.
5. Send following Commands:

a. Write Enable

write enable	<input checked="" type="checkbox"/>	6	ST	0xBE	Write	10, 00	Yes
--------------	-------------------------------------	---	----	------	-------	--------	-----

b. Send Target Inhibit Logic (Factory Default: 0x00)

0:Active Low 1: Active High	<input checked="" type="checkbox"/>	4	ST	0xBE	Write	D9, 00	Yes
-----------------------------	-------------------------------------	---	----	------	-------	--------	-----

Command 0xD9 to change inhibit logic

0 - Active Low

1 - Active High

6. Verify the actual respond of the main output to the INH_EN logic.

APPLICATION NOTES

Output Ripple and Noise Measurement

The setup outlined in the diagram below has been used for output voltage ripple and noise measurements on the LCM3000 series. When measuring output ripple and noise, a scope jack in parallel with a 0.1uF ceramic chip capacitor, and a 10 uF tantalum capacitor should be used. Oscilloscope should be set to 20 MHz bandwidth for this measurement.

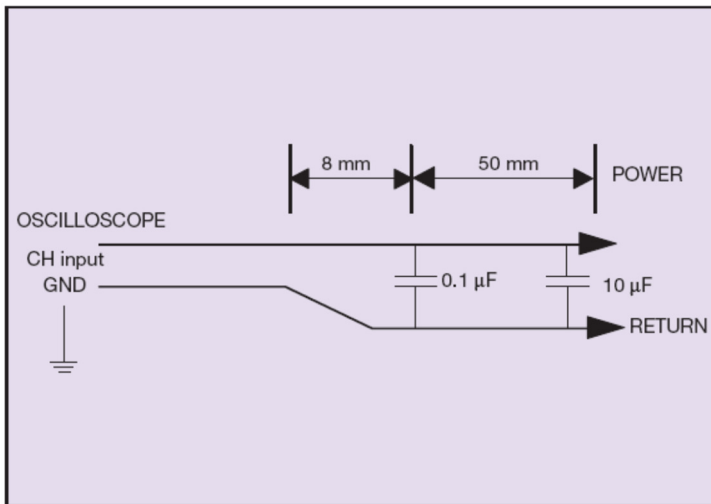

RECORD OF REVISION AND CHANGES

Issue	Date	Description	Originators
1.0	12.12.18	First Issue	C. Yan K. Ma
1.1	04.30.19	Delete Excess Option Item and Add Derating Info	C. Yan
1.2	05.09.19	Update Mating Connector Update the PFC Frequency	K. Wang
1.3	05.15.19	Remove Reverse Air Option	C. Yan
1.4	06.25.19	Remove Excess Option Item	C. Yan
1.5	01.02.20	Update Model LCM3000Q, LCM3000U	C. Yan
1.6	03.11.20	Add Features Iprog and Digital Vprog Add INHIBIT / ENABLE Logic Configurability	C. Yan
1.7	03.27.20	Add Production Isolation Voltage Specification	C. Yan
1.8	04.15.20	Remove Maximum Start up Power	C. Yan
1.9	04.30.20	Update Vprog trim note	C. Yan
2.0	06.18.20	Update Safety Certifications	C. Yan
2.1	07.31.20	Add a note of customer mounting screw	K. Wang
2.2	05.20.21	Add the label location	K. Wang
2.3	07.07.21	Update the typo	K. Wang
2.4	08.10.21	Update the isolation voltage and new picture with new logo	K. Wang
2.5	03.30.22	Update UKCA Mark Update T7 Description Update Timing Diagram Update Total Regulation Update the PMBus Logo Update I2C Clock Frequency Update Output Mating Connector Add Performance Curve and Command List of LCM30008/7	K. Jiao
2.6	04.18.23	Update thermistor information Update input frequency Add Semi F47 compliance at high line Update LCM30007-T adjustment range	K. Ma



For international contact information,
visit advancedenergy.com.

powersales@aei.com (Sales Support)
productsupport.ep@aei.com (Technical Support)
+1 888 412 7832

ABOUT ADVANCED ENERGY

Advanced Energy (AE) has devoted more than three decades to perfecting power for its global customers. AE designs and manufactures highly engineered, precision power conversion, measurement and control solutions for mission-critical applications and processes.

Our products enable customer innovation in complex applications for a wide range of industries including semiconductor equipment, industrial, manufacturing, telecommunications, data center computing, and medical. With deep applications know-how and responsive service and support across the globe, we build collaborative partnerships to meet rapid technological developments, propel growth for our customers, and innovate the future of power.

PRECISION | POWER | PERFORMANCE | TRUST

Specifications are subject to change without notice. Not responsible for errors or omissions. ©2020 Advanced Energy Industries, Inc. All rights reserved. Advanced Energy®, and AE® are U.S. trademarks of Advanced Energy Industries, Inc.